

Photoelectric sensors. Fiber optics and fiber optic sensors.

Precise, measurably better. Edition 2013



Photoelectric sensors
by Baumer combine
tried and tested
technology
and sophisticated
innovations.

Visibly better: Baumer sensors.

The Baumer Group is leading at international level in the development and production of sensors, shaft encoders, measuring instruments as well as components for automatic image processing. As an owner-managed family business, we employ about 2500 workers worldwide in 36 subsidiaries and 18 countries. With marked customer orientation, consistently high quality and vast innovation potential worldwide, Baumer develops specific solutions for many industries and applications.

Our standards – your benefits.

- Passion coupled with expertise – both have made us a sensor pioneer and technology leader
- Our range of services is hard to beat – we have the right product, developed by our own team, for every task
- Inspiring through innovation – a challenge Baumer employees take on every day
- Reliability, precision and quality – our customers' requirements are what drives us
- Partnership from the start – together with our customers we develop suitable solutions
- Always a step ahead – thanks to our production depth, our flexibility and our delivery reliability
- Available worldwide – Baumer is Baumer everywhere



Photoelectric sensors detect objects, measure distances, recognize colors, count components and monitor filling levels. Manufacturing newspapers, chocolate, cars, computers and cell phones would be inconceivable without sensors. Delivering letters and packages would be extremely time-consuming and processing food would be cumbersome.

State of technology:

- Today's technology makes it possible to produce compact photoelectric sensors that are able to precisely detect objects with high repeat accuracy even in harsh, industrial environments.
- User-friendly Smart Vision sensors enable objects to be checked in a two-dimensional plane.

Photoelectric sensors from Baumer:

- Baumer offers a wide range of photoelectric sensors for countless applications.
- Complete line of sensors for the food and beverage industry in a washdown or hygienic design
- SmartReflect light barriers offer the most reliable and most convenient type of object detection
- Light barriers and diffuse sensors, also with background suppression if needed, are available in the smallest designs

- Laser technology is also available in nearly every type of sensor
- Broad range of fiber optic sensors and plastic and glass fiber optics
- Distance-measuring laser sensors with high resolution of up to 2 µm and measuring distances of up to 13 m provide precise, absolute distance information
- Line sensors with integrated processing electronics check edge position of textile webs, detect objects in a two-dimensional plane, or provide absolute and precise position information
- Compact vision sensors for position, completeness and placement monitoring. Sensors for specific applications such as the laser SCATEC copy counter
- Customer-oriented solutions for specific requirements

Baumer is the right partner for you when it comes to efficient and competitive photoelectric sensor solutions.

Ask us!



Learn more.
Downloadable data sheets as well as further information about our products is available at:
www.baumer.com/photoelectric



Contents.

Introduction

| | |
|--|----|
| Photoelectric sensors in miniature housings | 8 |
| Photoelectric distance-measuring sensors | 10 |
| Photoelectric laser sensors | 12 |
| Photoelectric sensors for the food and beverage industry | 14 |

Distance and intensity-based

| | |
|---|-----|
| Photoelectric distance measuring sensors | 20 |
| Difference sensors | 78 |
| Diffuse sensors with background suppression | 88 |
| Diffuse sensors with intensity difference | 144 |
| Level monitoring and leak detecting sensors | 184 |

Light barriers

| | |
|------------------------------------|-----|
| <i>SmartReflect</i> light barriers | 198 |
| Retro-reflective sensors | 214 |
| Through beam sensors | 250 |
| Fork and angle sensors | 282 |

Fiber optics and fiber optic sensors

| | |
|-----------------------------|-----|
| Plastic fiber optic sensors | 304 |
| Plastic fiber optics | 324 |
| Glass fiber optic sensors | 333 |
| Glass fiber optics | 340 |

Vision sensors Edge/Profile recognition

| | |
|--|-----|
| Vision sensors <i>VeriSens</i> [®] | 352 |
| <i>ParCon</i> and <i>PosCon</i> line sensors | 365 |
| <i>SCATEC</i> copy counter / edge sensor | 378 |

Color/Contrast recognition

| | |
|--------------------------|-----|
| LOGIPAL color sensors | 398 |
| Diffuse contrast sensors | 404 |

Accessories

| | |
|----------------------------------|-----|
| Connectors and mating connectors | 420 |
| Connectors / pin assignment | 425 |
| Reflectors | 426 |
| Divers | 431 |
| Mounting accessories | 433 |
| Mounting kits <i>Sensofix</i> | 437 |
| Hygienic and washdown | 439 |
| Fiber optics | 441 |

Glossary

| | |
|--|-----|
| | 446 |
|--|-----|

| | |
|----------------------|-----|
| Quick reference list | 456 |
|----------------------|-----|



Baumer – setting standards with innovations.

The success story of the Baumer Group is characterized by innovations. By hardware and software engineers, designers or process engineers who work day in and day out to make our products and systems even better.

We pay particular attention to the increased miniaturization, precision as well as the measuring speed and robustness of the sensors. These features characterize our products even today. And that is something we are proud of.

The Baumer development teams are organized in an international network and are in close contact with well-known universities, recognized research institutes and highly specialized international engineering companies. As the technological leader, Baumer always endeavors to maintain its lead over the long term and protect its numerous innovations through patents.



Comprehensive product range

- Actuators and positioning drives
- Capacitive proximity sensors
- Conductivity sensors
- Counters
- Digital cameras
- Encoders
- Force and strain sensors
- Inductive sensors
- Level measurement
- Magnetic sensors
- Network Components
- OCR and code reader systems
- Optical inspection systems
- Photoelectric sensors
- Precision switches My-Com
- Pressure measurement
- Process analysis
- Process displays
- Resolvers
- Speed switches
- Spindle positioning systems
- Tachogenerators
- Temperature sensors
- Ultrasonic sensors
- Vision sensors



- Inductive sensors
- Capacitive sensors
- Photoelectric sensors
- Vision sensors
- Ultrasonic sensors
- Magnetic sensors
- Precision switches
My-Com

Passion for sensors.

Whether for object or position recognition, measuring, a miniaturized or exceptionally robust design – Baumer has the right sensor for every application. Different sensor functions in standard housings ease assembly for the user and limit the setup time to a minimum. Baumer can supply a wide range from inductive to vision sensors and advise you comprehensively.

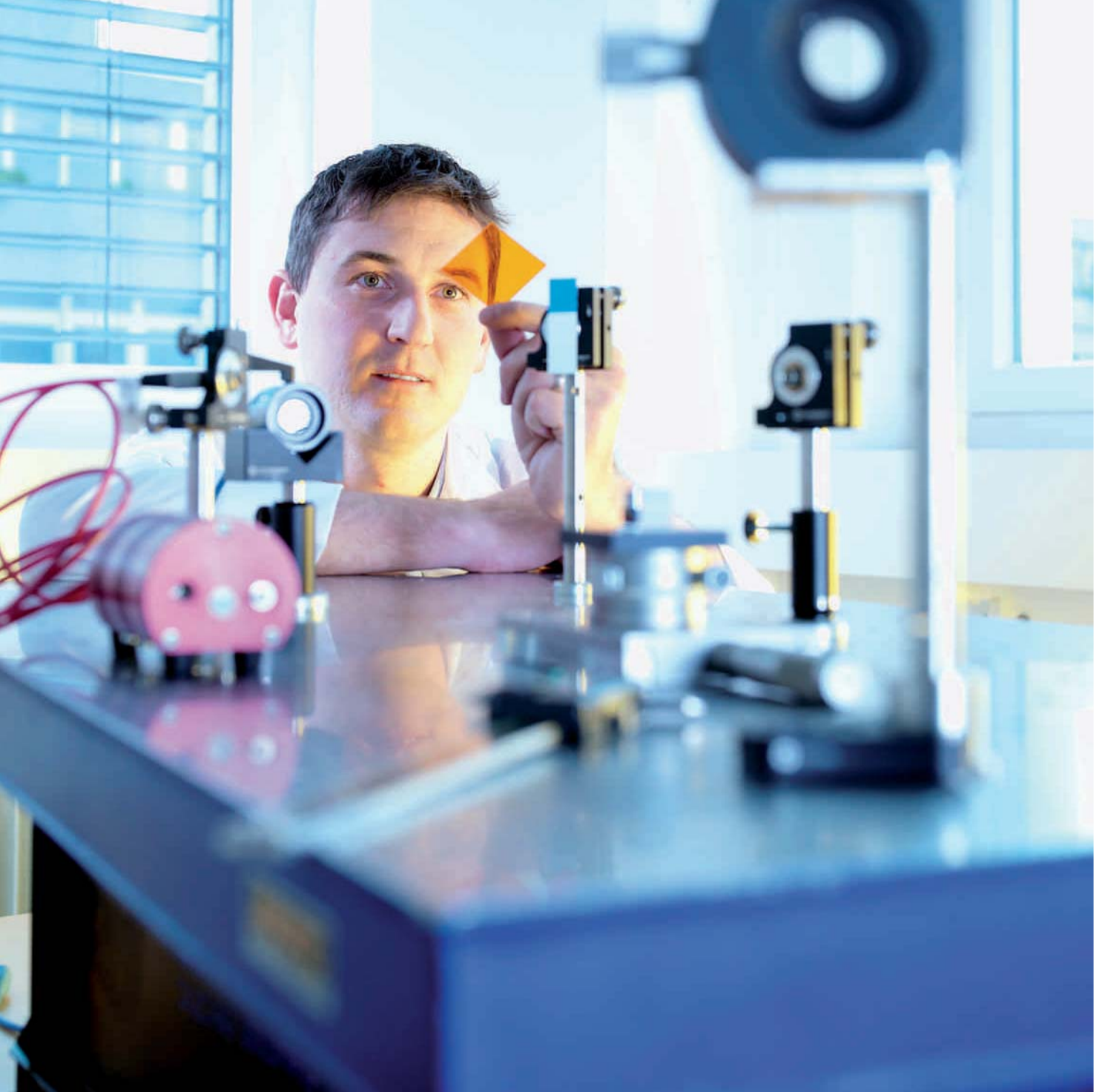

Customized solutions.

Our broad range of products enables us to provide the optimum solution for a large number of applications. But customers might have needs completely outside these application areas that cannot be entirely satisfied by the products currently on the market.

And this is precisely why our development engineers work closely with our customers. In searching for optimum solutions to meet these special needs, we are able to create customized solutions. Our customized solutions range from special mechanical designs to completely new sensor systems.

An innovative sensor solution can also help you gain a significant competitive advantage.

We would be happy to advise you!



Photoelectric sensors in miniature housings



- FHDK 04: smallest sensor on the market with real background suppression (4 x 6 x 45 mm)
- Smallest line of sensors with an adjustable switching distance (*MINOS*)
- Smallest laser sensors with background suppression and adjustable sensing distance (*OHDK 10*)
- Series 10 miniatures: widest range of products with the best performance



- Whether through teach-in keys or potentiometers: all sensors (even the smallest) can be easily and precisely configured according to the application



- Sensors with beam diameters of up to 0.1 mm can identify the smallest objects or detect parts with the utmost precision regardless of color or objects in the background.



- Large selection of different plastic and glass fiber optics for solving even the most difficult applications
- Custom designed fiber optic heads
- Different fiber optic amplifiers: device ranging from easily adjustable to powerful with multiple modes

Applications

- Installation/handling
- Semiconductor manufacturing
- Packaging machines
- Measuring/testing technology
- Graphic machines

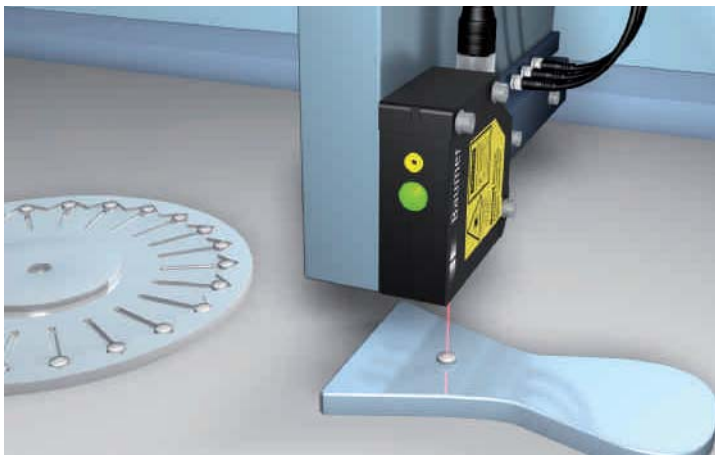

Laser distance sensor

- Measuring tablet thickness.

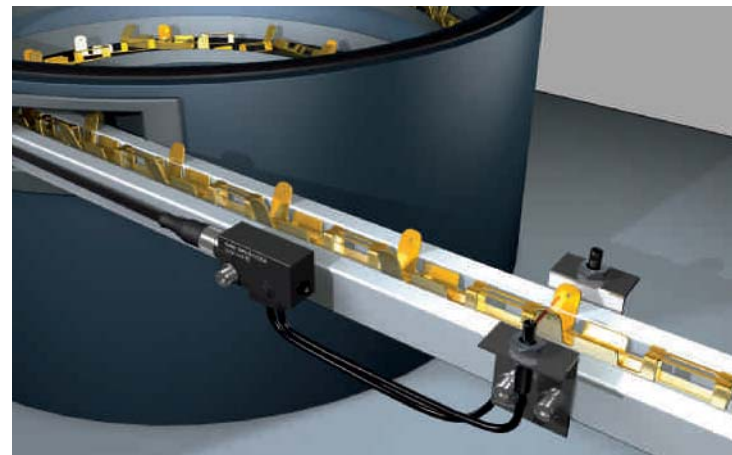

Small fiber optic head

- Detecting small parts on a handling machine.



SmartReflect™ Light barriers

- Positioning the lipstick tube before the filling.

Miniaturization is an unstoppable trend. Faster processes, better quality and increasingly more integrated machines require more precise and compact sensors. Our uniquely small sensors are the perfect fit for applications where detecting objects in this position and at this location has previously seemed to be impossible.

No place is too cramped and no application is too difficult for Baumer's miniature sensors to handle.

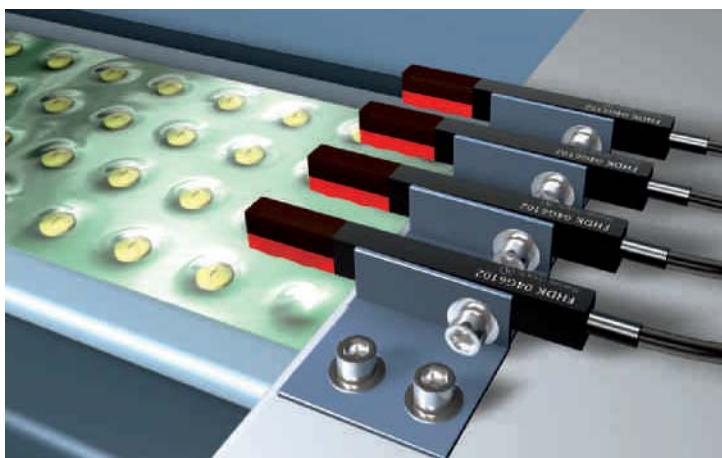

Diffuse sensors with background suppression

- Presence check of tablets.

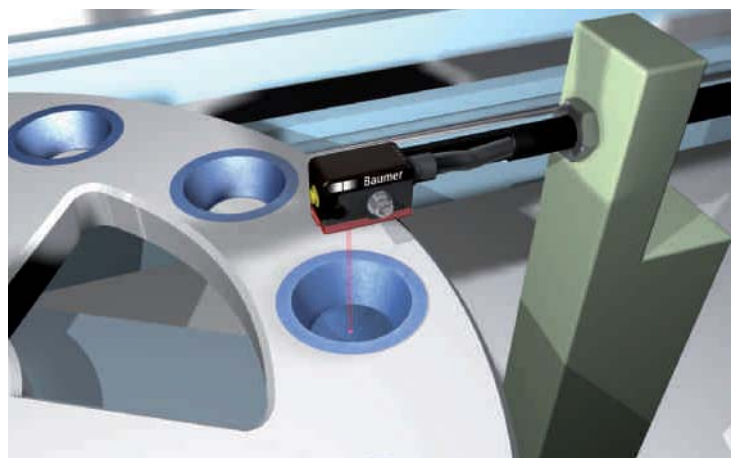

Diffuse sensors with intensity difference

- Presence check of filters in the coffee capsules.

Photoelectric distance-measuring sensors

Many applications need a lot more information than just whether an object is present. Our sensors can provide precise measurements at high cycle times even with difficult surfaces. So distances, widths, heights, positions and diameters of objects can be measured with the utmost precision and high resolution.

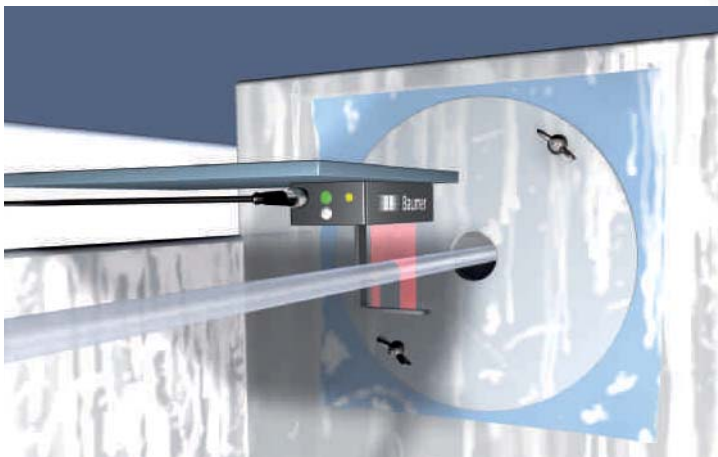
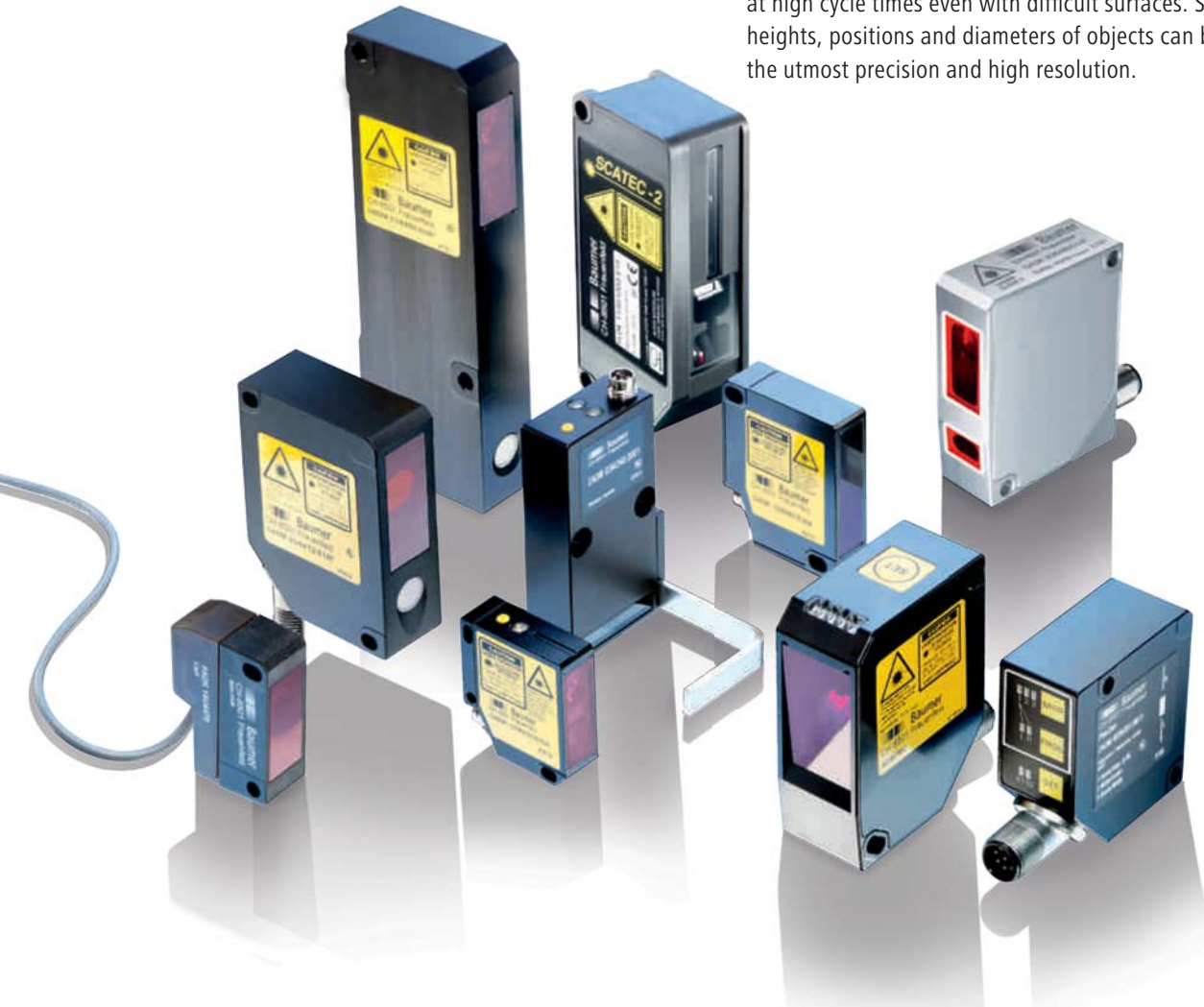

ParCon line sensor

- Diameter monitoring during plastic rod extrusion process.

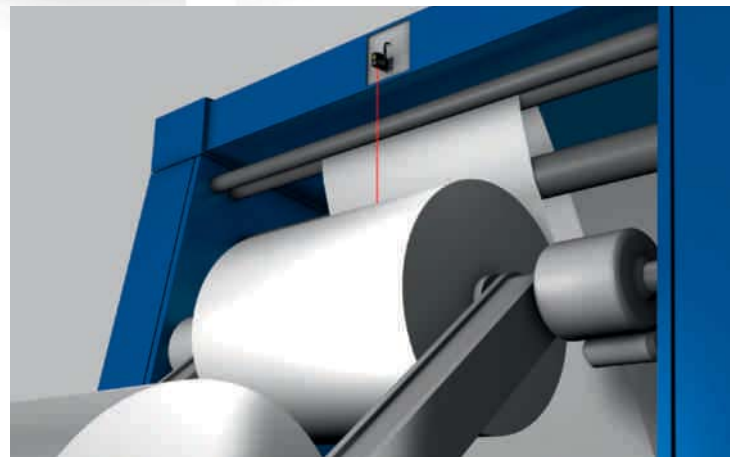

Laser distance sensor

- Diameter monitoring with a narrow paper roll.

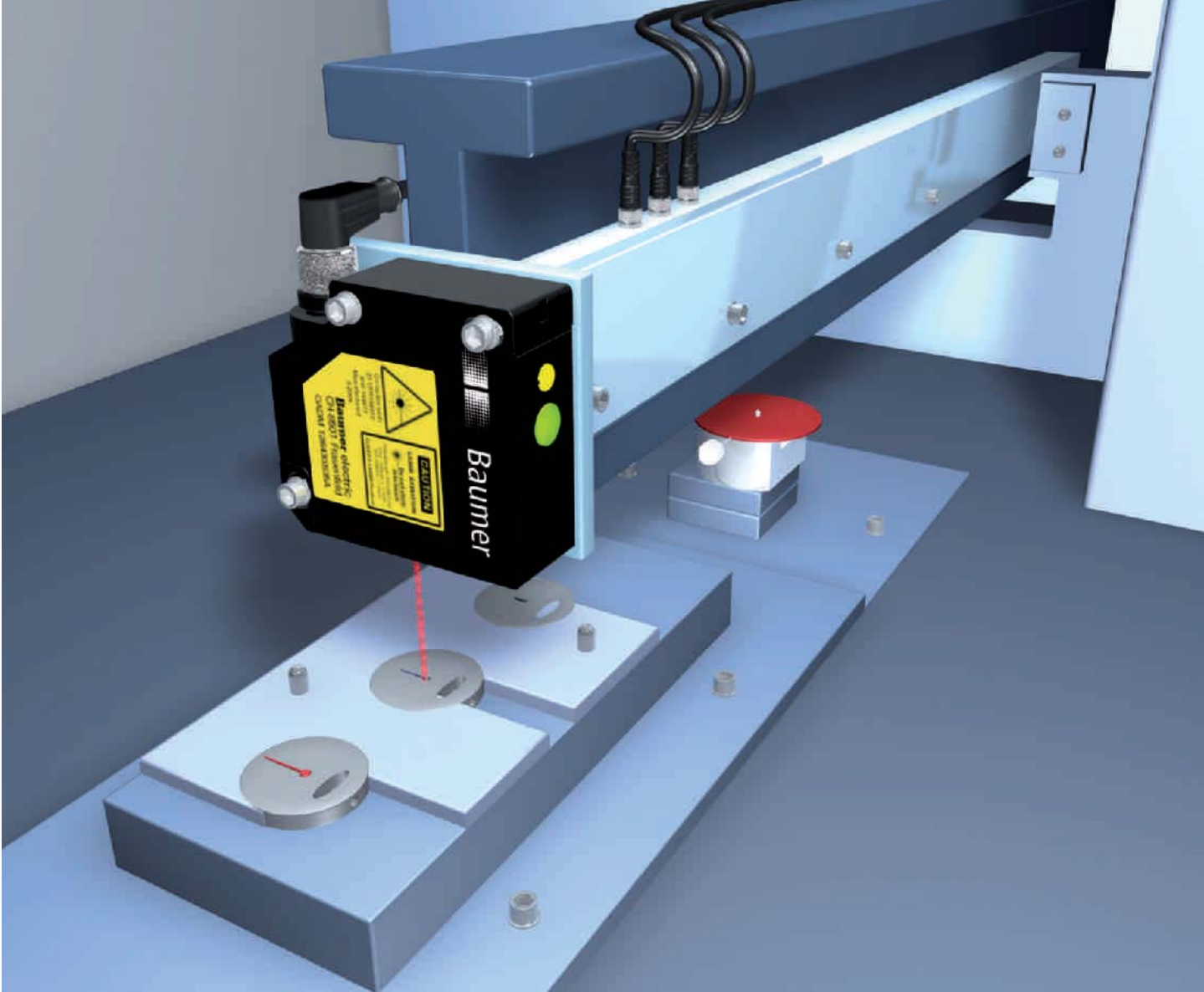

Laser distance sensor

- Distance measuring on dial plate to determine the precise press-in depth for the indicator.

Applications

- Machine tool building
- Installation/handling
- Semiconductor manufacturing
- Packaging machines
- Measuring/testing technology
- Textile machines
- Graphic machines
- Commercial vehicles



- CCD line sensor with integrated processing electronics in compact metal housing
- *ParCon* measures web edges or object widths in the 24 mm range
 - *PosCon* measures web edges or object widths in the 30–350 mm range
 - High resolution (of up to 0.03 mm)



- Distance-measuring sensor with integrated processing electronics in highly compact metal housing
- Distance measurement from 0.02 m to 1 m
 - Maximum resolution of 0.002 mm
 - Incredibly short response time of 0.9 ms.

- Possible to optimize the resolution by limiting the measuring range
- Precise distance measurement regardless of object's color or surface

Photoelectric laser sensors

Applications

- Machine tool building
- Installation/handling
- Semiconductor manufacturing
- Packaging machines
- Measuring/testing technology
- Textile machines
- Graphic machines
- Plastics machines



- Small, clearly visible light spot
- Laser class 1 or 2
- Laser diode service life of up to 100,000 hours



- Fast and precise object detection
- High repeat accuracy in sensing and measuring
- Best laser sensor in its class with background suppression (OHDM 12)



- Smallest laser sensor with background suppression and adjustable sensing distance (OHDK 10)
- Retro-reflective sensor with single lens optics
- Smallest laser distance sensor with integrated processing electronics (OADM 12)
- Wide range of laser distance sensors in various housing sizes



- Laser copy counters (SCATEC): counting up to 3 million copies of newspapers per hour
- Counting individual sheets up to 0.1 mm thick
- Individual package detection with seamless product conveyance

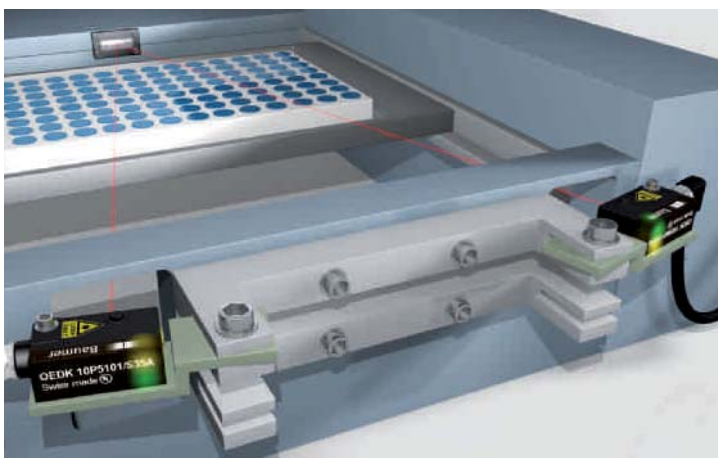

Through beam laser sensor

- Monitoring the top edge of a rack for small parts.

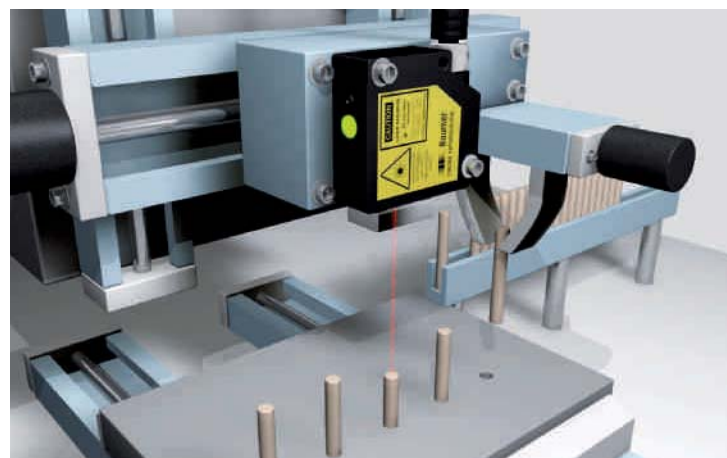

Laser differential sensor

- Detecting when height differences of pressed-in pins are too large.

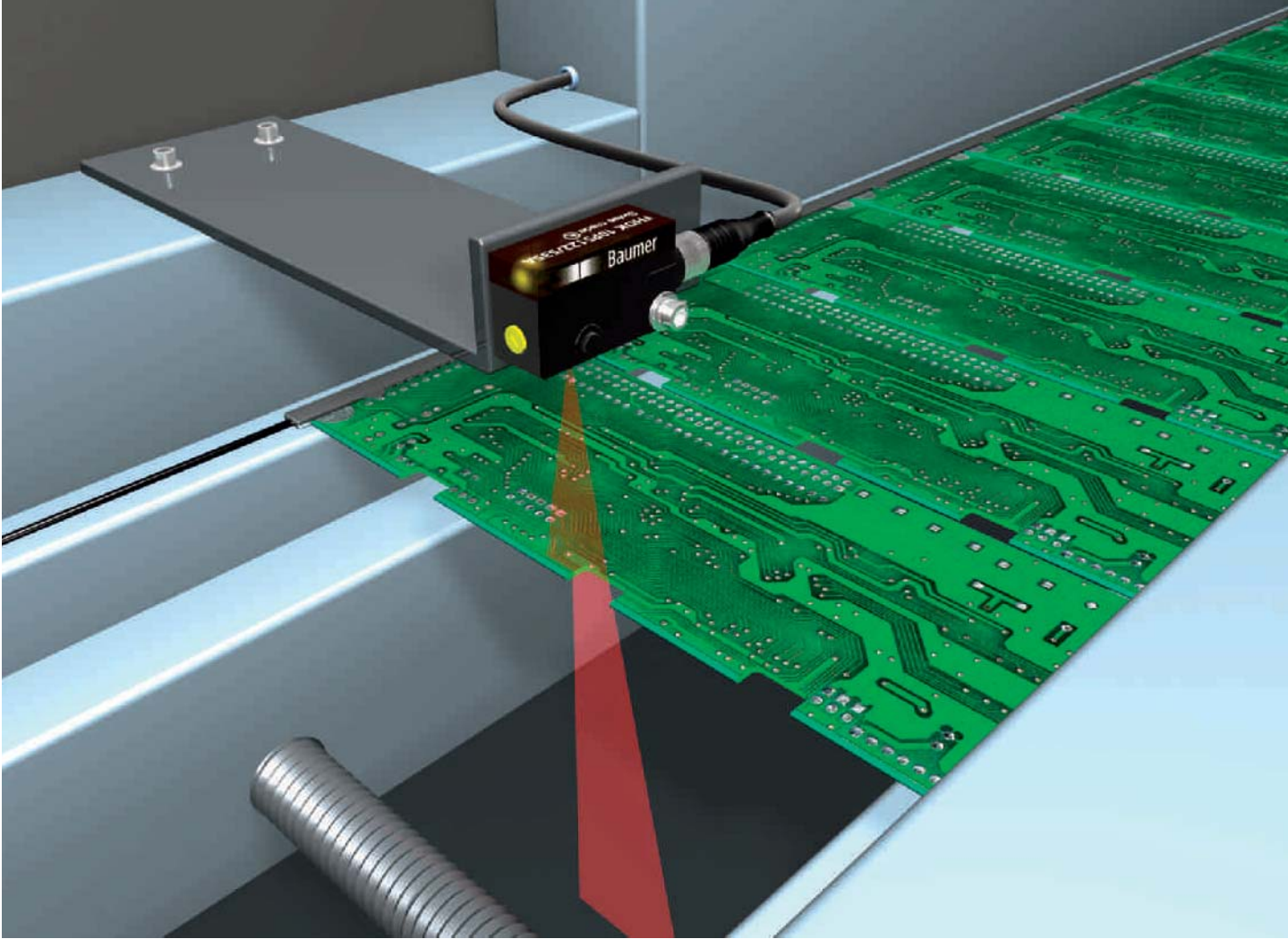

Diffuse laser sensor

- Reliable edge detection of a printed circuit board via line optics.

It is able to detect the smallest parts. Objects can also be identified through very narrow slits. All because laser sensors are able to detect the smallest objects at incredible distances thanks to their acute, intensive light beam.

They are also able to do so regardless of whether the scanner works with background suppression, retro-reflective sensor with single lens optics or through beam sensor.



SCATEC copy counter / edge detector

- Precise triggering with seamless product conveyance
- Counting of individual packages / copies



Laser distance sensor

- Capturing information on shelf contents within an automated warehouse.

Photoelectric sensors for the food and beverage industry.

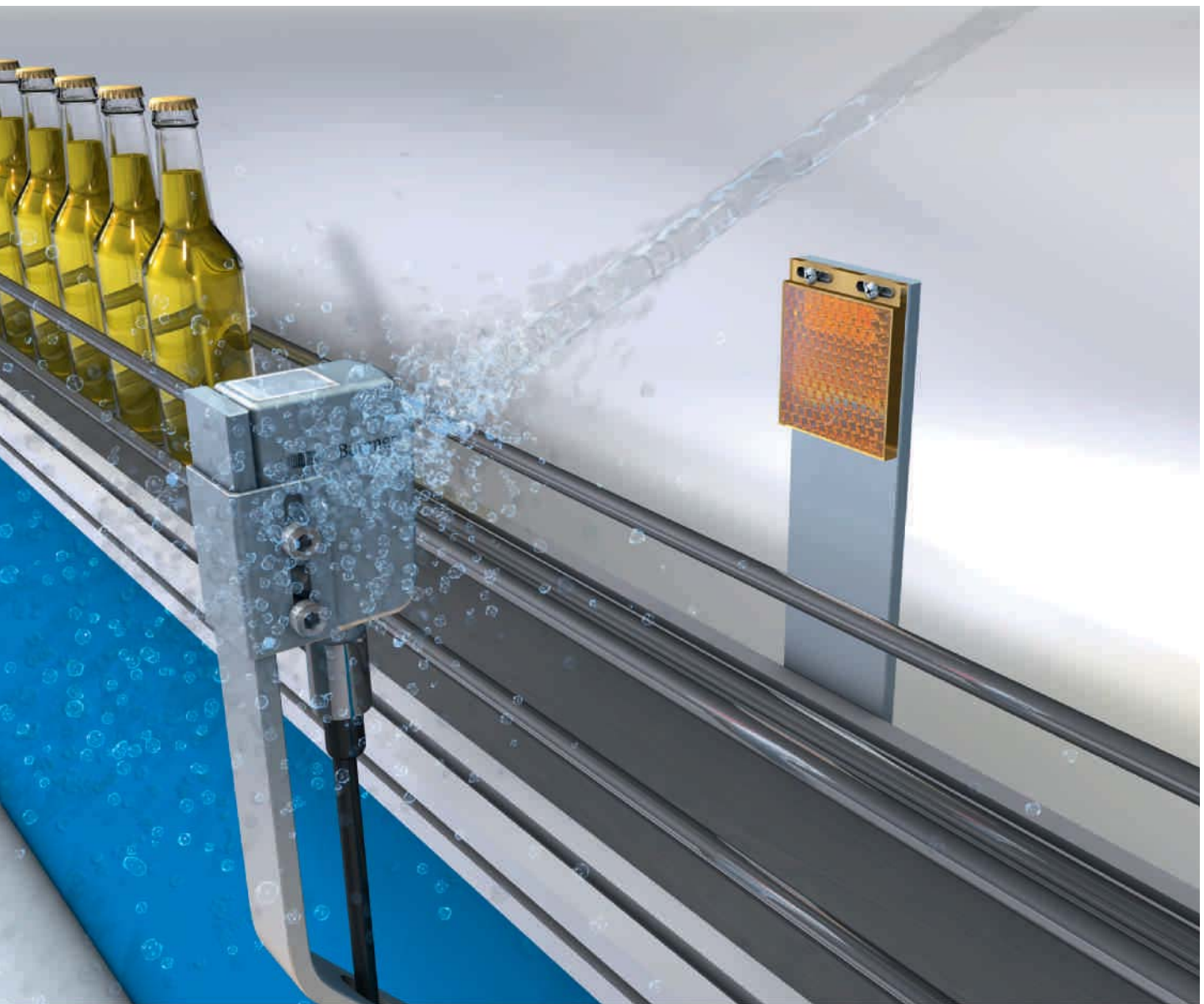

Photoelectric sensors for the food and beverage industry meet strict standards and regulations. We only use FDA-compliant materials, and we make sure they are chemically resistant to cleaning agents. The housings are made of V4A stainless steel with a roughness factor of $\leq 0.8 \mu\text{m}$ so that no microbial residue can accumulate.

The sensors are available in two different housing designs for the two different areas in which the machines are used.

Hygienic design for the food area

EHDG-certified design any residue that might start to accumulate is reliably removed when the hygienic design is cleaned.

Washdown design for the splash zone

Sensors for the splash zone meet the same strict criteria as sensors for the food area. However, no hygienic design is required since no residue is able to find its way back into the flow of production.

SmartReflect – Light barriers without reflectors

These light barriers work by reflecting off a machine part. In other words, the sensor provides the reliable object detection of a light barrier but does not need a reflector. Machine down-times caused by a damaged reflector can thus be completely avoided.

Production areas

- Food processing
- Food storage
- Food packaging
- Filling
- Quality control



Unique proTect+ impermeability concept guarantees impermeability even after significant temperature cycles; high reliability and a long service life



Ecolab-tested and FDA-compliant for reliable chemical resistance to cleaning agents and consistent use of materials that conform to food standards and regulations



Operating temperature range up to 60 °C facilitates versatile use and results in long service life even with high temperatures.



Stainless steel housing V4A with protection class IP 69K for incredible robustness and a long service life



Integral hygienic design of sensors and fitting accessories meets design guidelines for hygienic applications, enables them to be used in immediate proximity to food, and simplifies the certification process for machines



Laser inscription ensures that the sensor can always be clearly identified

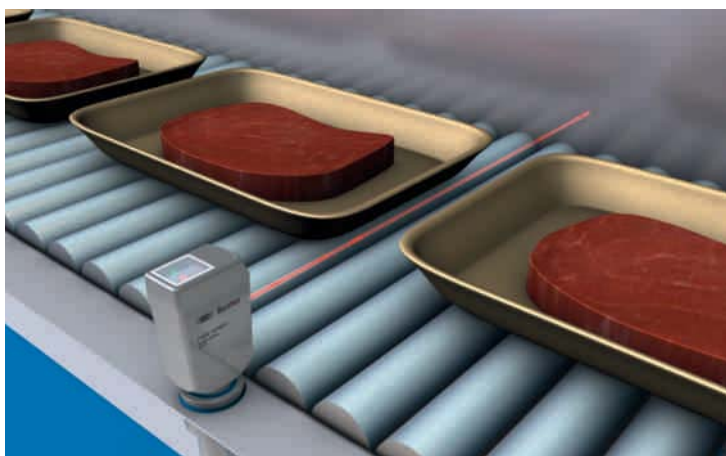

SmartReflect™ sensor

- The *SmartReflect™* detects the meat trays on the conveyor belt and uses a machine part as a reflection reference.

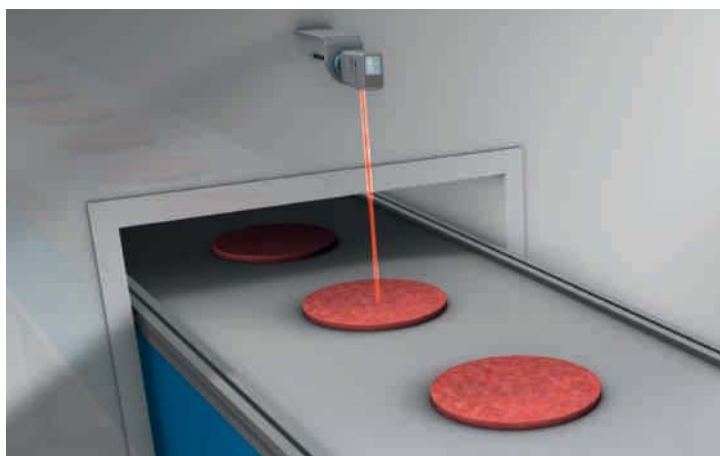

Diffuse sensors with background suppression

- Background suppression is used to detect the feed of objects into a packaging machine.



VeriSens[®] – the vision sensor for factory automation!

Baumer's image-processing *VeriSens* vision sensor bridges the gap between traditional photoelectric sensors and complex vision systems.

The high-resolution image sensor enables objects to be checked in a two-dimensional plane. For this purpose, the *VeriSens* vision sensor offers various functions, which support a large number of inspection and object detection tasks in an automated process.

- Completeness monitoring
- Object presence monitoring
- Object placement monitoring
- Object position monitoring

Discover the difference!

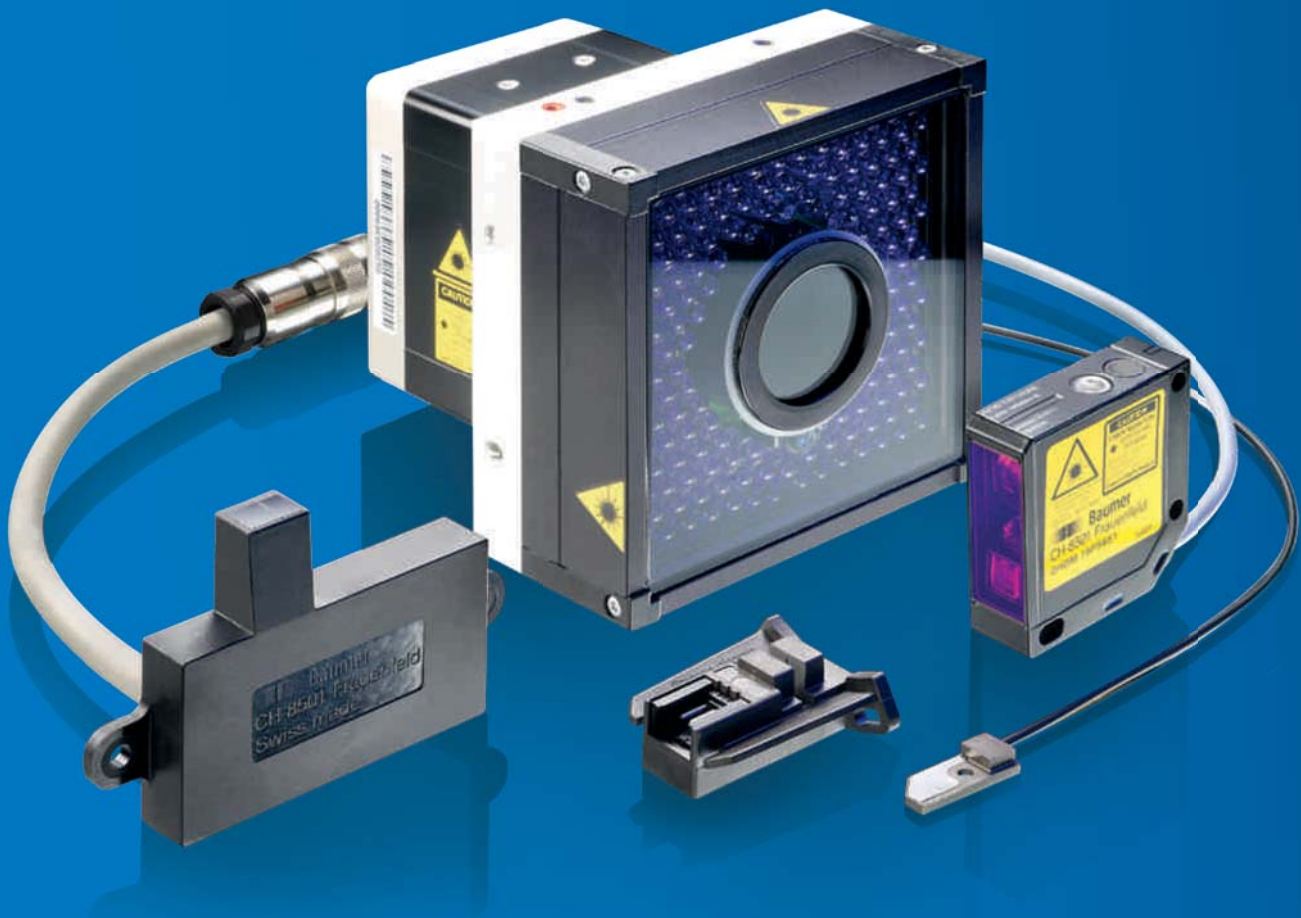

Custom designed photoelectric sensors

No product portfolio can ever be large enough to provide an optimum solution for every application. Needs always arise that cannot be handled with standard sensors. In such situations, our development engineers work closely with our customers to come up with a custom designed sensor that is the perfect solution.



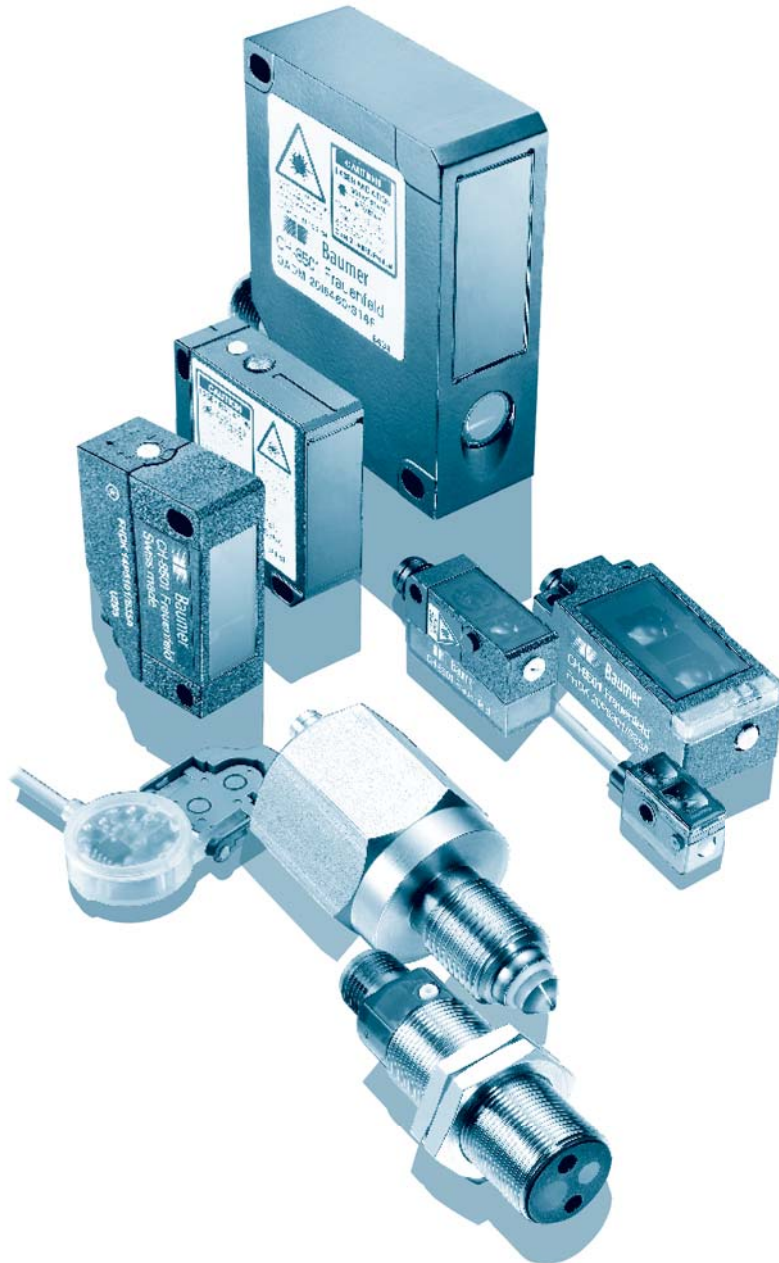

The solutions range from a special housing to a completely new sensor or optical system. An innovative, customized sensor solution can help you become a market leader.

We would be happy to help you with your application!

Distance and intensity-based











| | |
|--|----------|
| Distance measuring sensors | Page 20 |
| Difference sensors | Page 78 |
| Diffuse sensors with background suppression | Page 88 |
| Diffuse sensors with intensity difference | Page 144 |
| Level monitoring and leak detecting sensors | Page 184 |

| product family | FADH 14 | FADH 14 | FADK 14 | FADK 14 | FADR 14 |
|------------------------------|---|---|---|---|---|
| |  |  |  |  |  |
| width / diameter | 19,6 mm | 19,6 mm | 14,8 mm | 14,8 mm | 19,6 mm |
| measuring distance Sd | 50 ... 400 mm | 50 ... 400 mm | 50 ... 400 mm | 50 ... 400 mm | 50 ... 400 mm |
| resolution | 0,1 ... 1 mm | 0,1 ... 1 mm | 0,1 ... 1 mm | 0,1 ... 1 mm | 0,1 ... 1 mm |
| linearity error | ± 1,5 ... ± 4 mm | ± 1,5 ... ± 4 mm | ± 1,5 ... ± 4 mm | ± 1,5 ... ± 4 mm | ± 1,5 ... ± 4 mm |
| response time / release time | < 3 ms | < 3 ms | < 3 ms | < 3 ms | < 3 ms |
| adjustment | IO-Link | IO-Link | IO-Link | IO-Link | IO-Link |
| output circuit | analog | analog | analog | analog | analog |
| output signal | 4 ... 20 mA | 0 ... 10 VDC | 4 ... 20 mA | 0 ... 10 VDC | 4 ... 20 mA |
| connection types | cable flylead connector | cable flylead connector | cable connector | cable connector | connector |
| housing material | metal | metal | plastic | plastic | metal |
| page | 28 | 30 | 32 | 34 | 36 |

| product family | OADM 13 | OADM 13 | OADM 20 | OADM 20 | OADM 20 |
|------------------------------|---|---|--|---|---|
| |  |  |  |  |  |
| width / diameter | 13,4 mm | 13,4 mm | 20,6 mm | 20,6 mm | 20,6 mm |
| measuring distance Sd | 50 ... 60 mm 60 ... 100 mm 100 ... 200 mm | 50 ... 60 mm 60 ... 100 mm 100 ... 200 mm | 30 ... 70 mm 30 ... 130 mm | 50 ... 300 mm 100 ... 600 mm | 30 ... 70 mm 30 ... 130 mm 50 ... 300 mm |
| resolution | < 0,015 mm 0,015 ... 0,038 mm 0,039 ... 0,15 mm | < 0,015 mm 0,015 ... 0,038 mm 0,039 ... 0,15 mm | 0,004 ... 0,02 mm 0,005 ... 0,06 mm | 0,01 ... 0,33 mm 0,015 ... 0,67 mm | 0,004 ... 0,02 mm 0,005 ... 0,06 mm 0,01 ... 0,33 mm |
| linearity error | < 0,045 mm ± 0,047 ... ± 0,118 mm ± 0,123 ... ± 0,457 mm | < 0,045 mm ± 0,047 ... ± 0,118 mm ± 0,123 ... ± 0,457 mm | ± 0,012 ... ± 0,06 mm ± 0,015 ... ± 0,2 mm | ± 0,03 ... ± 1 mm ± 0,05 ... ± 2 mm | ± 0,012 ... ± 0,06 mm ± 0,015 ... ± 0,2 mm ± 0,03 ... ± 1 mm |
| response time / release time | < 2 ms | < 2 ms | < 0,9 ms | < 0,9 ms | < 0,9 ms |
| adjustment | Teach-in: button / external | Teach-in: button / external | Teach-in: button / external | Teach-in: button / external | Teach-in: button / external |
| output circuit | analog | analog | analog | analog | analog |
| output signal | 4 ... 20 mA | 0 ... 10 VDC | 4 ... 20 mA 0 ... 10 VDC | 4 ... 20 mA 0 ... 10 VDC | 4 ... 20 mA / 0 ... 10 VDC |
| connection types | connector | connector | connector | connector | connector |
| housing material | metal | metal | metal | metal | metal |
| page | 50 | 52 | 54 | 56 | 58 |

| FADR 14 | OADM 12 | OADM 13 | OADM 13 | OADM 13 | OADM 13 |
|---|---|---|---|---|---|
|  |  |  |  |  |  |
| 19,6 mm | 12,4 mm | 13,4 mm | 13,4 mm | 13,4 mm | 13,4 mm |
| 50 ... 400 mm | 16 ... 26 mm 16 ... 120 mm | 50 ... 350 mm 50 ... 550 mm | 50 ... 350 mm 50 ... 550 mm | 50 ... 350 mm 50 ... 550 mm | 50 ... 350 mm 50 ... 550 mm |
| 0,1 ... 1 mm | 0,002 ... 0,005 mm 0,002 ... 0,12 mm | 0,01 ... 0,4 mm 0,01 ... 1,15 mm | 0,01 ... 0,4 mm 0,01 ... 1,15 mm | 0,05 ... 0,4 mm 0,09 ... 1,15 mm | 0,05 ... 0,4 mm 0,09 ... 1,15 mm |
| ± 1,5 ... ± 4 mm | ± 0,006 ... ± 0,015 mm ± 0,015 ... ± 0,35 mm | ± 0,05 ... ± 1,2 mm ± 0,08 ... ± 3,5 mm | ± 0,05 ... ± 1,2 mm ± 0,08 ... ± 3,5 mm | ± 0,18 ... ± 1,2 mm ± 0,3 ... ± 3,5 mm | ± 0,18 ... ± 1,2 mm ± 0,3 ... ± 3,5 mm |
| < 3 ms | < 0,9 ms | < 0,9 ms < 2 ms | < 0,9 ms < 2 ms | < 0,9 ms < 2 ms | < 0,9 ms < 2 ms |
| IO-Link | Teach-in: button / external | Teach-in: button / external | Teach-in: button / external | no | no |
| analog | analog | analog | analog | RS 232 | RS 485 |
| 0 ... 10 VDC | 4 ... 20 mA 0 ... 10 VDC | 4 ... 20 mA | 0 ... 10 VDC | | |
| connector | connector | connector | connector | connector | connector |
| metal | metal | metal | metal | metal | metal |
| 38 | 40 | 42 | 44 | 46 | 48 |

| OADM 20 | OADM 20 | OADM 20 | OADM 20 | OADR 20 | OADM 21 |
|---|---|---|---|--|---|
|  |  |  |  |  |  |
| 20,6 mm | 20,6 mm | 20,6 mm | 20,6 mm | 20,3 mm | 20,4 mm |
| 100 ... 600 mm 200 ... 1000 mm | 30 ... 50 mm 30 ... 130 mm 50 ... 250 mm | 100 ... 500 mm 200 ... 1000 mm | 50 ... 300 mm 100 ... 600 mm 200 ... 1000 mm | 30 ... 130 mm 50 ... 300 mm 100 ... 600 mm | 100 ... 600 mm 200 ... 1000 mm |
| 0,015 ... 0,67 mm 0,12 ... 2,5 mm | < 0,01 mm 0,05 ... 0,07 mm 0,1 ... 0,3 mm | 0,2 ... 0,5 mm 0,6 ... 2,5 mm | 0,01 ... 0,4 mm 0,015 ... 0,8 mm 0,12 ... 3 mm | 0,005 ... 0,06 mm 0,01 ... 0,33 mm 0,015 ... 0,67 mm | 0,01 ... 0,25 mm 0,02 ... 0,4 mm |
| ± 0,05 ... ± 2 mm ± 0,48 ... ± 10 mm | ± 0,03 mm ± 0,15 ... ± 0,22 mm ± 0,3 ... ± 0,8 mm | ± 0,8 ... ± 2 mm ± 2,4 ... ± 10 mm | ± 0,2 ... ± 1,5 mm ± 0,5 ... ± 3,4 mm ± 0,36 ... ± 9 mm | ± 0,015 ... ± 0,2 mm ± 0,03 ... ± 1 mm ± 0,05 ... ± 2 mm | ± 0,07 ... ± 1 mm ± 0,11 ... ± 1,65 mm |
| < 0,9 ms | < 10 ms | < 10 ms | < 2 ms < 2,5 ms < 3,5 ms | < 0,9 ms | < 4 ms |
| Teach-in: button / external | no | no | Teach-in: button / external | external | Teach-in: button / external |
| analog | RS 485 | RS 485 | | analog | analog |
| 4 ... 20 mA/ 0 ... 10 VDC | | | 4 ... 20 mA/ 0 ... 10 VDC | 4 ... 20 mA/ 0 ... 10 VDC | 4 ... 20 mA/ 0 ... 10 VDC |
| connector | connector | connector | cable | connector | connector |
| metal | metal | metal | metal | metal | metal |
| 60 | 62 | 64 | 66 | 68 | 70 |

| product family | OADK 25 | OADM 250 | OADM 260 |
|------------------------------|---|---|--|
| |  |  |  |
| width / diameter | 23,4 mm | 25,4 mm | 25,4 mm |
| measuring distance Sd | 100 ... 1000 mm | 200 ... 4000 mm | 200 ... 13000 mm |
| resolution | 0,3 ... 4 mm | 1,3 mm | 5 mm |
| linearity error | ± 1,1 ... ± 15 mm | | |
| response time / release time | < 12,8 ms | | |
| adjustment | Teach-in | Teach-in: button / external | Teach-in: button / external |
| output circuit | analog | | |
| output signal | 4 ... 20 mA 0 ... 10 VDC | 4 ... 20 mA 0 ... 10 VDC | 4 ... 20 mA |
| connection types | connector | | |
| housing material | plastic | metal | metal |
| | | | |
| page | 72 | 74 | 76 |



General information

OADM is a range of laser distance sensors with products covering the measuring range from 16 mm to 13 m. The compact sensors with integrated microcontrollers produce an accurate output signal proportional to the measured distance. Intelligent internal signal analysis permits the sensor to operate accurately regardless of the color and most surfaces. The sensor can always be easily and precisely aligned with the visible spot of light. Distances to rough surfaces can be reliably measured by using a fine laser line in place of the laser spot, so that a wider area is monitored.

Typical applications

This family of sensors, with its wide selection of measuring ranges, can be used in many applications.

Typical applications are:

- Applications in which the production process is continuously monitored by the sensor to detect slow changes at an early stage and thereby achieve a reduction of rejects and costs.
- Automation of test points and test equipment permits increased productivity.
- Automation of format settings permits multifunctional machines and rapid, precise reconfiguration.

In some other applications, objects with rough and uneven surfaces must be measured. Sometimes, the surface of the object even has small holes or gaps. Such objects can be easily measured using a laser line optical system, which supplies a fine laser line in place of a focused laser beam.

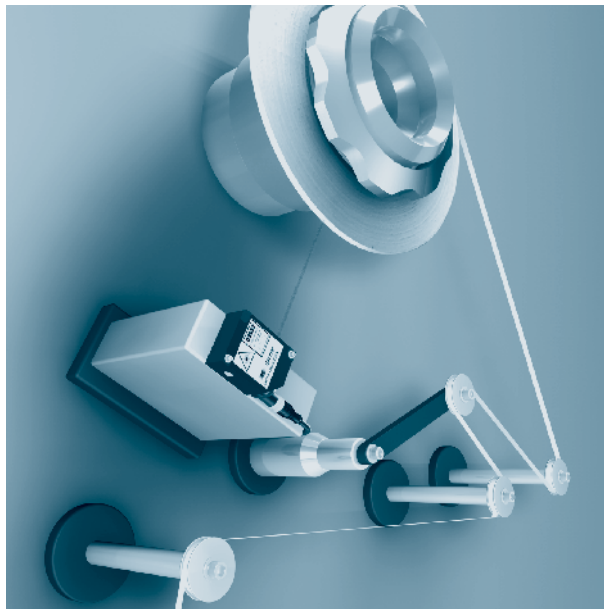



Characteristics and advantages

Response time

Measuring cycles as short as 0.9 ms permit accurate measurements even on moving parts.

Integrated microcontroller

The integrated microcontroller makes an external processing device unnecessary and makes it simple to place the sensor wherever it is needed.

High resolution and linearity

By the use of a photodiode line in triangulation sensors, a very high linearity of $\pm 6 \mu\text{m}$ is achieved at a resolution of up to $2 \mu\text{m}$ (measured on matte white ceramic).

Laser spot or laser line

Distances, even to rough surfaces, are reliably measured by using a laser line instead of the laser spot.

Any surface

Intelligent signal processing improves the measurements made on critical surfaces.

Teach-in function

The measuring range can be adjusted within the maximum measuring range by the user with the Teach-in button or via the Teach-in cable. The analog output has its full span within this taught-in range. The factory setting is the maximum measuring range. The taught-in range has a minimum extent. The resolution and linearity change when the measuring range is changed. The closer the furthest point of the measuring range is to the sensor, the better the resolution.

Synchronization/hold function

The measurements of several sensors can be synchronized using the sync input, or the last value can be held and the laser diode switched off.

Insensitivity to external light

An algorithm makes the sensor insensitive to external light sources.



Technology and operation

The distance measurement is based on the triangulation principle. The laser beam strikes the object as a small point. The receiver of the sensor (photodiode line) detects the position of this point. The angle of incidence changes according to the distance, and thereby the position of the laser point on the receiver. The photodiode line is read by an integrated microcontroller. The controller accurately calculates the angle from the light distribution on the photodiode line and then calculates the distance to the object from this. This distance is either issued at the serial port or converted into an output current proportional to the distance. The microcontroller guarantees a high degree of linearity and measuring precision. The combination of a photodiode line and a microcontroller permits interfering reflections to be suppressed and thereby provides reliable data from critical surfaces. The sensor adapts to different colors by adjusting its internal sensitivity, making it virtually independent of the color of the object. A digital output is activated if there is no object within the measuring range or if insufficient light is received to correctly detect the object, e.g. if the sensor is dirty. The possible resolution and accuracy change with the distance. The same distance Δd which causes a large change in the angle α_1 close to the sensor produces a much smaller change in the angle α_2 at a greater distance (see drawing). This non-linear behavior is corrected by the microcontroller, so that the output signal remains linear to the distance.

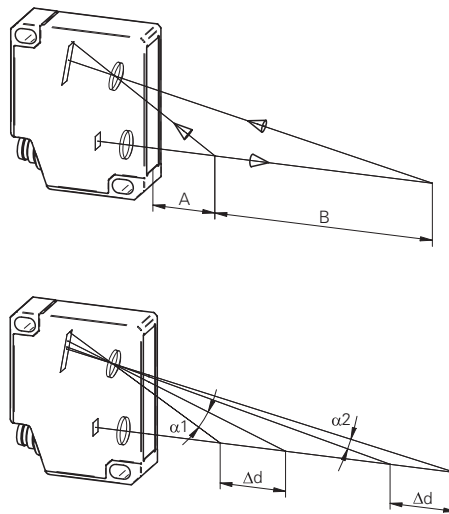

Technology and operation run time measurement

With the run time measurement method distances are measured indirectly by measuring the time required by a signal to travel the length of the range to be covered.

This translates into the real world as follows: a sender unit is emitting a burst signal which, when reflected by an object, is picked up by the sensor's receiver. The sensor's electronics evaluates the time elapsed and/or the phase-shift encountered which is then converted into distance information.

By applying the run time technology objects can be detected precisely and reliably even at long distances.



Mounting and adjustment

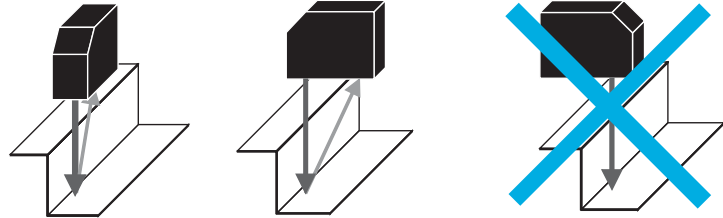

With all distance measuring sensors, it must be ensured that the laser spot can be seen directly by the optical system of the receiver and that no obstructions are in front of the receiver.



With glossy or reflective objects, the direct reflection must not impinge on the receiver. This can be avoided by slightly tilting the sensor.

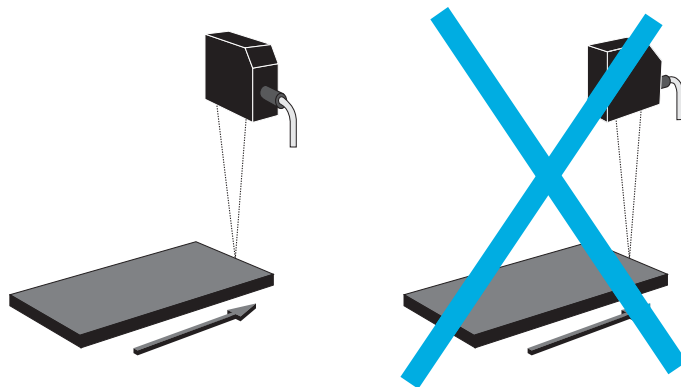

For optimum measurement results, the sensor must be installed at right angles to the movement of the object.

A simple rule applies for triangulation sensors that the distance between the sensor and the object should be kept as small as possible for each application. The shorter the range, the better (more than proportional) the resolution and accuracy.

Note on electromagnetic compatibility: ground the sensor and use a shielded connecting cable.

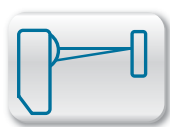

Sd = 50 ... 400 mm

- hygiene design
- compact design
- measuring distance Sd 50 ... 400 mm

general data

| | |
|------------------------|-------------------------|
| measuring distance Sd | 50 ... 400 mm |
| special type | Hygiene design |
| adjustment | IO-Link |
| Teach-in range min. | > 20 mm |
| power on indication | LED green |
| soiled lens indicator | LED red |
| resolution | 0,1 ... 1 mm |
| linearity error | ± 1,5 ... ± 4 mm |
| light source | pulsed point source LED |
| wave length | 660 nm |
| beam type | point |
| beam diameter | 8 mm |
| temperature drift | < 0,1 % Sde/K |
| approvals/certificates | Ecolab EHEDG |

electrical data

| | |
|------------------------------------|-------------------------|
| response time / release time | < 3 ms |
| voltage supply range +Vs | 12 ... 26 VDC |
| current consumption max. (no load) | 80 mA |
| output circuit | analog |
| output signal | 4 ... 20 mA |
| load resistance (analog I) | < (+Vs - 10 V) / 0,02 A |
| output current | < 100 mA |
| alarm output | push-pull |
| short circuit protection | yes |
| reverse polarity protection | yes, Vs to GND |

mechanical data

| | |
|------------------|-----------------------------------|
| width / diameter | 19,6 mm |
| height / length | 52,2 mm |
| depth | 34,3 mm |
| type | rectangular |
| housing material | stainless steel 1.4404 (V4A); LSR |
| front (optics) | PMMA |

ambient conditions

| | |
|-----------------------|----------------------|
| operating temperature | 0 ... +50 °C |
| protection class | IP 68/69K & proTect+ |

order reference

| order reference | connection types |
|-----------------------|---------------------------------|
| FADH 14I4470/IO | cable 4 pin, 2 m |
| FADH 14I4470/KS34A/IO | flylead connector M12, L=300 mm |



connection diagram

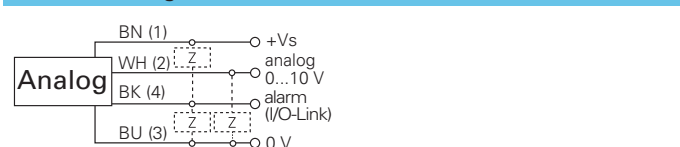

connectors

| | | |
|---------------|-------|-------------------------|
| ESG 32AP0200G | 4 pin | 2 m straight (shielded) |
| ESG 32AP0500G | 4 pin | 5 m straight (shielded) |
| ESW 31AP0500G | 4 pin | 5 m angular (shielded) |

additional cable connectors and field wireable connectors, see accessories

accessories

| | | |
|----------|---------|---------|
| mounting | ø 17 mm | HI17-1H |
|----------|---------|---------|

for details, see accessories section

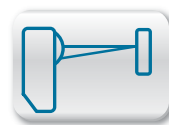

resolution

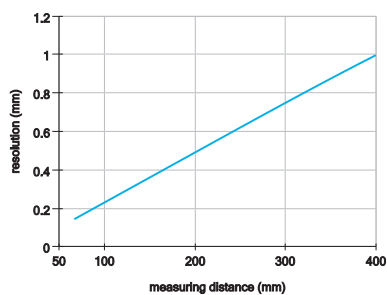

linearity error

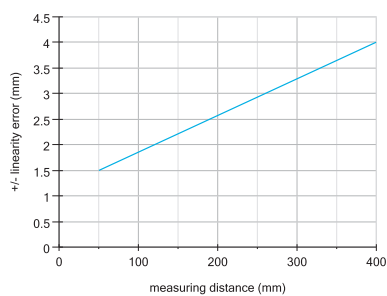

dimension drawing

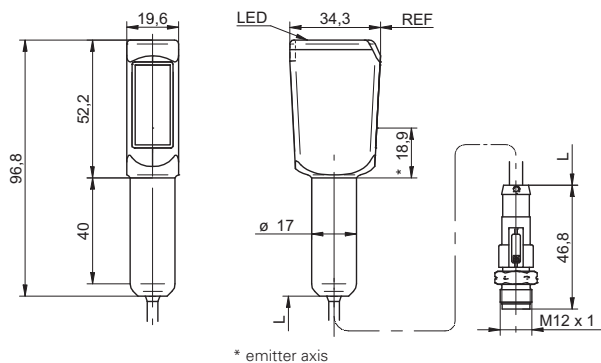
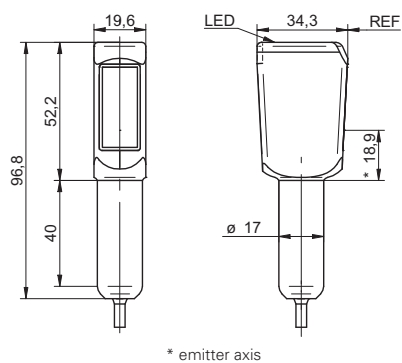

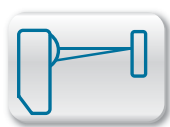

Sd = 50 ... 400 mm

- hygiene design
- compact design
- measuring distance Sd 50 ... 400 mm

general data

| | |
|------------------------|-------------------------|
| measuring distance Sd | 50 ... 400 mm |
| special type | Hygiene design |
| adjustment | IO-Link |
| Teach-in range min. | > 20 mm |
| power on indication | LED green |
| soiled lens indicator | LED red |
| resolution | 0,1 ... 1 mm |
| linearity error | ± 1,5 ... ± 4 mm |
| light source | pulsed point source LED |
| wave length | 660 nm |
| beam type | point |
| beam diameter | 8 mm |
| temperature drift | < 0,1 % Sde/K |
| approvals/certificates | Ecolab EHEDG |

electrical data

| | |
|------------------------------------|----------------|
| response time / release time | < 3 ms |
| voltage supply range +Vs | 14 ... 26 VDC |
| current consumption max. (no load) | 80 mA |
| output circuit | analog |
| output signal | 0 ... 10 VDC |
| load resistance (analog U) | > 100 kOhm |
| output current | < 100 mA |
| alarm output | push-pull |
| short circuit protection | yes |
| reverse polarity protection | yes, Vs to GND |

mechanical data

| | |
|------------------|-----------------------------------|
| width / diameter | 19,6 mm |
| height / length | 52,2 mm |
| depth | 34,3 mm |
| type | rectangular |
| housing material | stainless steel 1.4404 (V4A); LSR |
| front (optics) | PMMA |

ambient conditions

| | |
|-----------------------|----------------------|
| operating temperature | 0 ... +50 °C |
| protection class | IP 68/69K & proTect+ |

order reference

| order reference | connection types |
|-----------------------|---------------------------------|
| FADH 14U4470/IO | cable 4 pin, 2 m |
| FADH 14U4470/KS34A/IO | flylead connector M12, L=300 mm |



connection diagram

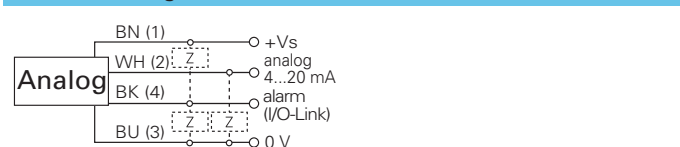

connectors

| | | |
|---------------|-------|-------------------------|
| ESG 32AP0200G | 4 pin | 2 m straight (shielded) |
| ESG 32AP0500G | 4 pin | 5 m straight (shielded) |
| ESW 31AP0500G | 4 pin | 5 m angular (shielded) |

additional cable connectors and field wireable connectors, see accessories

accessories

| | | |
|----------|---------|---------|
| mounting | ø 17 mm | HI17-1H |
|----------|---------|---------|

for details, see accessories section

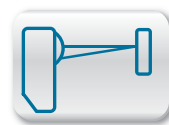

resolution

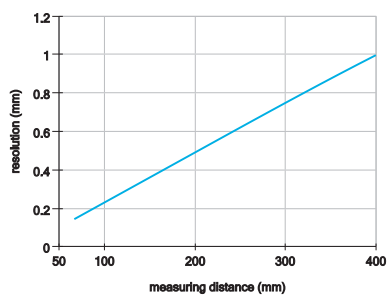

linearity error

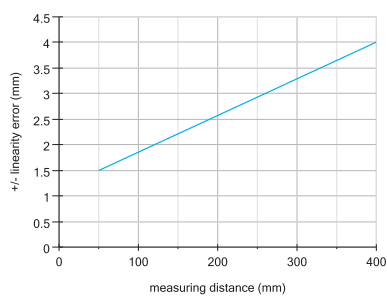

dimension drawing

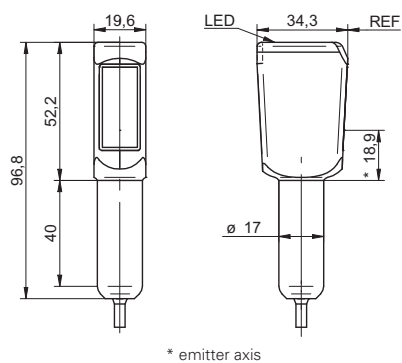

* emitter axis

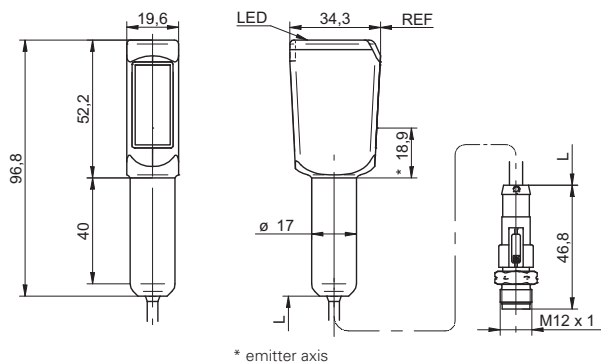

* emitter axis

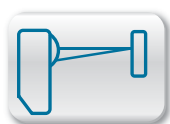

Sd = 50 ... 400 mm

- compact design
- measuring distance Sd 50 ... 400 mm
- resolution up to 0,1 mm



general data

| | |
|-----------------------|-------------------------|
| measuring distance Sd | 50 ... 400 mm |
| adjustment | IO-Link |
| Teach-in range min. | > 20 mm |
| power on indication | LED green |
| soiled lens indicator | LED red |
| resolution | 0,1 ... 1 mm |
| linearity error | ± 1,5 ... ± 4 mm |
| light source | pulsed point source LED |
| wave length | 660 nm |
| beam type | point |
| beam diameter | 8 mm |
| temperature drift | < 0,1 % Sde/K |

electrical data

| | |
|------------------------------------|-------------------------|
| response time / release time | < 3 ms |
| voltage supply range +Vs | 12 ... 26 VDC |
| current consumption max. (no load) | 80 mA |
| output circuit | analog |
| output signal | 4 ... 20 mA |
| load resistance (analog I) | < (+Vs - 10 V) / 0,02 A |
| output current | < 100 mA |
| alarm output | push-pull |
| short circuit protection | yes |
| reverse polarity protection | yes, Vs to GND |

mechanical data

| | |
|------------------|---------------------|
| width / diameter | 14,8 mm |
| height / length | 43 mm |
| depth | 31 mm |
| type | rectangular |
| housing material | plastic (ASA, MABS) |
| front (optics) | PMMA |

ambient conditions

| | |
|-----------------------|--------------|
| operating temperature | 0 ... +50 °C |
| protection class | IP 67 |

order reference

| order reference | connection types |
|----------------------|---------------------|
| FADK 14I4470/IO | cable 4 pin, 2 m |
| FADK 14I4470/S14/IO | connector M12 4 pin |
| FADK 14I4470/S35A/IO | connector M8 4 pin |

connection diagram

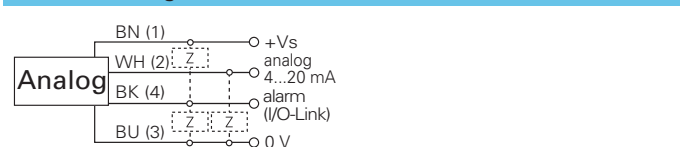

connectors

| | | |
|---------------|-------|-------------------------|
| ESG 32AP0200G | 4 pin | 2 m straight (shielded) |
| ESG 32AP0500G | 4 pin | 5 m straight (shielded) |
| ESW 31AP0500G | 4 pin | 5 m angular (shielded) |

additional cable connectors and field wireable connectors, see accessories

accessories

| | |
|-----------------------|----------|
| SENSOFIX mounting kit | 10149011 |
| mounting bracket | 10134964 |

for details, see accessories section

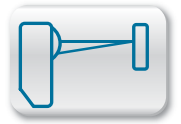

resolution

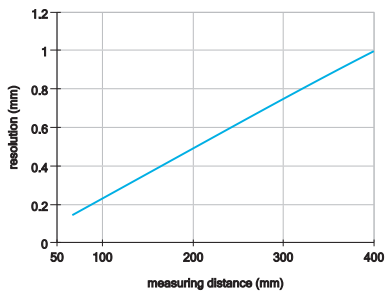

linearity error

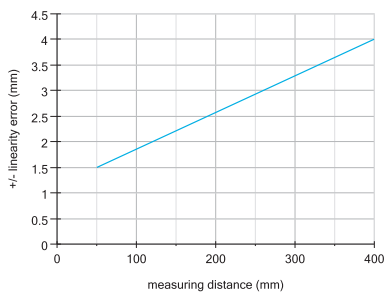

dimension drawing

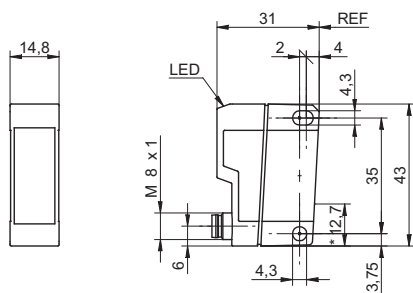

* emitter axis

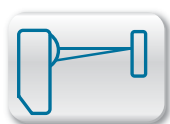

Sd = 50 ... 400 mm

- compact design
- measuring distance Sd 50 ... 400 mm
- resolution up to 0,1 mm



general data

| | |
|-----------------------|-------------------------|
| measuring distance Sd | 50 ... 400 mm |
| adjustment | IO-Link |
| Teach-in range min. | > 20 mm |
| power on indication | LED green |
| soiled lens indicator | LED red |
| resolution | 0,1 ... 1 mm |
| linearity error | ± 1,5 ... ± 4 mm |
| light source | pulsed point source LED |
| wave length | 660 nm |
| beam type | point |
| beam diameter | 8 mm |
| temperature drift | < 0,1 % Sde/K |

electrical data

| | |
|------------------------------------|----------------|
| response time / release time | < 3 ms |
| voltage supply range +Vs | 14 ... 26 VDC |
| current consumption max. (no load) | 80 mA |
| output circuit | analog |
| output signal | 0 ... 10 VDC |
| load resistance (analog U) | > 100 kOhm |
| output current | < 100 mA |
| alarm output | push-pull |
| short circuit protection | yes |
| reverse polarity protection | yes, Vs to GND |

mechanical data

| | |
|------------------|---------------------|
| width / diameter | 14,8 mm |
| height / length | 43 mm |
| depth | 31 mm |
| type | rectangular |
| housing material | plastic (ASA, MABS) |
| front (optics) | PMMA |

ambient conditions

| | |
|-----------------------|--------------|
| operating temperature | 0 ... +50 °C |
| protection class | IP 67 |

order reference

| order reference | connection types |
|----------------------|---------------------|
| FADK 14U4470/IO | cable 4 pin, 2 m |
| FADK 14U4470/S14/IO | connector M12 4 pin |
| FADK 14U4470/S35A/IO | connector M8 4 pin |

connection diagram

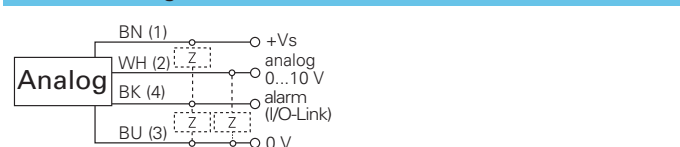

connectors

| | | |
|---------------|-------|-------------------------|
| ESG 32AP0200G | 4 pin | 2 m straight (shielded) |
| ESG 32AP0500G | 4 pin | 5 m straight (shielded) |
| ESW 31AP0500G | 4 pin | 5 m angular (shielded) |

additional cable connectors and field wireable connectors, see accessories

accessories

| | |
|-----------------------|----------|
| SENSOFIX mounting kit | 10149011 |
| mounting bracket | 10134964 |

for details, see accessories section

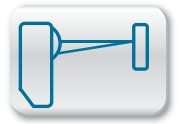

resolution

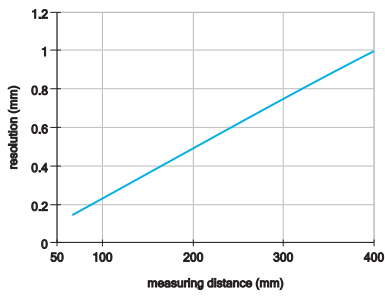

linearity error

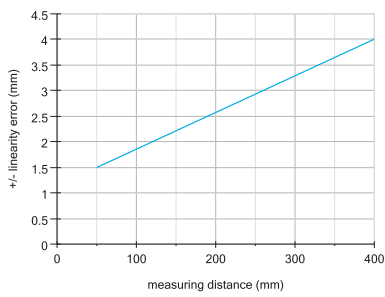

dimension drawing

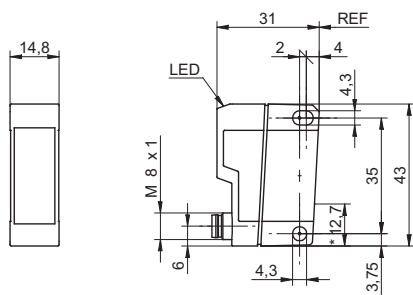

* emitter axis

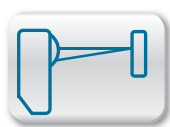
Sd = 50 ... 400 mm

- washdown design
- compact design
- measuring distance Sd 50 ... 400 mm

general data

| | |
|------------------------|-------------------------|
| measuring distance Sd | 50 ... 400 mm |
| special type | Washdown design |
| adjustment | IO-Link |
| Teach-in range min. | > 20 mm |
| power on indication | LED green |
| soiled lens indicator | LED red |
| resolution | 0,1 ... 1 mm |
| linearity error | ± 1,5 ... ± 4 mm |
| light source | pulsed point source LED |
| wave length | 660 nm |
| beam type | point |
| beam diameter | 8 mm |
| temperature drift | < 0,1 % Sde/K |
| approvals/certificates | Ecolab |

electrical data

| | |
|------------------------------------|-------------------------|
| response time / release time | < 3 ms |
| voltage supply range +Vs | 12 ... 26 VDC |
| current consumption max. (no load) | 80 mA |
| output circuit | analog |
| output signal | 4 ... 20 mA |
| load resistance (analog I) | < (+Vs - 10 V) / 0,02 A |
| output current | < 100 mA |
| alarm output | push-pull |
| short circuit protection | yes |
| reverse polarity protection | yes, Vs to GND |

mechanical data

| | |
|------------------|-----------------------------------|
| width / diameter | 19,6 mm |
| height / length | 51 mm |
| depth | 34,3 mm |
| type | rectangular |
| housing material | stainless steel 1.4404 (V4A); LSR |
| front (optics) | PMMA |
| connection types | connector M12 |

ambient conditions

| | |
|-----------------------|----------------------|
| operating temperature | 0 ... +50 °C |
| protection class | IP 68/69K & proTect+ |

order reference
FADR 14I4470/S14/IO

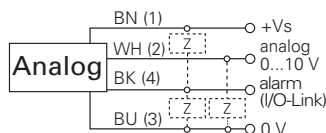
connection diagram

connectors

| | | |
|---------------|-------|-------------------------|
| ESG 32AP0200G | 4 pin | 2 m straight (shielded) |
| ESG 32AP0500G | 4 pin | 5 m straight (shielded) |
| ESW 31AP0500G | 4 pin | 5 m angular (shielded) |

additional cable connectors and field wireable connectors, see accessories

accessories

| | |
|-----------------------|----------|
| SENSOFIX mounting kit | 11046279 |
| mounting bracket | 11046278 |

for details, see accessories section

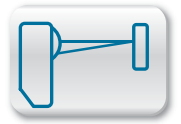

resolution

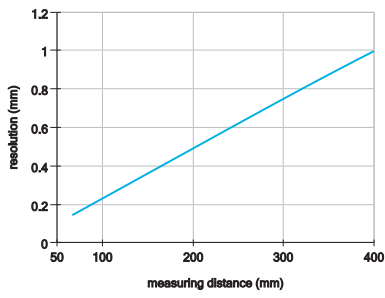

linearity error

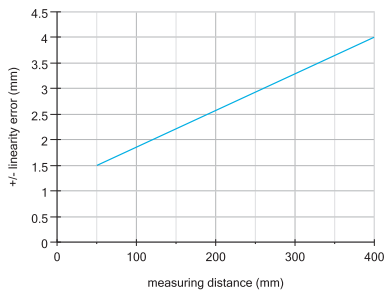

dimension drawing

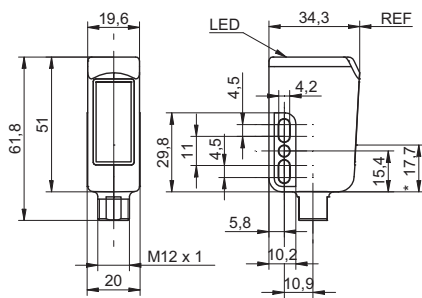

* emitter axis

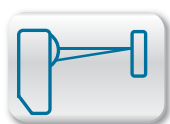
Sd = 50 ... 400 mm

- washdown design
- compact design
- measuring distance Sd 50 ... 400 mm

general data

| | |
|------------------------|-------------------------|
| measuring distance Sd | 50 ... 400 mm |
| special type | Washdown design |
| adjustment | IO-Link |
| Teach-in range min. | > 20 mm |
| power on indication | LED green |
| soiled lens indicator | LED red |
| resolution | 0,1 ... 1 mm |
| linearity error | ± 1,5 ... ± 4 mm |
| light source | pulsed point source LED |
| wave length | 660 nm |
| beam type | point |
| beam diameter | 8 mm |
| temperature drift | < 0,1 % Sde/K |
| approvals/certificates | Ecolab |

electrical data

| | |
|------------------------------------|----------------|
| response time / release time | < 3 ms |
| voltage supply range +Vs | 14 ... 26 VDC |
| current consumption max. (no load) | 80 mA |
| output circuit | analog |
| output signal | 0 ... 10 VDC |
| load resistance (analog U) | > 100 kOhm |
| output current | < 100 mA |
| alarm output | push-pull |
| short circuit protection | yes |
| reverse polarity protection | yes, Vs to GND |

mechanical data

| | |
|------------------|-----------------------------------|
| width / diameter | 19,6 mm |
| height / length | 51 mm |
| depth | 34,3 mm |
| type | rectangular |
| housing material | stainless steel 1.4404 (V4A); LSR |
| front (optics) | PMMA |
| connection types | connector M12 |

ambient conditions

| | |
|-----------------------|----------------------|
| operating temperature | 0 ... +50 °C |
| protection class | IP 68/69K & proTect+ |

order reference
FADR 14U4470/S14/IO

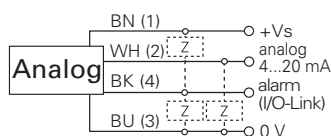
connection diagram

connectors

| | | |
|---------------|-------|-------------------------|
| ESG 32AP0200G | 4 pin | 2 m straight (shielded) |
| ESG 32AP0500G | 4 pin | 5 m straight (shielded) |
| ESW 31AP0500G | 4 pin | 5 m angular (shielded) |

additional cable connectors and field wireable connectors, see accessories

accessories

| | |
|-----------------------|----------|
| SENSOFIX mounting kit | 11046279 |
| mounting bracket | 11046278 |

for details, see accessories section

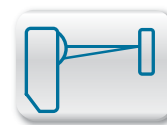

resolution

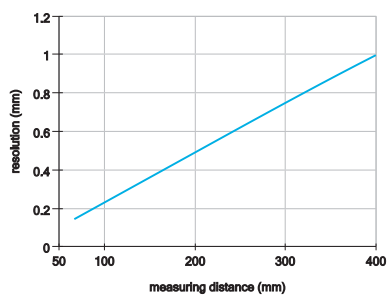

linearity error

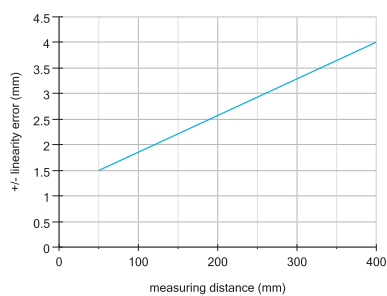

dimension drawing

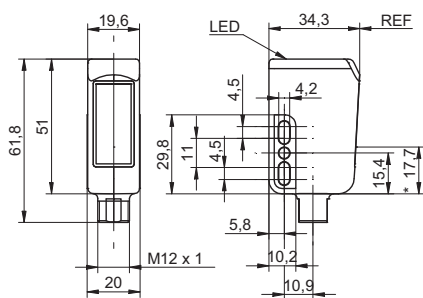

* emitter axis

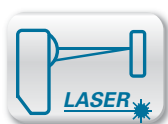

Sd = 16 ... 120 mm



- smallest distance measuring sensor
- teachable measuring range $S_r > 1$ mm
- resolution up to 2 μ m

general data

| | |
|--------------------------|-----------------------------|
| adjustment | Teach-in: button / external |
| power on indication | LED green |
| soiled lens indicator | LED red |
| light source | pulsed red laser diode |
| wave length | 650 nm |
| laser class | 2 |
| beam type | point |
| interference suppression | < 30 ms |

measuring distance Sd = 16 ... 26 mm

| | |
|---------------------|--------------------------------|
| Teach-in range min. | > 1 mm |
| resolution | 0,002 ... 0,005 mm |
| linearity error | $\pm 0,006$... $\pm 0,015$ mm |
| beam diameter | 0,5 ... 0,2 mm |
| temperature drift | < 0,04 % Sde/K |

measuring distance Sd = 16 ... 120 mm

| | |
|---------------------|-------------------------------|
| Teach-in range min. | > 2 mm |
| resolution | 0,002 ... 0,12 mm |
| linearity error | $\pm 0,015$... $\pm 0,35$ mm |
| beam diameter | 0,9 ... 0,5 mm |
| temperature drift | < 0,06 % Sde/K |

electrical data

| | |
|------------------------------------|----------------|
| response time / release time | < 0,9 ms |
| voltage supply range +Vs | 12 ... 28 VDC |
| current consumption max. (no load) | 100 mA |
| output circuit | analog |
| short circuit protection | yes |
| reverse polarity protection | yes, Vs to GND |

mechanical data

| | |
|------------------|--------------------|
| width / diameter | 12,4 mm |
| height / length | 37 mm |
| depth | 34,5 mm |
| type | rectangular |
| housing material | die-cast zinc |
| front (optics) | glass |
| connection types | connector M8 4 pin |

ambient conditions

| | |
|-----------------------|--------------|
| operating temperature | 0 ... +50 °C |
| protection class | IP 67 |

connection diagrams

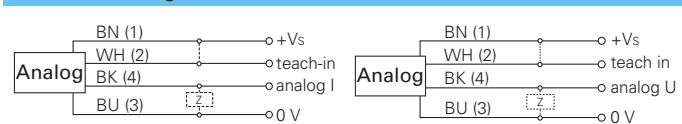

connectors

| | | |
|---------------|-------|-------------------------|
| ESG 32AP0200G | 4 pin | 2 m straight (shielded) |
| ESG 32AP0500G | 4 pin | 5 m straight (shielded) |
| ESW 31AP0500G | 4 pin | 5 m angular (shielded) |

additional cable connectors and field wireable connectors, see accessories

accessories

| | |
|-----------------------|----------|
| SENSOFIX mounting kit | 10150328 |
| mounting bracket | 10113873 |

for details, see accessories section

remarks

For objects with a reflectivity < 4 %, the response time / release time is increased automatically up to max. 1,5 ms.
 Missed measurement up to 30 cycles (30 ms) will be suppressed.
 During this time the analog output stays on hold.

laser warning



Complies with 21 CFR 1040.10 and 1040.11 except for deviations pursuant to laser notice No. 50, dated June 24, 2007

| order reference | measuring distance Sd | output signal | load resistance | ambient light immunity |
|-------------------|-----------------------|---------------|------------------------|------------------------|
| OADM 12I6430/S35A | 16 ... 26 mm | 4 ... 20 mA | < (+Vs - 6 V) / 0,02 A | < 100 kLux |
| OADM 12I6460/S35A | 16 ... 120 mm | 4 ... 20 mA | < (+Vs - 6 V) / 0,02 A | < 30 kLux |
| OADM 12U6430/S35A | 16 ... 26 mm | 0 ... 10 VDC | > 100 kOhm | < 100 kLux |
| OADM 12U6460/S35A | 16 ... 120 mm | 0 ... 10 VDC | > 100 kOhm | < 30 kLux |

Photoelectric distance measuring sensors OADM 12 Sd = 16 ... 120 mm

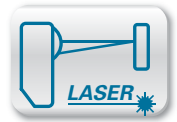

resolution

Sd = 16 ... 26 mm

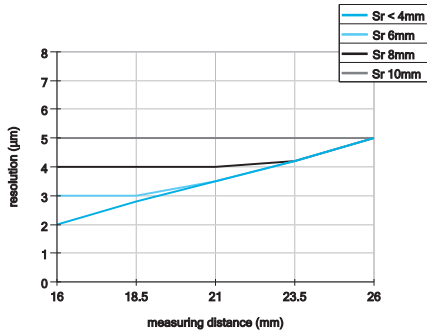

Sd = 16 ... 120 mm

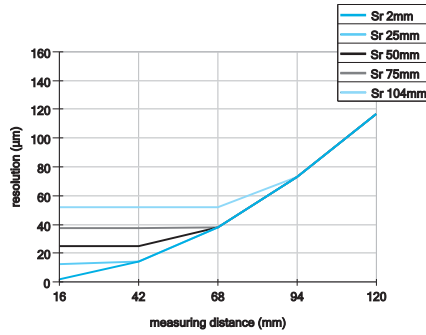

linearity errors

Sd = 16 ... 26 mm

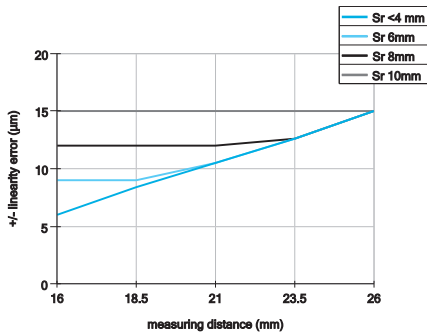

Sd = 16 ... 120 mm

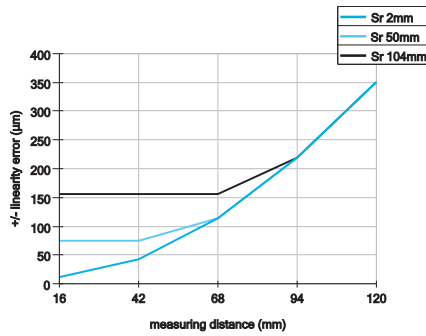

dimension drawing

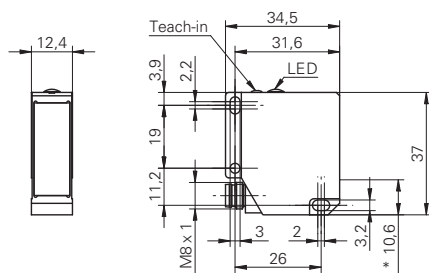

* emitter axis

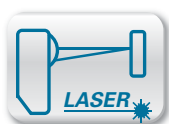

Sd = 50 ... 550 mm



- compact housing, current output
- teachable measuring range $S_r > 5$ mm
- resolution up to 10 μ m

general data

| | |
|--------------------------|-----------------------------|
| adjustment | Teach-in: button / external |
| power on indication | LED green |
| soiled lens indicator | LED red |
| light source | pulsed red laser diode |
| wave length | 650 nm |
| laser class | 2 |
| interference suppression | < 30 ms |

measuring distance Sd = 50 ... 350 mm

| | |
|---------------------|-----------------------------|
| Teach-in range min. | > 5 mm |
| resolution | 0,01 ... 0,4 mm |
| linearity error | $\pm 0,05$... $\pm 1,2$ mm |
| temperature drift | < 0,04 % Sde/K |

measuring distance Sd = 50 ... 550 mm

| | |
|---------------------|-----------------------------|
| Teach-in range min. | > 10 mm |
| resolution | 0,01 ... 1,15 mm |
| linearity error | $\pm 0,08$... $\pm 3,5$ mm |
| temperature drift | < 0,07 % Sde/K |

electrical data

| | |
|------------------------------------|--------------------------|
| voltage supply range +Vs | 12 ... 28 VDC |
| current consumption max. (no load) | 100 mA |
| output circuit | analog |
| output signal | 4 ... 20 mA |
| load resistance | < $(+Vs - 6 V) / 0,02 A$ |
| short circuit protection | yes |
| reverse polarity protection | yes, Vs to GND |

mechanical data

| | |
|------------------|--------------------|
| width / diameter | 13,4 mm |
| height / length | 48,2 mm |
| depth | 40 mm |
| type | rectangular |
| housing material | aluminum |
| front (optics) | glass |
| connection types | connector M8 4 pin |

ambient conditions

| | |
|-----------------------|--------------|
| operating temperature | 0 ... +50 °C |
| protection class | IP 67 |

connection diagram

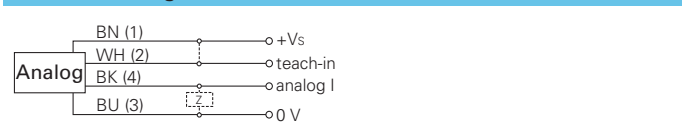

connectors

| | | |
|---------------|-------|-------------------------|
| ESG 32AP0200G | 4 pin | 2 m straight (shielded) |
| ESG 32AP0500G | 4 pin | 5 m straight (shielded) |
| ESW 31AP0500G | 4 pin | 5 m angular (shielded) |

additional cable connectors and field wireable connectors, see accessories

accessories

| | |
|-----------------------|----------|
| SENSOFIX mounting kit | 10161829 |
| mounting bracket | 10161695 |

for details, see accessories section

remarks

For objects with a reflectivity < 6 %, the response time / release time is increased automatically up to max. 3 ms (OADM 13x6x75/S35A) resp. 5 ms (OADM 13x7x80/S35A). Missed measurement up to 30 cycles (30 ms) will be suppressed. During this time the analog output stays on hold.

laser warning



Complies with 21 CFR 1040.10 and 1040.11 except for deviations pursuant to laser notice No. 50, dated June 24, 2007

| order reference | measuring distance Sd | response time / release time | beam type | beam width | beam height | beam diameter | ambient light immunity |
|-------------------|-----------------------|------------------------------|-----------|------------|-------------|---------------|------------------------|
| OADM 13I6475/S35A | 50 ... 350 mm | < 0,9 ms | point | - | - | 1 mm | < 20 kLux |
| OADM 13I6575/S35A | 50 ... 350 mm | < 0,9 ms | line | 2 mm | 4 ... 9 mm | - | < 30 kLux |
| OADM 13I7480/S35A | 50 ... 550 mm | < 2 ms | point | - | - | 1 mm | < 40 kLux |
| OADM 13I7580/S35A | 50 ... 550 mm | < 2 ms | line | 2 ... 1 mm | 4 ... 11 mm | - | < 40 kLux |

Photoelectric distance measuring sensors OADM 13 Sd = 50 ... 550 mm

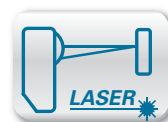

resolution

Sd = 50 ... 350 mm

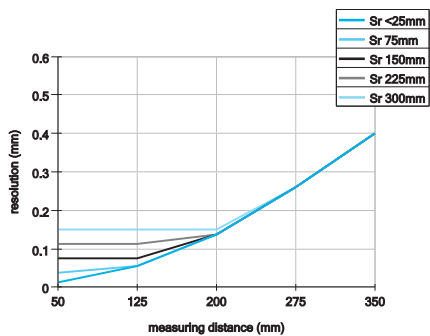

Sd = 50 ... 550 mm

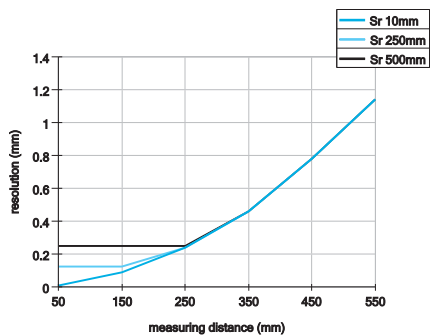

linearity errors

Sd = 50 ... 350 mm

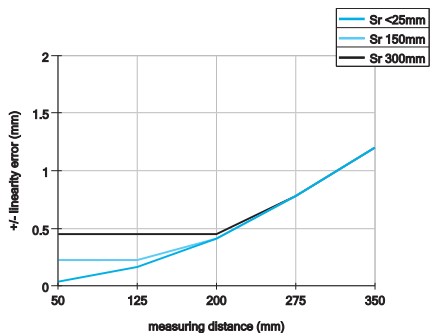

Sd = 50 ... 550 mm

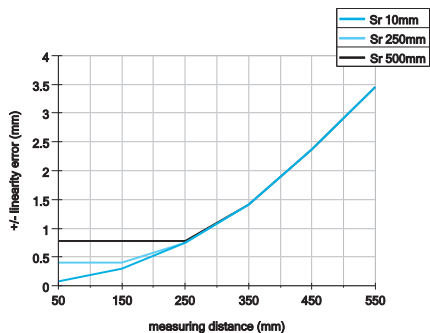

beam alignment (line)

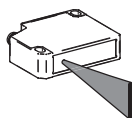

dimension drawing

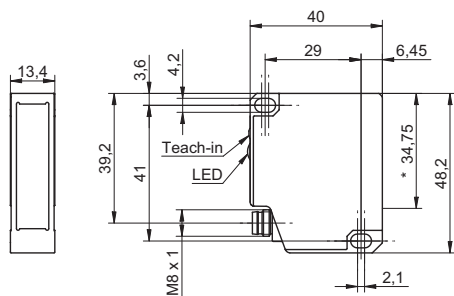

* emitter axis

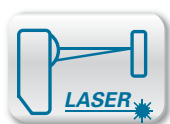

Sd = 50 ... 550 mm



- compact housing, voltage output
- teachable measuring range $S_r > 5$ mm
- resolution up to 10 μ m

general data

| | |
|--------------------------|-----------------------------|
| adjustment | Teach-in: button / external |
| power on indication | LED green |
| soiled lens indicator | LED red |
| light source | pulsed red laser diode |
| wave length | 650 nm |
| laser class | 2 |
| interference suppression | < 30 ms |

measuring distance Sd = 50 ... 350 mm

| | |
|---------------------|-----------------------------|
| Teach-in range min. | > 5 mm |
| resolution | 0,01 ... 0,4 mm |
| linearity error | $\pm 0,05$... $\pm 1,2$ mm |
| temperature drift | < 0,04 % Sde/K |

measuring distance Sd = 50 ... 550 mm

| | |
|---------------------|-----------------------------|
| Teach-in range min. | > 10 mm |
| resolution | 0,01 ... 1,15 mm |
| linearity error | $\pm 0,08$... $\pm 3,5$ mm |
| temperature drift | < 0,07 % Sde/K |

electrical data

| | |
|------------------------------------|----------------|
| voltage supply range +Vs | 12 ... 28 VDC |
| current consumption max. (no load) | 80 mA |
| output circuit | analog |
| output signal | 0 ... 10 VDC |
| load resistance | > 100 kOhm |
| short circuit protection | yes |
| reverse polarity protection | yes, Vs to GND |

mechanical data

| | |
|------------------|--------------------|
| width / diameter | 13,4 mm |
| height / length | 48,2 mm |
| depth | 40 mm |
| type | rectangular |
| housing material | aluminum |
| front (optics) | glass |
| connection types | connector M8 4 pin |

ambient conditions

| | |
|-----------------------|--------------|
| operating temperature | 0 ... +50 °C |
| protection class | IP 67 |

connection diagram

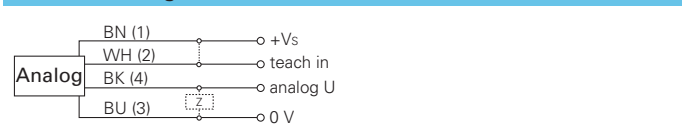

connectors

| | | |
|---------------|-------|-------------------------|
| ESG 32AP0200G | 4 pin | 2 m straight (shielded) |
| ESG 32AP0500G | 4 pin | 5 m straight (shielded) |
| ESW 31AP0500G | 4 pin | 5 m angular (shielded) |

additional cable connectors and field wireable connectors, see accessories

accessories

| | |
|-----------------------|----------|
| SENSOFIX mounting kit | 10161829 |
| mounting bracket | 10161695 |

for details, see accessories section

remarks

For objects with a reflectivity < 6 %, the response time / release time is increased automatically up to max. 3 ms (OADM 13x6x75/S35A) resp. 5 ms (OADM 13x7x80/S35A). Missed measurement up to 30 cycles (30 ms) will be suppressed. During this time the analog output stays on hold.

laser warning



Complies with 21 CFR 1040.10 and 1040.11 except for deviations pursuant to laser notice No. 50, dated June 24, 2007

| order reference | measuring distance Sd | response time / release time | beam type | beam width | beam height | beam diameter | ambient light immunity |
|-------------------|-----------------------|------------------------------|-----------|------------|-------------|---------------|------------------------|
| OADM 13U6475/S35A | 50 ... 350 mm | < 0,9 ms | point | - | - | 1 mm | < 20 kLux |
| OADM 13U6575/S35A | 50 ... 350 mm | < 0,9 ms | line | 2 mm | 4 ... 9 mm | - | < 30 kLux |
| OADM 13U7480/S35A | 50 ... 550 mm | < 2 ms | point | - | - | 1 mm | < 40 kLux |
| OADM 13U7580/S35A | 50 ... 550 mm | < 2 ms | line | 2 ... 1 mm | 4 ... 11 mm | - | < 40 kLux |

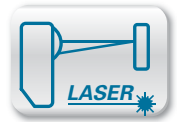

resolution

Sd = 50 ... 350 mm

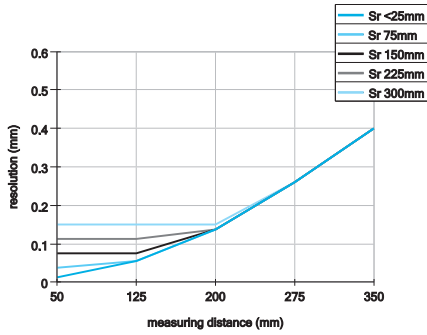

Sd = 50 ... 550 mm

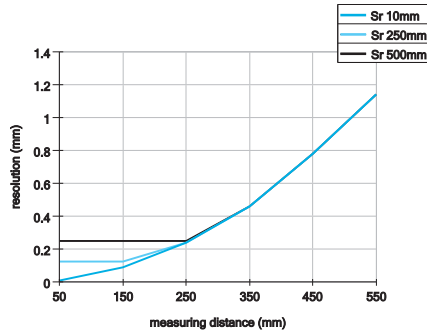

linearity errors

Sd = 50 ... 350 mm

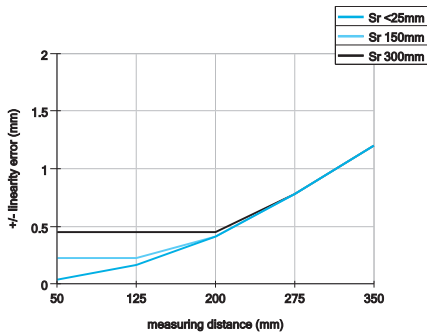

Sd = 50 ... 550 mm

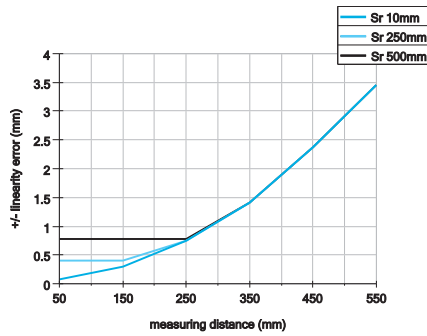

beam alignment (line)

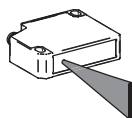

dimension drawing

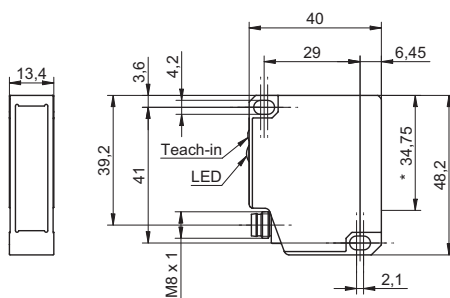

* emitter axis

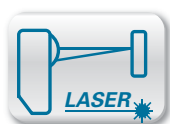

Sd = 50 ... 550 mm

- serial interface RS 232
- resolution up to 50 µm
- also with laser line for rough surfaces



general data

| | |
|---------------------|------------------------|
| adjustment | no |
| power on indication | LED green |
| light source | pulsed red laser diode |
| wave length | 650 nm |
| laser class | 2 |
| alarm indicator | LED red |

measuring distance Sd = 50 ... 350 mm

| | |
|-------------------|---------------------|
| resolution | 0,05 ... 0,4 mm |
| linearity error | ± 0,18 ... ± 1,2 mm |
| temperature drift | < 0,04 % Sde/K |

measuring distance Sd = 50 ... 550 mm

| | |
|-------------------|--------------------|
| resolution | 0,09 ... 1,15 mm |
| linearity error | ± 0,3 ... ± 3,5 mm |
| temperature drift | < 0,07 % Sde/K |

electrical data

| | |
|------------------------------------|-------------------|
| voltage supply range +Vs | 12 ... 28 VDC |
| current consumption max. (no load) | 80 mA |
| output circuit | RS 232 |
| baud rate | 38400, adjustable |
| short circuit protection | yes |
| reverse polarity protection | yes, Vs to GND |

mechanical data

| | |
|------------------|--------------------|
| width / diameter | 13,4 mm |
| height / length | 48,2 mm |
| depth | 40 mm |
| type | rectangular |
| housing material | aluminum |
| front (optics) | glass |
| connection types | connector M8 4 pin |

ambient conditions

| | |
|-----------------------|--------------|
| operating temperature | 0 ... +50 °C |
| protection class | IP 67 |

connection diagram

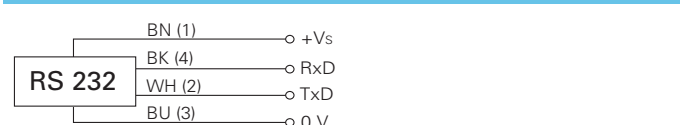

connectors

| | | |
|---------------|-------|-------------------------|
| ESG 34FP0200B | 8 pin | 2 m straight (shielded) |
| ESG 34FP0500B | 8 pin | 5 m straight (shielded) |

additional cable connectors and field wireable connectors, see accessories

accessories

| | |
|-----------------------|----------|
| SENSOFIX mounting kit | 10161829 |
| mounting bracket | 10161695 |

for details, see accessories section

laser warning



Complies with 21 CFR 1040.10 and 1040.11 except for deviations pursuant to laser notice No. 50, dated June 24, 2007

| order reference | measuring distance Sd | response time / release time | beam type | beam width | beam height | beam diameter | ambient light immunity |
|-------------------|-----------------------|------------------------------|-----------|------------|-------------|---------------|------------------------|
| OADM 13T6475/S35A | 50 ... 350 mm | < 0,9 ms | point | - | - | 1 mm | < 20 kLux |
| OADM 13T6575/S35A | 50 ... 350 mm | < 0,9 ms | line | 2 mm | 4 ... 9 mm | - | < 30 kLux |
| OADM 13T7480/S35A | 50 ... 550 mm | < 2 ms | point | - | - | 1 mm | < 100 kLux |
| OADM 13T7580/S35A | 50 ... 550 mm | < 2 ms | line | 2 mm | 4 ... 13 mm | - | < 100 kLux |

Photoelectric distance measuring sensors OADM 13 Sd = 50 ... 550 mm

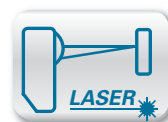

resolution

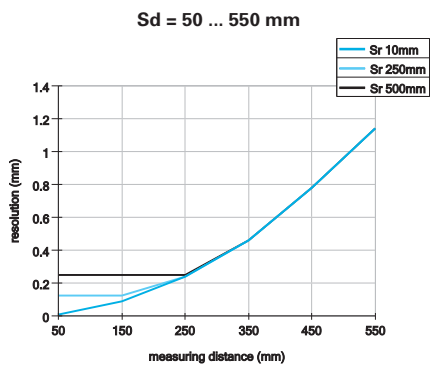
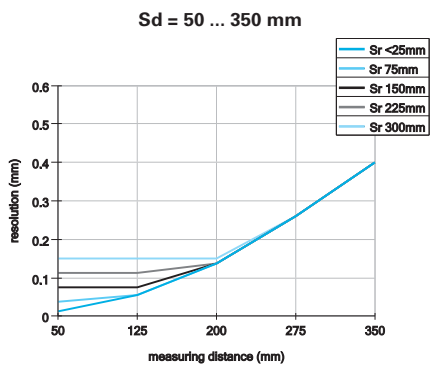

linearity errors

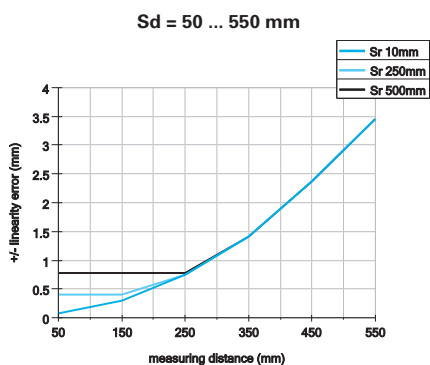
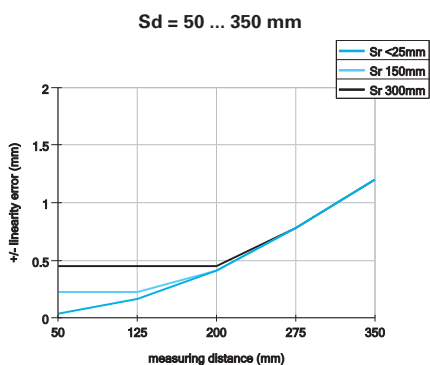

beam alignment (line)

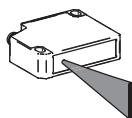

dimension drawing

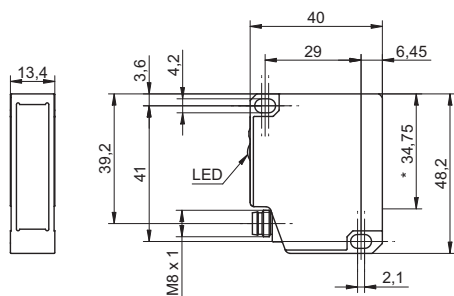

* emitter axis

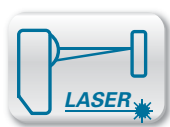

Sd = 50 ... 550 mm

- serial interface RS 485
- resolution up to 50 µm
- also with laser line for rough surfaces



general data

| | |
|---------------------|------------------------|
| adjustment | no |
| power on indication | LED green |
| light source | pulsed red laser diode |
| wave length | 650 nm |
| laser class | 2 |
| alarm indicator | LED red |

measuring distance Sd = 50 ... 350 mm

| | |
|-------------------|---------------------|
| resolution | 0,05 ... 0,4 mm |
| linearity error | ± 0,18 ... ± 1,2 mm |
| temperature drift | < 0,04 % Sde/K |

measuring distance Sd = 50 ... 550 mm

| | |
|-------------------|--------------------|
| resolution | 0,09 ... 1,15 mm |
| linearity error | ± 0,3 ... ± 3,5 mm |
| temperature drift | < 0,07 % Sde/K |

electrical data

| | |
|------------------------------------|-------------------|
| voltage supply range +Vs | 12 ... 28 VDC |
| current consumption max. (no load) | 80 mA |
| output circuit | RS 485 |
| baud rate | 38400, adjustable |
| short circuit protection | yes |
| reverse polarity protection | yes, Vs to GND |

mechanical data

| | |
|------------------|--------------------|
| width / diameter | 13,4 mm |
| height / length | 48,2 mm |
| depth | 40 mm |
| type | rectangular |
| housing material | aluminum |
| front (optics) | glass |
| connection types | connector M8 4 pin |

ambient conditions

| | |
|-----------------------|--------------|
| operating temperature | 0 ... +50 °C |
| protection class | IP 67 |

connection diagram

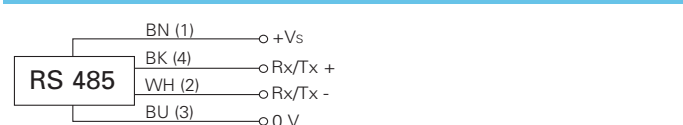

connectors

| | | |
|---------------|-------|-------------------------|
| ESG 32AP0200G | 4 pin | 2 m straight (shielded) |
| ESG 32AP0500G | 4 pin | 5 m straight (shielded) |
| ESW 31AP0500G | 4 pin | 5 m angular (shielded) |

additional cable connectors and field wireable connectors, see accessories

accessories

| | |
|-----------------------|----------|
| SENSOFIX mounting kit | 10161829 |
| mounting bracket | 10161695 |

for details, see accessories section

laser warning



Complies with 21 CFR 1040.10 and 1040.11 except for deviations pursuant to laser notice No. 50, dated June 24, 2007

| order reference | measuring distance Sd | response time / release time | beam type | beam width | beam height | beam diameter | ambient light immunity |
|-------------------|-----------------------|------------------------------|-----------|------------|-------------|---------------|------------------------|
| OADM 13S6475/S35A | 50 ... 350 mm | < 0,9 ms | point | - | - | 1 mm | < 20 kLux |
| OADM 13S6575/S35A | 50 ... 350 mm | < 0,9 ms | line | 2 mm | 4 ... 9 mm | - | < 30 kLux |
| OADM 13S7480/S35A | 50 ... 550 mm | < 2 ms | point | - | - | 1 mm | < 100 kLux |
| OADM 13S7580/S35A | 50 ... 550 mm | < 2 ms | line | 2 mm | 4 ... 13 mm | - | < 100 kLux |

Photoelectric distance measuring sensors Sd = 50 ... 550 mm

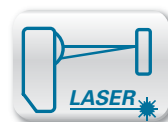

resolution

Sd = 50 ... 350 mm

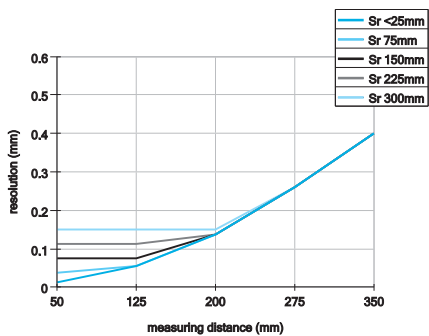

Sd = 50 ... 550 mm

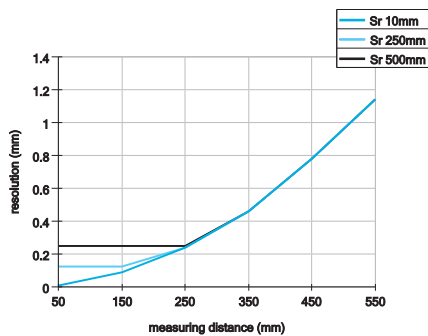

linearity errors

Sd = 50 ... 350 mm

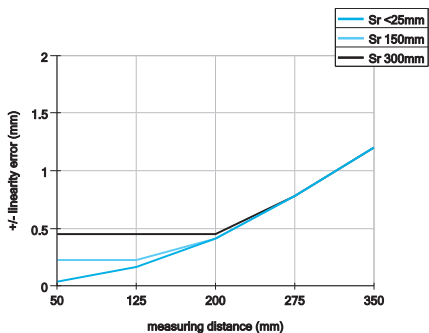

Sd = 50 ... 550 mm

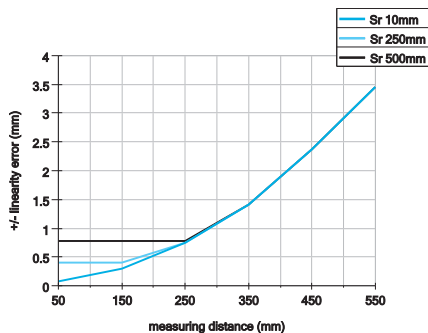

beam alignment (line)

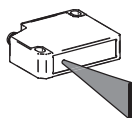

dimension drawing

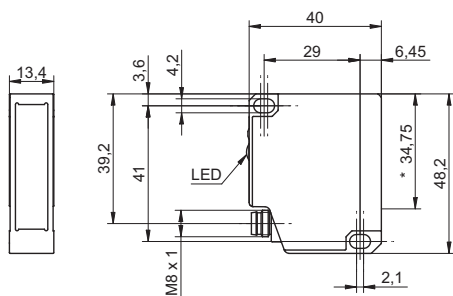

* emitter axis

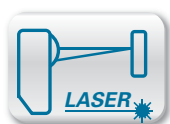

Sd = 50 ... 200 mm

- compact housing, voltage output
- high sensitivity
- fine laser line



general data

| | |
|--------------------------|-----------------------------|
| adjustment | Teach-in: button / external |
| power on indication | LED green |
| soiled lens indicator | LED red |
| light source | pulsed red laser diode |
| wave length | 650 nm |
| laser class | 1 |
| beam type | line |
| interference suppression | < 30 ms |
| temperature drift | < 0,07 % Sde/K |

measuring distance Sd = 50 ... 60 mm

| | |
|---------------------|------------|
| Teach-in range min. | > 1 mm |
| resolution | < 0,015 mm |
| linearity error | < 0,045 mm |
| object reflectivity | > 0,5 % |

measuring distance Sd = 60 ... 100 mm

| | |
|---------------------|------------------------|
| Teach-in range min. | > 4 mm |
| resolution | 0,015 ... 0,038 mm |
| linearity error | ± 0,047 ... ± 0,118 mm |
| object reflectivity | > 0,8 % |

measuring distance Sd = 100 ... 200 mm

| | |
|---------------------|------------------------|
| Teach-in range min. | > 5 mm |
| resolution | 0,039 ... 0,15 mm |
| linearity error | ± 0,123 ... ± 0,457 mm |
| object reflectivity | > 2 % |

electrical data

| | |
|------------------------------------|------------------------|
| response time / release time | < 2 ms |
| voltage supply range +Vs | 12 ... 28 VDC |
| current consumption max. (no load) | 100 mA |
| output circuit | analog |
| output signal | 4 ... 20 mA |
| load resistance | < (+Vs - 6 V) / 0,02 A |
| short circuit protection | yes |
| reverse polarity protection | yes, Vs to GND |

mechanical data

| | |
|------------------|--------------------|
| type | rectangular |
| housing material | aluminum |
| front (optics) | glass |
| connection types | connector M8 4 pin |

ambient conditions

| | |
|------------------------|--------------|
| ambient light immunity | < 100 kLux |
| operating temperature | 0 ... +50 °C |
| protection class | IP 67 |

order reference **measuring distance Sd**

| | |
|-------------------|----------------|
| OADM 1317730/S35A | 50 ... 60 mm |
| OADM 1317745/S35A | 60 ... 100 mm |
| OADM 1317760/S35A | 100 ... 200 mm |

connection diagram

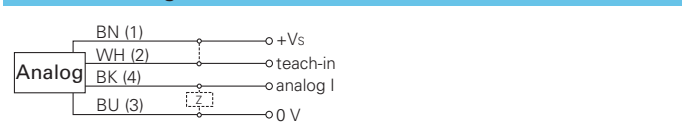

connectors

| | | |
|---------------|-------|-------------------------|
| ESG 32AP0200G | 4 pin | 2 m straight (shielded) |
| ESG 32AP0500G | 4 pin | 5 m straight (shielded) |
| ESW 31AP0500G | 4 pin | 5 m angular (shielded) |

additional cable connectors and field wireable connectors, see accessories

accessories

| | |
|-----------------------|----------|
| SENSOFIX mounting kit | 10161829 |
| mounting bracket | 10161695 |

for details, see accessories section

remarks

Missed measurement up to 15 cycles (30 ms) will be suppressed. During this time the analog output stays on hold.

laser warning



Complies with 21 CFR 1040.10 and 1040.11 except for deviations pursuant to laser notice No. 50, dated June 24, 2007

OADM 13 Sd = 50 ... 200 mm

Photoelectric distance measuring sensors

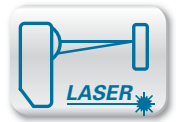

resolution

Sd = 50 ... 60 mm

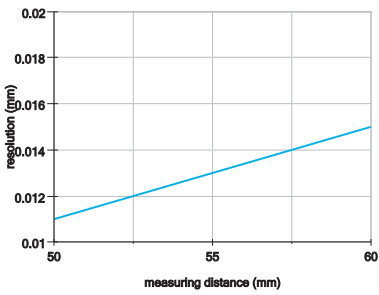

Sd = 60 ... 100 mm

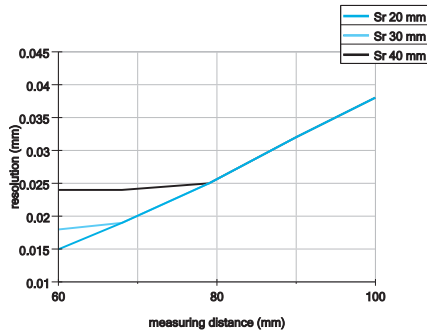

Sd = 100 ... 200 mm

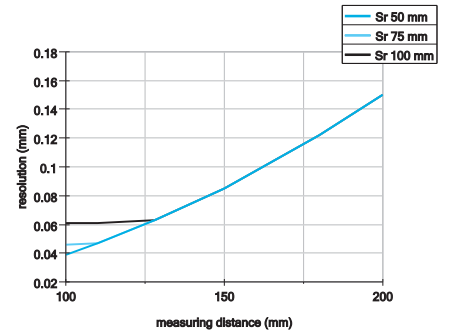

linearity errors

Sd = 50 ... 60 mm

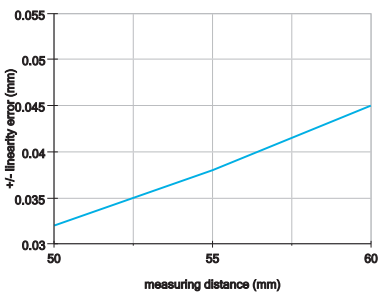

Sd = 60 ... 100 mm

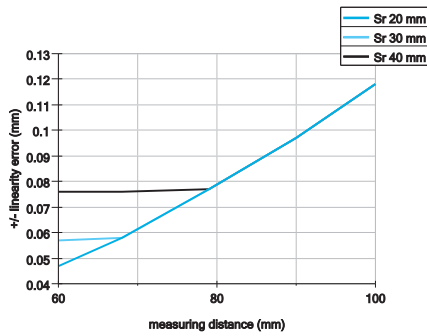

Sd = 100 ... 200 mm

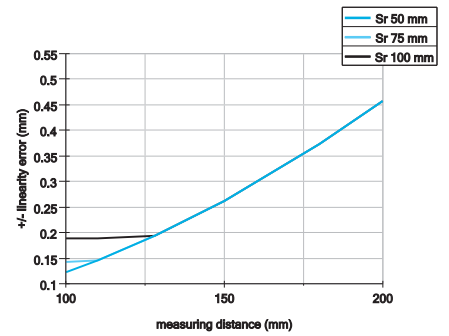

beam alignment (line)

Sd = 50 ... 60 mm

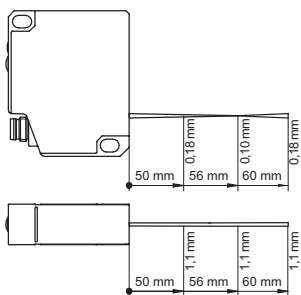

Sd = 60 ... 100 mm

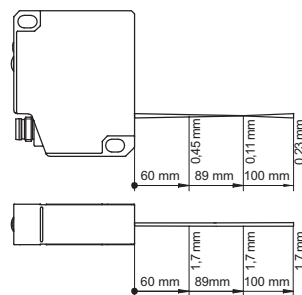

Sd = 100 ... 200 mm

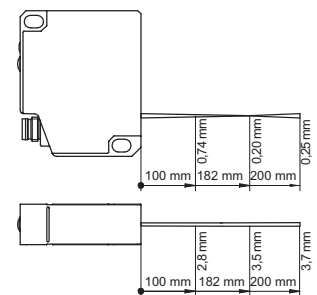

dimension drawing

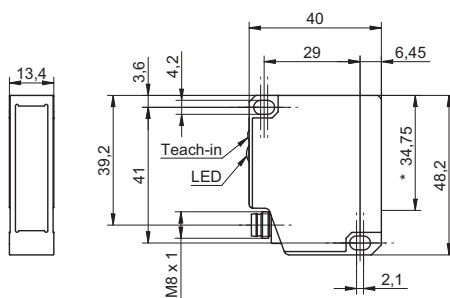

* emitter axis

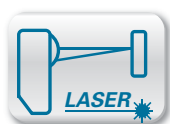

Sd = 50 ... 200 mm

- compact housing, voltage output
- high sensitivity
- fine laser line



general data

| | |
|--------------------------|-----------------------------|
| adjustment | Teach-in: button / external |
| power on indication | LED green |
| soiled lens indicator | LED red |
| light source | pulsed red laser diode |
| wave length | 650 nm |
| laser class | 1 |
| beam type | line |
| interference suppression | < 30 ms |
| temperature drift | < 0,07 % Sde/K |

measuring distance Sd = 50 ... 60 mm

| | |
|---------------------|------------|
| Teach-in range min. | > 1 mm |
| resolution | < 0,015 mm |
| linearity error | < 0,045 mm |
| object reflectivity | > 0,5 % |

measuring distance Sd = 60 ... 100 mm

| | |
|---------------------|------------------------|
| Teach-in range min. | > 4 mm |
| resolution | 0,015 ... 0,038 mm |
| linearity error | ± 0,047 ... ± 0,118 mm |
| object reflectivity | > 0,8 % |

measuring distance Sd = 100 ... 200 mm

| | |
|---------------------|------------------------|
| Teach-in range min. | > 5 mm |
| resolution | 0,039 ... 0,15 mm |
| linearity error | ± 0,123 ... ± 0,457 mm |
| object reflectivity | > 2 % |

electrical data

| | |
|------------------------------------|----------------|
| response time / release time | < 2 ms |
| voltage supply range +Vs | 12 ... 28 VDC |
| current consumption max. (no load) | 80 mA |
| output circuit | analog |
| output signal | 0 ... 10 VDC |
| load resistance | > 100 kOhm |
| short circuit protection | yes |
| reverse polarity protection | yes, Vs to GND |

mechanical data

| | |
|------------------|--------------------|
| type | rectangular |
| housing material | aluminum |
| front (optics) | glass |
| connection types | connector M8 4 pin |

ambient conditions

| | |
|------------------------|--------------|
| ambient light immunity | < 100 kLux |
| operating temperature | 0 ... +50 °C |
| protection class | IP 67 |

order reference **measuring distance Sd**

| | |
|-------------------|----------------|
| OADM 13U7730/S35A | 50 ... 60 mm |
| OADM 13U7745/S35A | 60 ... 100 mm |
| OADM 13U7760/S35A | 100 ... 200 mm |

connection diagram

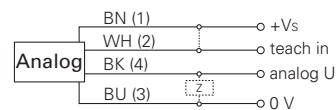

connectors

| | | |
|---------------|-------|-------------------------|
| ESG 32AP0200G | 4 pin | 2 m straight (shielded) |
| ESG 32AP0500G | 4 pin | 5 m straight (shielded) |
| ESW 31AP0500G | 4 pin | 5 m angular (shielded) |

additional cable connectors and field wireable connectors, see accessories

accessories

| | |
|-----------------------|----------|
| SENSOFIX mounting kit | 10161829 |
| mounting bracket | 10161695 |

for details, see accessories section

remarks

Missed measurement up to 15 cycles (30 ms) will be suppressed. During this time the analog output stays on hold.

laser warning



Complies with 21 CFR 1040.10 and 1040.11 except for deviations pursuant to laser notice No. 50, dated June 24, 2007

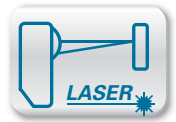

resolution

Sd = 50 ... 60 mm

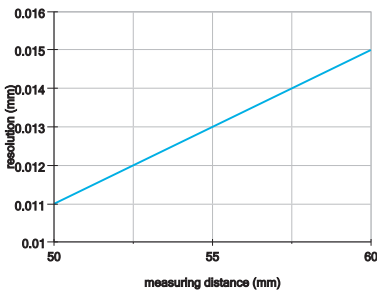

Sd = 60 ... 100 mm

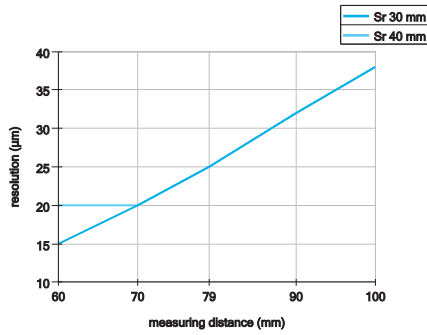

Sd = 100 ... 200 mm

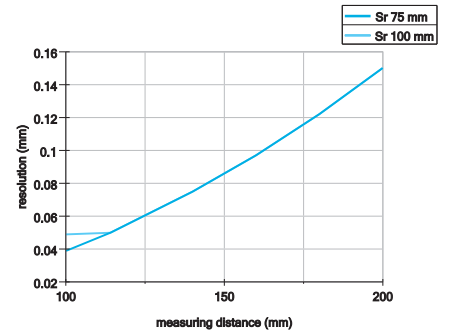

linearity errors

Sd = 50 ... 60 mm

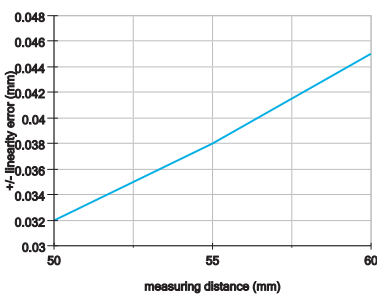

Sd = 60 ... 100 mm

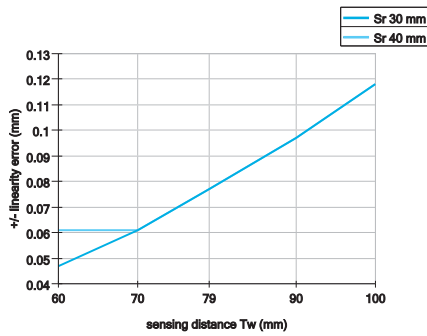

Sd = 100 ... 200 mm

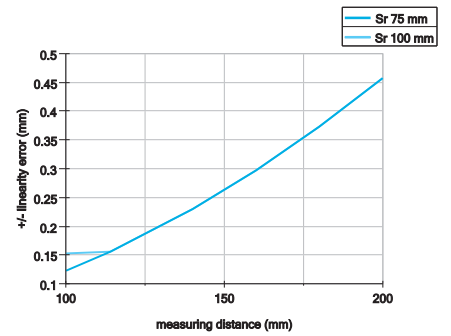

beam alignment (line)

Sd = 50 ... 60 mm

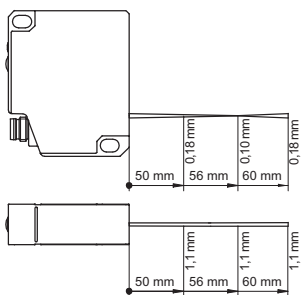

Sd = 60 ... 100 mm

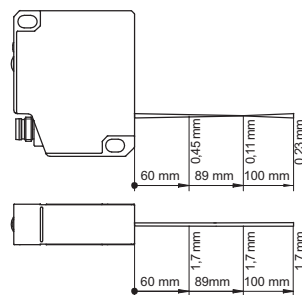

Sd = 100 ... 200 mm

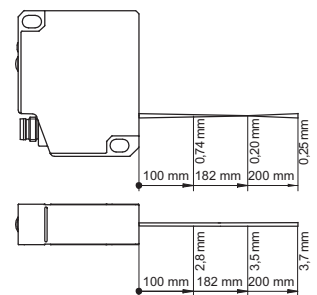

dimension drawing

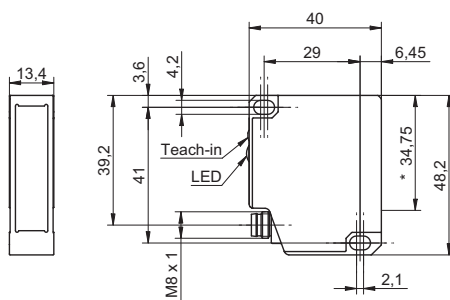

* emitter axis

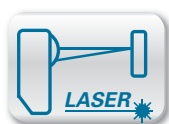

Sd = 30 ... 130 mm

- response time < 0,9 ms
- teachable measuring range Sr >2 mm



general data

| | |
|-----------------------|-----------------------------|
| adjustment | Teach-in: button / external |
| power on indication | LED green |
| soiled lens indicator | LED red |
| light source | pulsed red laser diode |
| wave length | 650 nm |
| laser class | 2 |
| beam type | point |

measuring distance Sd = 30 ... 70 mm

| | |
|---------------------|-----------------------|
| Teach-in range min. | > 2 mm |
| resolution | 0,004 ... 0,02 mm |
| linearity error | ± 0,012 ... ± 0,06 mm |
| beam diameter | 1 ... 0,2 mm |

measuring distance Sd = 30 ... 130 mm

| | |
|---------------------|----------------------|
| Teach-in range min. | > 3 mm |
| resolution | 0,005 ... 0,06 mm |
| linearity error | ± 0,015 ... ± 0,2 mm |
| beam diameter | 2 ... 1 mm |

electrical data

| | |
|------------------------------------|----------------|
| response time / release time | < 0,9 ms |
| voltage supply range +Vs | 12 ... 28 VDC |
| current consumption max. (no load) | 100 mA |
| output circuit | analog |
| short circuit protection | yes |
| reverse polarity protection | yes, Vs to GND |

mechanical data

| | |
|------------------|--------------------------------|
| width / diameter | 20,6 mm |
| height / length | 65 mm |
| depth | 50 mm |
| type | rectangular |
| housing material | die-cast zinc |
| front (optics) | glass |
| connection types | connector M12 5 pin, rotatable |

ambient conditions

| | |
|-----------------------|--------------|
| operating temperature | 0 ... +50 °C |
| protection class | IP 67 |

connection diagram

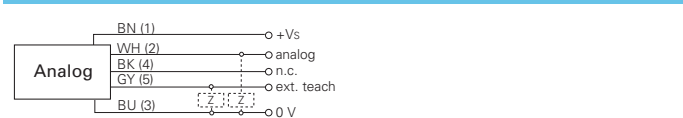

connectors

| | | |
|-----------|-------|-------------------------|
| ES 34CP2B | 5 pin | 2 m straight (shielded) |
| ES 34CP5B | 5 pin | 5 m straight (shielded) |

additional cable connectors and field wireable connectors, see accessories

accessories

| | |
|------------------|----------|
| mounting bracket | 10131521 |
| protector cap | 10156878 |

for details, see accessories section

remarks

Missed measurements up to 30 cycles will be suppressed. During this time the analog output stays on hold.

laser warning



**LASER RADIATION
DO NOT STARE INTO BEAM**
Wavelength: 620 ... 680nm
Max. av. Output: < 1mW
IEC 60825-1, Ed. 2, 2007
CLASS 2 LASER PRODUCT

Complies with 21 CFR 1040.10 and 1040.11 except for deviations pursuant to laser notice No. 50, dated June 24, 2007

| order reference | measuring distance Sd | output signal | load resistance (analog U) | load resistance (analog I) |
|-------------------|-----------------------|---------------|----------------------------|----------------------------|
| OADM 20I2441/S14C | 30 ... 70 mm | 4 ... 20 mA | - | < (+Vs - 6 V) / 0,02 A |
| OADM 20I2460/S14C | 30 ... 130 mm | 4 ... 20 mA | - | < (+Vs - 6 V) / 0,02 A |
| OADM 20U2441/S14C | 30 ... 70 mm | 0 ... 10 VDC | > 100 kOhm | - |
| OADM 20U2460/S14C | 30 ... 130 mm | 0 ... 10 VDC | > 100 kOhm | - |

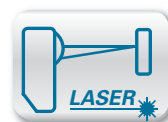

resolution

Sd = 30 ... 70 mm

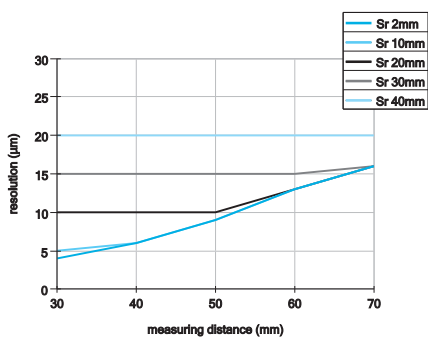

Sd = 30 ... 130 mm

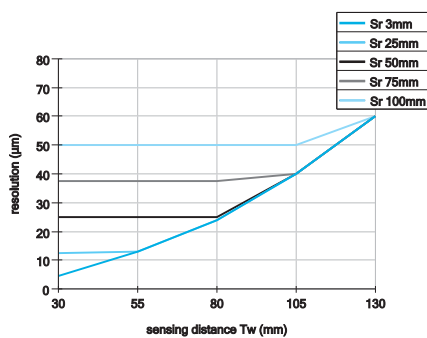

linearity errors

Sd = 30 ... 70 mm

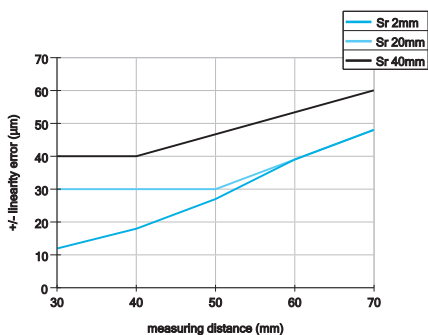

Sd = 30 ... 130 mm

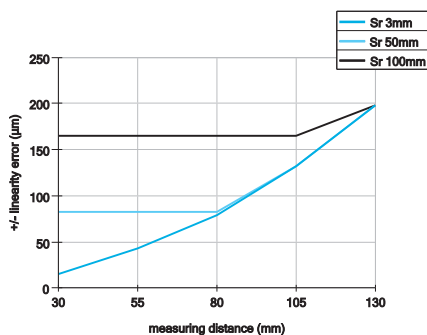

dimension drawing

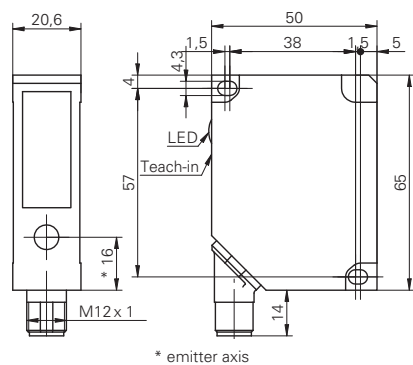

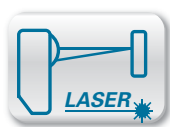

Sd = 50 ... 600 mm

- response time < 0,9 ms
- teachable measuring range Sr > 5 mm



general data

| | |
|-----------------------|-----------------------------|
| adjustment | Teach-in: button / external |
| power on indication | LED green |
| soiled lens indicator | LED red |
| light source | pulsed red laser diode |
| wave length | 650 nm |
| laser class | 2 |
| beam type | point |
| beam diameter | 2 mm |

measuring distance Sd = 50 ... 300 mm

| | |
|---------------------|-------------------|
| Teach-in range min. | > 5 mm |
| resolution | 0,01 ... 0,33 mm |
| linearity error | ± 0,03 ... ± 1 mm |

measuring distance Sd = 100 ... 600 mm

| | |
|---------------------|-------------------|
| Teach-in range min. | > 10 mm |
| resolution | 0,015 ... 0,67 mm |
| linearity error | ± 0,05 ... ± 2 mm |

electrical data

| | |
|------------------------------------|----------------|
| response time / release time | < 0,9 ms |
| voltage supply range +Vs | 12 ... 28 VDC |
| current consumption max. (no load) | 100 mA |
| output circuit | analog |
| short circuit protection | yes |
| reverse polarity protection | yes, Vs to GND |

mechanical data

| | |
|------------------|--------------------------------|
| width / diameter | 20,6 mm |
| height / length | 65 mm |
| depth | 50 mm |
| type | rectangular |
| housing material | die-cast zinc |
| front (optics) | glass |
| connection types | connector M12 5 pin, rotatable |

ambient conditions

| | |
|-----------------------|--------------|
| operating temperature | 0 ... +50 °C |
| protection class | IP 67 |

connection diagram

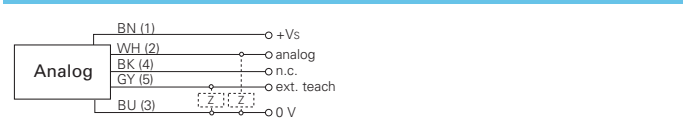

connectors

| | | |
|-----------|-------|-------------------------|
| ES 34CP2B | 5 pin | 2 m straight (shielded) |
| ES 34CP5B | 5 pin | 5 m straight (shielded) |

additional cable connectors and field wireable connectors, see accessories

accessories

| | |
|------------------|----------|
| mounting bracket | 10131521 |
| protector cap | 10156878 |

for details, see accessories section

remarks

For objects with a reflectivity < 7% (OADM 20x2480/S14C), the response / release time is increased automatically up to max. 2,8 ms. Missed measurements up to 30 cycles will be suppressed. During this time the analog output stays on hold.

laser warning



Complies with 21 CFR 1040.10 and 1040.11 except for deviations pursuant to laser notice No. 50, dated June 24, 2007

| order reference | measuring distance Sd | output signal | load resistance (analog U) | load resistance (analog I) |
|-------------------|-----------------------|---------------|----------------------------|----------------------------|
| OADM 20I2472/S14C | 50 ... 300 mm | 4 ... 20 mA | - | < (+Vs - 6 V) / 0,02 A |
| OADM 20I2480/S14C | 100 ... 600 mm | 4 ... 20 mA | - | < (+Vs - 6 V) / 0,02 A |
| OADM 20U2472/S14C | 50 ... 300 mm | 0 ... 10 VDC | > 100 kOhm | - |
| OADM 20U2480/S14C | 100 ... 600 mm | 0 ... 10 VDC | > 100 kOhm | - |

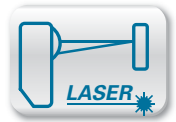

resolution

Sd = 50 ... 300 mm

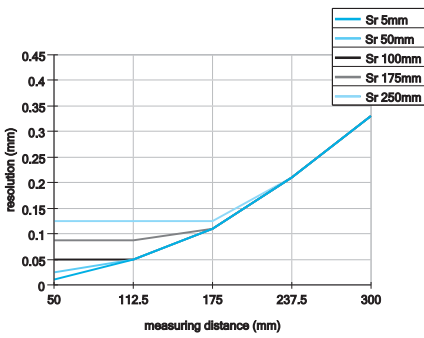

Sd = 100 ... 600 mm

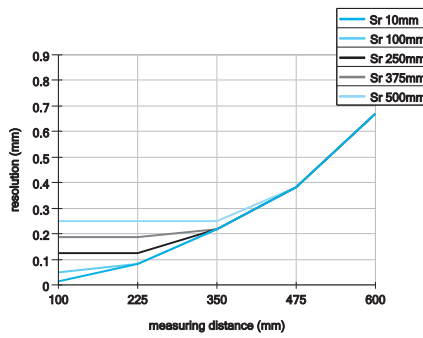

linearity errors

Sd = 50 ... 300 mm

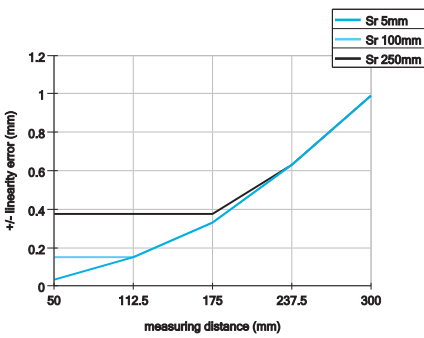

Sd = 100 ... 600 mm

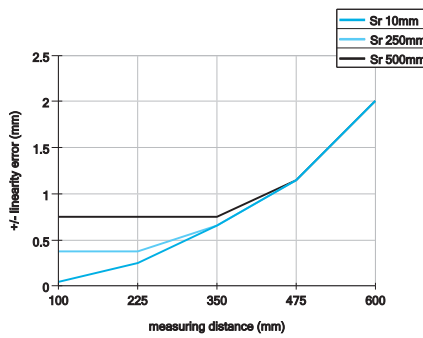

dimension drawing

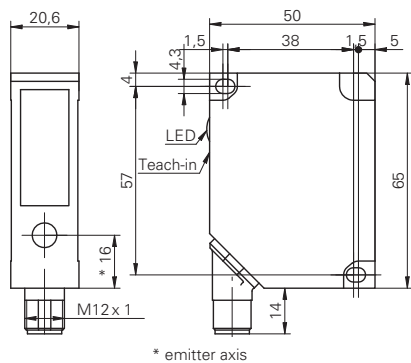

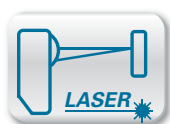

Sd = 30 ... 300 mm

- response time < 0,9 ms
- teachable measuring range Sr > 2 mm
- resolution up to 4 µm



general data

| | |
|-----------------------|-----------------------------|
| adjustment | Teach-in: button / external |
| power on indication | LED green |
| soiled lens indicator | LED red |
| light source | pulsed red laser diode |
| wave length | 650 nm |
| laser class | 2 |

measuring distance Sd = 30 ... 70 mm

| | |
|---------------------|-----------------------|
| Teach-in range min. | > 2 mm |
| resolution | 0,004 ... 0,02 mm |
| linearity error | ± 0,012 ... ± 0,06 mm |
| temperature drift | < 0,015 % Sde/K |

measuring distance Sd = 30 ... 130 mm

| | |
|---------------------|----------------------|
| Teach-in range min. | > 3 mm |
| resolution | 0,005 ... 0,06 mm |
| linearity error | ± 0,015 ... ± 0,2 mm |
| temperature drift | < 0,03 % Sde/K |

measuring distance Sd = 50 ... 300 mm

| | |
|---------------------|-------------------|
| Teach-in range min. | > 5 mm |
| resolution | 0,01 ... 0,33 mm |
| linearity error | ± 0,03 ... ± 1 mm |
| temperature drift | < 0,03 % Sde/K |

electrical data

| | |
|------------------------------------|----------------------------|
| response time / release time | < 0,9 ms |
| voltage supply range +Vs | 12 ... 28 VDC |
| current consumption max. (no load) | 100 mA |
| output circuit | analog |
| output signal | 4 ... 20 mA / 0 ... 10 VDC |
| load resistance (analog I) | < (+Vs - 6 V) / 0,02 A |
| load resistance (analog U) | > 100 kOhm |
| output current | < 100 mA |
| alarm output | PNP |
| short circuit protection | yes |
| reverse polarity protection | yes, Vs to GND |

mechanical data

| | |
|------------------|--------------------------------|
| type | rectangular |
| housing material | die-cast zinc |
| front (optics) | glass |
| connection types | connector M12 8 pin, rotatable |

ambient conditions

| | |
|-----------------------|--------------|
| operating temperature | 0 ... +50 °C |
| protection class | IP 67 |

| order reference | measuring distance Sd | beam type | beam width | beam height | beam diameter | ambient light immunity |
|-------------------|-----------------------|-----------|--------------|-------------|---------------|------------------------|
| OADM 20I6441/S14F | 30 ... 70 mm | point | - | - | 1 ... 0,2 mm | < 50 kLux |
| OADM 20I6460/S14F | 30 ... 130 mm | point | - | - | 2 ... 1 mm | < 40 kLux |
| OADM 20I6472/S14F | 50 ... 300 mm | point | - | - | 2 mm | < 8 kLux |
| OADM 20I6541/S14F | 30 ... 70 mm | line | 1 ... 0,2 mm | 2 mm | - | < 50 kLux |
| OADM 20I6560/S14F | 30 ... 130 mm | line | 2 ... 1 mm | 3 ... 5 mm | - | < 40 kLux |
| OADM 20I6572/S14F | 50 ... 300 mm | line | 2,5 mm | 4 ... 12 mm | - | < 8 kLux |

connection diagram

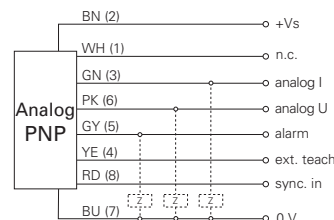

connectors

| | | |
|---------------|-------|-------------------------|
| ESG 34FP0200B | 8 pin | 2 m straight (shielded) |
| ESG 34FP0500B | 8 pin | 5 m straight (shielded) |

additional cable connectors and field wireable connectors, see accessories

accessories

| | |
|------------------|----------|
| mounting bracket | 10131521 |
| protector cap | 10156878 |

for details, see accessories section

laser warning

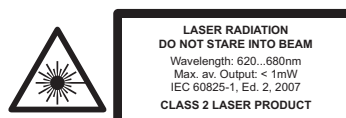

Complies with 21 CFR 1040.10 and 1040.11 except for deviations pursuant to laser notice No. 50, dated June 24, 2007

Photoelectric distance measuring sensors OADM 20 Sd = 30 ... 300 mm

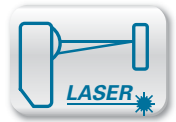

resolution

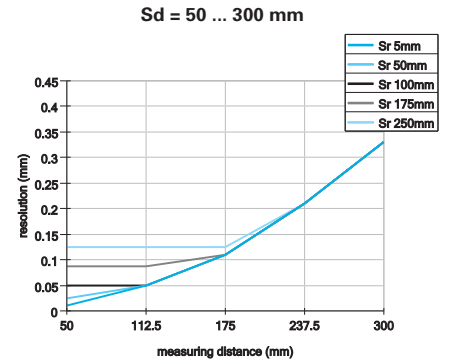
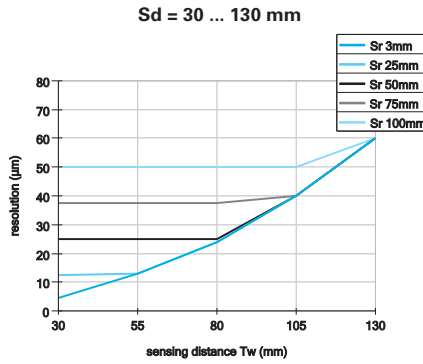
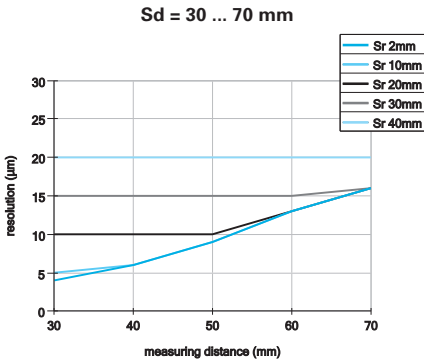

linearity errors

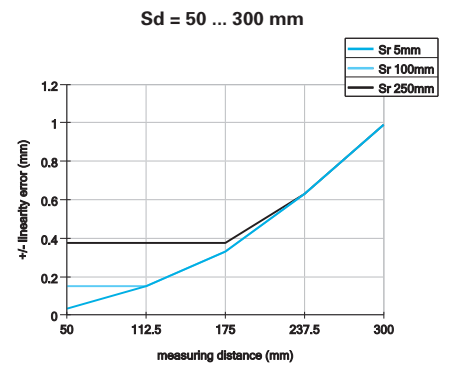
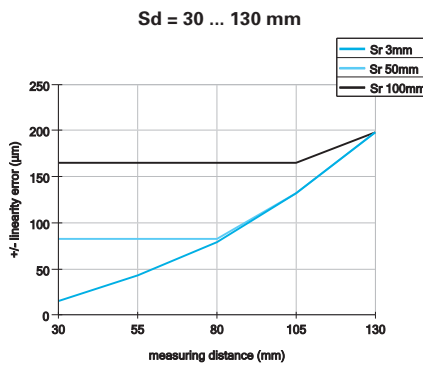
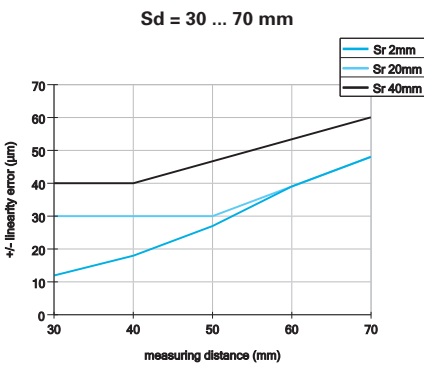

beam alignment (line)

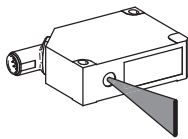

dimension drawing

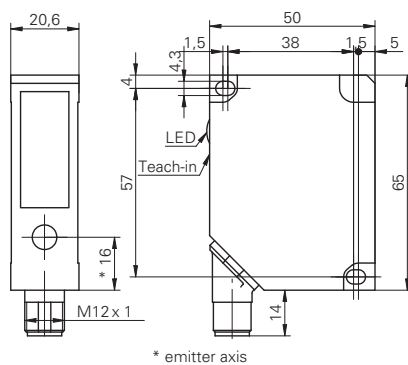

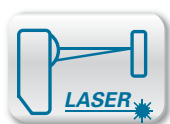

Sd = 100 ... 1000 mm

- response time < 0,9 ms
- teachable measuring range $S_r > 10$ mm
- resolution up to 15 μ m



general data

| | |
|-----------------------|-----------------------------|
| adjustment | Teach-in: button / external |
| power on indication | LED green |
| soiled lens indicator | LED red |
| light source | pulsed red laser diode |
| wave length | 650 nm |
| laser class | 2 |

measuring distance Sd = 100 ... 600 mm

| | |
|---------------------|---------------------------|
| Teach-in range min. | > 10 mm |
| resolution | 0,015 ... 0,67 mm |
| linearity error | $\pm 0,05$... ± 2 mm |
| temperature drift | < 0,03 % Sde/K |

measuring distance Sd = 200 ... 1000 mm

| | |
|---------------------|----------------------------|
| Teach-in range min. | > 20 mm |
| resolution | 0,12 ... 2,5 mm |
| linearity error | $\pm 0,48$... ± 10 mm |
| temperature drift | < 0,06 % Sde/K |

electrical data

| | |
|------------------------------------|----------------------------|
| response time / release time | < 0,9 ms |
| voltage supply range +Vs | 12 ... 28 VDC |
| current consumption max. (no load) | 100 mA |
| output circuit | analog |
| output signal | 4 ... 20 mA / 0 ... 10 VDC |
| load resistance (analog I) | < (+Vs - 6 V) / 0,02 A |
| load resistance (analog U) | > 100 kOhm |
| output current | < 100 mA |
| alarm output | PNP |
| short circuit protection | yes |
| reverse polarity protection | yes, Vs to GND |

mechanical data

| | |
|------------------|--------------------------------|
| width / diameter | 20,6 mm |
| height / length | 65 mm |
| depth | 50 mm |
| type | rectangular |
| housing material | die-cast zinc |
| front (optics) | glass |
| connection types | connector M12 8 pin, rotatable |

ambient conditions

| | |
|-----------------------|--------------|
| operating temperature | 0 ... +50 °C |
| protection class | IP 67 |

connection diagram

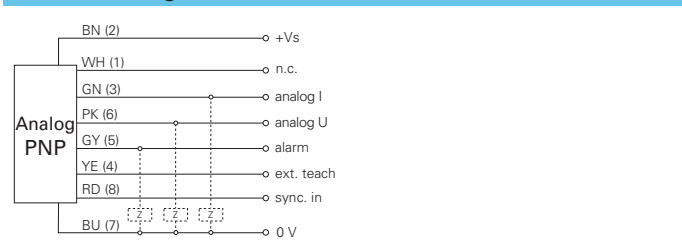

connectors

| | | |
|---------------|-------|-------------------------|
| ESG 34FP0200B | 8 pin | 2 m straight (shielded) |
| ESG 34FP0500B | 8 pin | 5 m straight (shielded) |

additional cable connectors and field wireable connectors, see accessories

accessories

| | |
|------------------|----------|
| mounting bracket | 10131521 |
| protector cap | 10156878 |

for details, see accessories section

remarks

For objects with a reflectivity < 7 % (OADM 2016x80/S14F) or < 15 % (OADM 2016x81/S14F) the response time/release time is increased automatically up to 2,8 ms.

laser warning

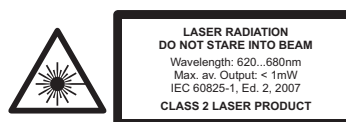

Complies with 21 CFR 1040.10 and 1040.11 except for deviations pursuant to laser notice No. 50, dated June 24, 2007

| order reference | measuring distance Sd | beam type | beam width | beam height | beam diameter | ambient light immunity |
|-------------------|-----------------------|-----------|------------|---------------|---------------|------------------------|
| OADM 2016480/S14F | 100 ... 600 mm | point | - | - | 2 mm | < 10 kLux |
| OADM 2016481/S14F | 200 ... 1000 mm | point | - | - | 2 mm | < 5 kLux |
| OADM 2016580/S14F | 100 ... 600 mm | line | 2,5 mm | 5,5 ... 21 mm | - | < 10 kLux |
| OADM 2016581/S14F | 200 ... 1000 mm | line | 2,5 mm | 8,5 ... 35 mm | - | < 5 kLux |

Photoelectric distance measuring sensors OADM 20 Sd = 100 ... 1000 mm

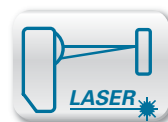

resolution

Sd = 100 ... 600 mm

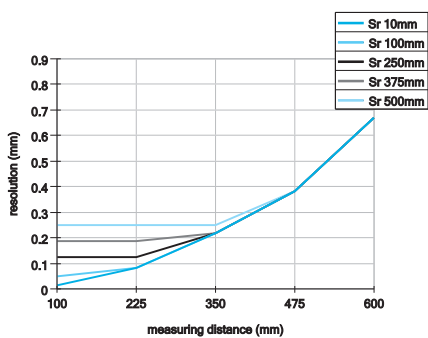

Sd = 200 ... 1000 mm

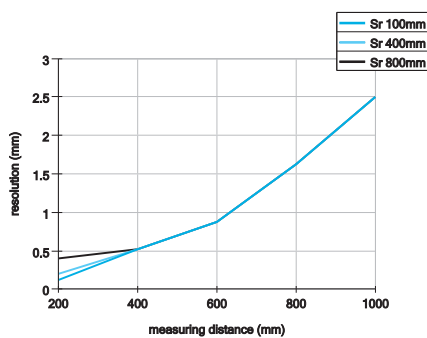

linearity errors

Sd = 100 ... 600 mm

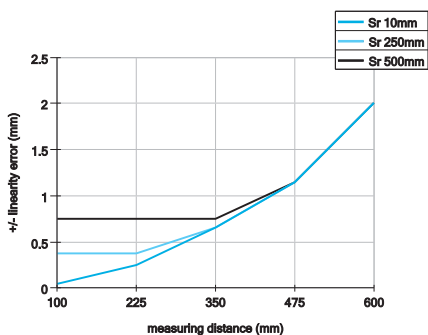

Sd = 200 ... 1000 mm

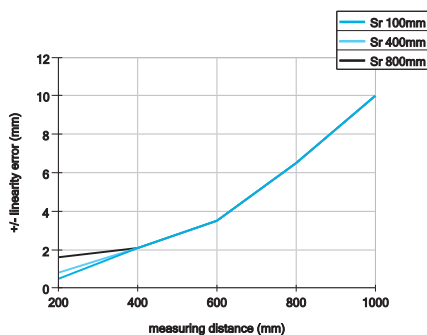

beam alignment (line)

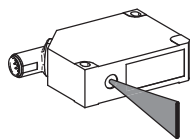

dimension drawing

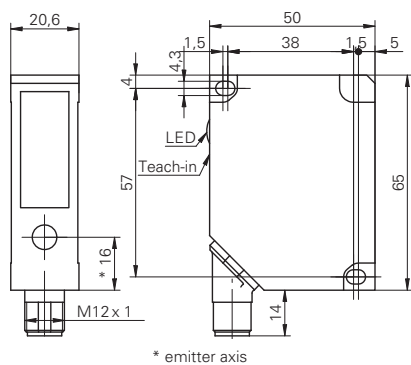

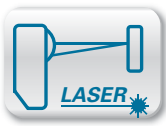

Sd = 30 ... 250 mm



- serial interface RS 485
- resolution up to 50 µm
- also with laser line for rough surfaces

general data

| | |
|-----------------------|------------------------|
| adjustment | no |
| power on indication | LED green |
| soiled lens indicator | LED red |
| light source | pulsed red laser diode |
| wave length | 650 nm |
| laser class | 2 |

measuring distance Sd = 30 ... 50 mm

| | |
|-------------------|-----------------|
| resolution | < 0,01 mm |
| linearity error | ± 0,03 mm |
| temperature drift | < 0,015 % Sde/K |

measuring distance Sd = 30 ... 130 mm

| | |
|-------------------|----------------------|
| resolution | 0,05 ... 0,07 mm |
| linearity error | ± 0,15 ... ± 0,22 mm |
| temperature drift | < 0,03 % Sde/K |

measuring distance Sd = 50 ... 250 mm

| | |
|-------------------|--------------------|
| resolution | 0,1 ... 0,3 mm |
| linearity error | ± 0,3 ... ± 0,8 mm |
| temperature drift | < 0,03 % Sde/K |

electrical data

| | |
|------------------------------------|----------------|
| response time / release time | < 10 ms |
| voltage supply range +Vs | 12 ... 28 VDC |
| current consumption max. (no load) | 100 mA |
| output circuit | RS 485 |
| baud rate | 19200 |
| output current | < 100 mA |
| alarm output | push-pull |
| short circuit protection | yes |
| reverse polarity protection | yes, Vs to GND |

mechanical data

| | |
|------------------|--------------------------------|
| width / diameter | 20,6 mm |
| height / length | 65 mm |
| depth | 50 mm |
| type | rectangular |
| housing material | die-cast zinc |
| front (optics) | glass |
| connection types | connector M12 8 pin, rotatable |

ambient conditions

| | |
|-----------------------|--------------|
| operating temperature | 0 ... +50 °C |
| protection class | IP 67 |

connection diagram

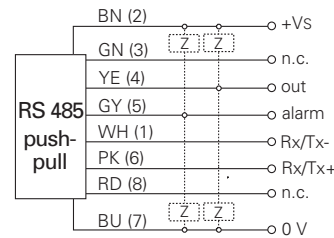

connectors

| | | |
|---------------|-------|-------------------------|
| ESG 34FP0200B | 8 pin | 2 m straight (shielded) |
| ESG 34FP0500B | 8 pin | 5 m straight (shielded) |

additional cable connectors and field wireable connectors, see accessories

accessories

| | |
|------------------|----------|
| mounting bracket | 10131521 |
| protector cap | 10156878 |

for details, see accessories section

remarks

The sensor has a switching output (out) that is activated when the measurement is determined within the range between threshold 1 and threshold 2. Both thresholds can be set via interface.

laser warning



Complies with 21 CFR 1040.10 and 1040.11 except for deviations pursuant to laser notice No. 50, dated June 24, 2007

| order reference | measuring distance Sd | beam type | beam width | beam height | beam diameter | ambient light immunity |
|-------------------|-----------------------|-----------|--------------|-------------|---------------|------------------------|
| OADM 20S4440/S14F | 30 ... 50 mm | point | - | - | 1 ... 0,4 mm | < 10 kLux |
| OADM 20S4460/S14F | 30 ... 130 mm | point | - | - | 2 ... 1 mm | < 7 kLux |
| OADM 20S4470/S14F | 50 ... 250 mm | point | - | - | 2 mm | < 3 kLux |
| OADM 20S4540/S14F | 30 ... 50 mm | line | 1 ... 0,4 mm | 2 mm | - | < 10 kLux |
| OADM 20S4560/S14F | 30 ... 130 mm | line | 2 ... 1 mm | 3 ... 5 mm | - | < 4 kLux |
| OADM 20S4570/S14F | 50 ... 250 mm | line | 2,5 mm | 4 ... 10 mm | - | < 2,5 kLux |

Photoelectric distance measuring sensors OADM 20 Sd = 30 ... 250 mm

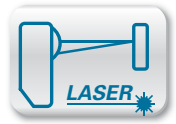

resolution

Sd = 30 ... 50 mm

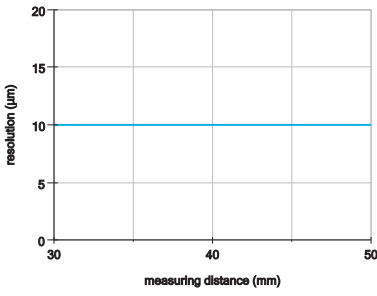

Sd = 30 ... 130 mm

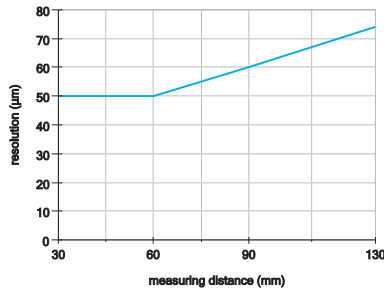

Sd = 50 ... 250 mm

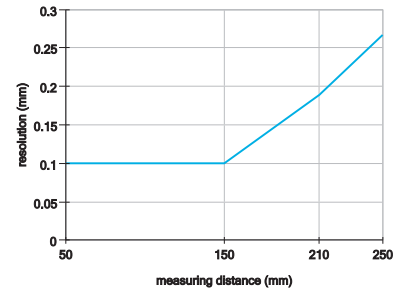

linearity errors

Sd = 30 ... 50 mm

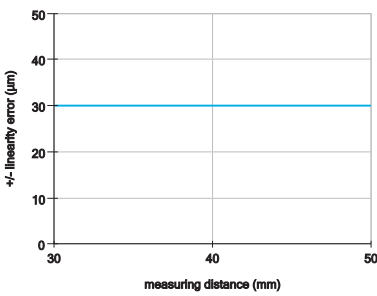

Sd = 30 ... 130 mm

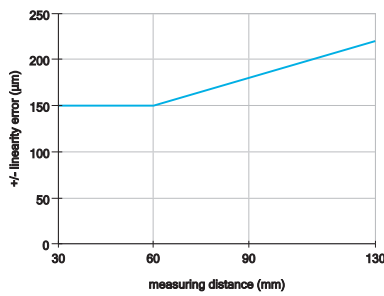

Sd = 50 ... 250 mm

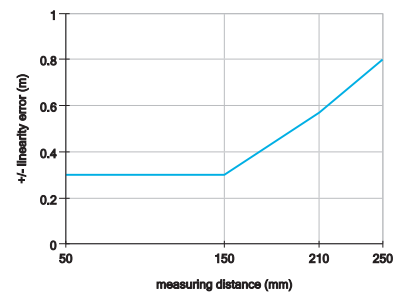

beam alignment (line)

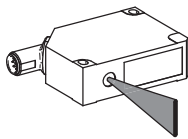

dimension drawing

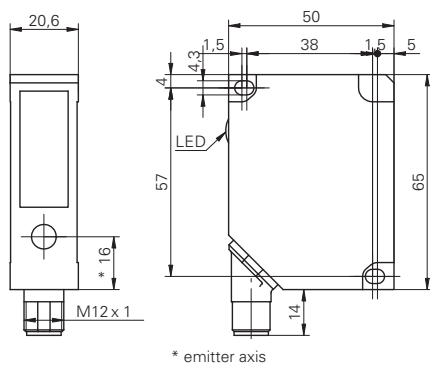

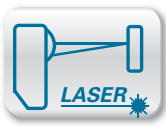

Sd = 100 ... 1000 mm



- serial interface RS 485
- resolution up to 0,2 mm
- also with laser line for rough surfaces

general data

| | |
|-----------------------|------------------------|
| adjustment | no |
| power on indication | LED green |
| soiled lens indicator | LED red |
| light source | pulsed red laser diode |
| wave length | 650 nm |
| laser class | 2 |

measuring distance Sd = 100 ... 500 mm

| | |
|-------------------|------------------|
| resolution | 0,2 ... 0,5 mm |
| linearity error | ± 0,8 ... ± 2 mm |
| temperature drift | < 0,04 % Sde/K |

measuring distance Sd = 200 ... 1000 mm

| | |
|-------------------|-------------------|
| resolution | 0,6 ... 2,5 mm |
| linearity error | ± 2,4 ... ± 10 mm |
| temperature drift | < 0,06 % Sde/K |

electrical data

| | |
|------------------------------------|----------------|
| response time / release time | < 10 ms |
| voltage supply range +Vs | 12 ... 28 VDC |
| current consumption max. (no load) | 100 mA |
| output circuit | RS 485 |
| baud rate | 19200 |
| output current | < 100 mA |
| alarm output | push-pull |
| short circuit protection | yes |
| reverse polarity protection | yes, Vs to GND |

mechanical data

| | |
|------------------|--------------------------------|
| width / diameter | 20,6 mm |
| height / length | 65 mm |
| depth | 50 mm |
| type | rectangular |
| housing material | die-cast zinc |
| front (optics) | glass |
| connection types | connector M12 8 pin, rotatable |

ambient conditions

| | |
|-----------------------|--------------|
| operating temperature | 0 ... +50 °C |
| protection class | IP 67 |

connection diagram

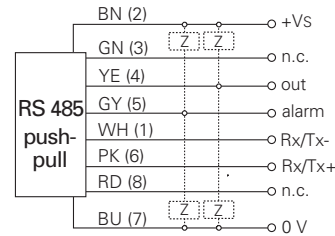

connectors

| | | |
|---------------|-------|-------------------------|
| ESG 34FP0200B | 8 pin | 2 m straight (shielded) |
| ESG 34FP0500B | 8 pin | 5 m straight (shielded) |

additional cable connectors and field wireable connectors, see accessories

accessories

| | |
|------------------|----------|
| mounting bracket | 10131521 |
| protector cap | 10156878 |

for details, see accessories section

remarks

The sensor has a switching output (out) that is activated when the measurement is determined within the range between threshold 1 and threshold 2. Both thresholds can be set via interface.

laser warning

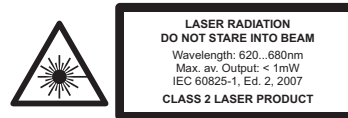

Complies with 21 CFR 1040.10 and 1040.11 except for deviations pursuant to laser notice No. 50, dated June 24, 2007

| order reference | measuring distance Sd | beam type | beam width | beam height | beam diameter | ambient light immunity |
|-------------------|-----------------------|-----------|------------|---------------|---------------|------------------------|
| OADM 20S4471/S14F | 100 ... 500 mm | point | - | - | 2 mm | < 16 kLux |
| OADM 20S4481/S14F | 200 ... 1000 mm | point | - | - | 2 mm | < 3 kLux |
| OADM 20S4571/S14F | 100 ... 500 mm | line | 2,5 mm | 5,5 ... 18 mm | - | < 12 kLux |
| OADM 20S4581/S14F | 200 ... 1000 mm | line | 2,5 mm | 8,5 ... 35 mm | - | < 2,5 kLux |

Photoelectric distance measuring sensors OADM 20 Sd = 100 ... 1000 mm

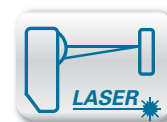

resolution

Sd = 100 ... 500 mm

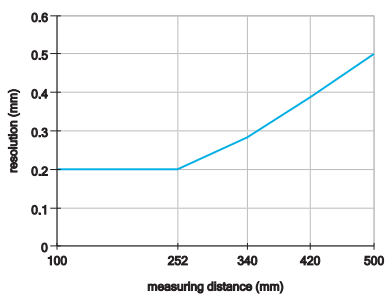

Sd = 200 ... 1000 mm

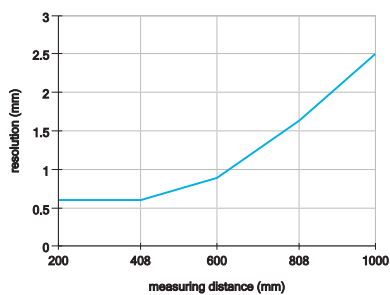

linearity errors

Sd = 100 ... 500 mm

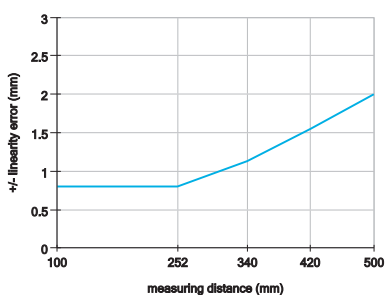

Sd = 200 ... 1000 mm

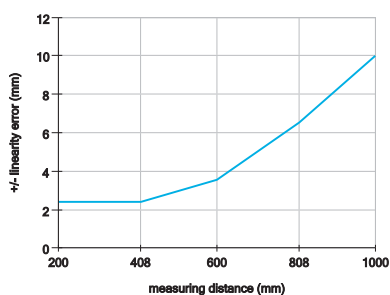

beam alignment (line)

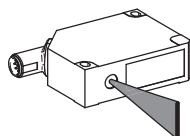

dimension drawing

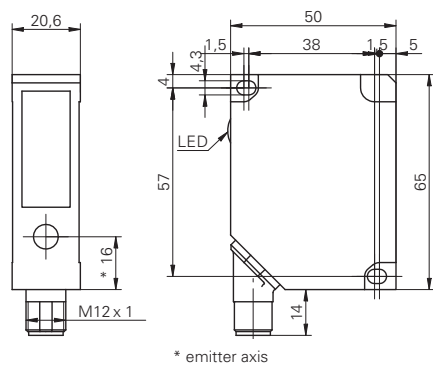

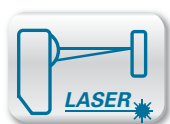

Sd = 50 ... 1000 mm

- for demanding applications
- very high ambient light immunity
- extremely vibration resistant



general data

| | |
|-----------------------|-----------------------------|
| adjustment | Teach-in: button / external |
| power on indication | LED green |
| soiled lens indicator | LED red |
| light source | pulsed red laser diode |
| wave length | 650 nm |
| laser class | 2 |
| beam type | line |
| temperature drift | < 0,04 % Sde/K |

measuring distance Sd = 50 ... 300 mm

| | |
|---------------------|--------------------|
| Teach-in range min. | > 5 mm |
| resolution | 0,01 ... 0,4 mm |
| linearity error | ± 0,2 ... ± 1,5 mm |
| beam width | 2 mm |
| beam height | 6 ... 11 mm |

measuring distance Sd = 100 ... 600 mm

| | |
|---------------------|--------------------|
| Teach-in range min. | > 10 mm |
| resolution | 0,015 ... 0,8 mm |
| linearity error | ± 0,5 ... ± 3,4 mm |
| beam width | 2 mm |
| beam height | 7 ... 17 mm |

measuring distance Sd = 200 ... 1000 mm

| | |
|---------------------|-------------------|
| Teach-in range min. | > 20 mm |
| resolution | 0,12 ... 3 mm |
| linearity error | ± 0,36 ... ± 9 mm |
| beam width | 3 ... 1 mm |
| beam height | 8 ... 25 mm |

electrical data

| | |
|------------------------------------|----------------------------|
| voltage supply range +Vs | 12 ... 28 VDC |
| current consumption max. (no load) | 100 mA |
| output signal | 4 ... 20 mA / 0 ... 10 VDC |
| load resistance (analog I) | < (+Vs - 6 V) / 0,02 A |
| load resistance (analog U) | > 100 kOhm |
| output current | < 100 mA |
| alarm output | PNP |
| reverse polarity protection | yes, Vs to GND |

mechanical data

| | |
|------------------|------------------|
| type | rectangular |
| housing material | die-cast zinc |
| front (optics) | glass |
| connection types | cable 8 pin, 2 m |

ambient conditions

| | |
|-----------------------|----------------|
| operating temperature | -20 ... +60 °C |
| protection class | IP 67 |

connection diagram

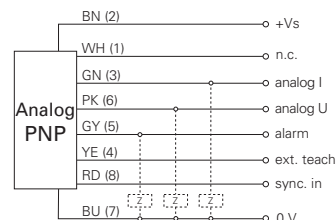

accessories

| | |
|------------------|----------|
| mounting bracket | 10131521 |
| protector cap | 10156878 |

for details, see accessories section

remarks

Fault suppression
If the laser beam is interrupted or if measurement faults occur, the analog outputs and the alarm output remain at their most recent valid value for a max. of 300 ms. Every valid value is immediately passed on to the outputs. If no valid value appears within 300 ms, the analog outputs switch to 4 mA / 0 V and the alarm output goes to HIGH.

Vibration stability:
- IEC 60068-2-6 (30 g, 10-2000 Hz, per axis)

Random stability:
- IEC 60068-2-64 (0,4 g2/Hz, 20-1000 Hz, per axis)

Bump stability:
- IEC 60068-2-29 (75 g, 6 ms, 4000 pulses per axis and direction)

laser warning



Complies with 21 CFR 1040.10 and 1040.11 except for deviations pursuant to laser notice No. 50, dated June 24, 2007

| order reference | measuring distance Sd | response time / release time | short circuit protection | ambient light immunity |
|-----------------|-----------------------|------------------------------|--------------------------|------------------------|
| OADM 2016591 | 50 ... 300 mm | < 2 ms | yes | < 100 kLux |
| OADM 2016592 | 100 ... 600 mm | < 2,5 ms | yes | < 100 kLux |
| OADM 2016593 | 200 ... 1000 mm | < 3,5 ms | - | < 60 kLux |

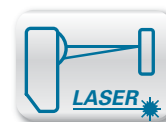

resolution

Sd = 50 ... 300 mm

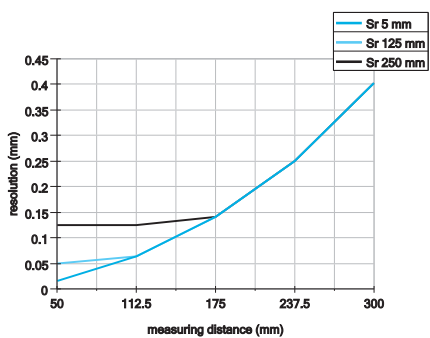

Sd = 100 ... 600 mm

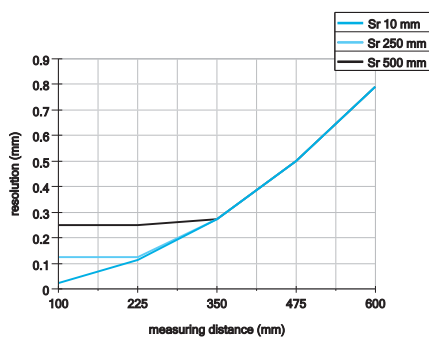

Sd = 200 ... 1000 mm

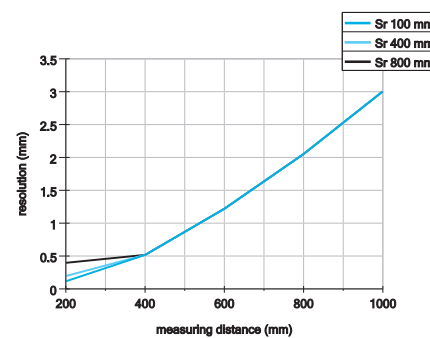

linearity errors

Sd = 50 ... 300 mm

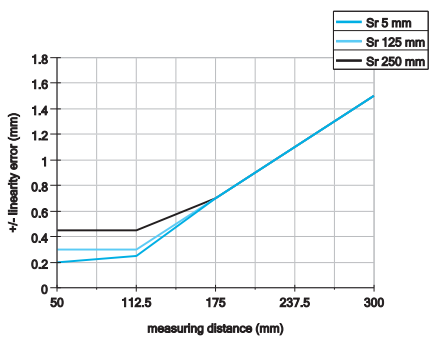

Sd = 100 ... 600 mm

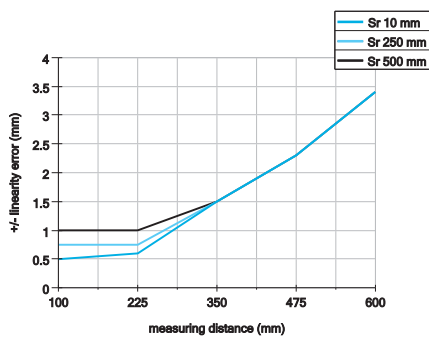

Sd = 200 ... 1000 mm

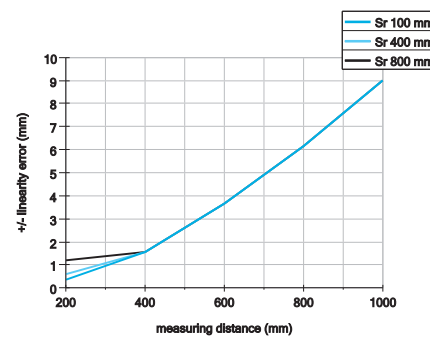

beam alignment (line)

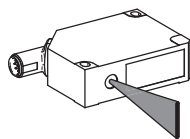

dimension drawing

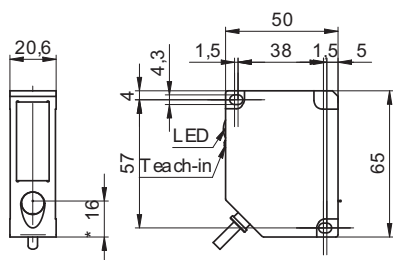

* emitter axis

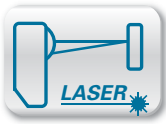

Sd = 30 ... 600 mm

- washdown design
- Ecolab approved
- front screen PMMA



general data

| | |
|------------------------|------------------------|
| special type | Washdown design |
| adjustment | external |
| power on indication | LED green |
| soiled lens indicator | LED red |
| light source | pulsed red laser diode |
| wave length | 650 nm |
| laser class | 2 |
| temperature drift | < 0,03 % Sde/K |
| Approvals/certificates | Ecolab |

measuring distance Sd = 30 ... 130 mm

| | |
|---------------------|----------------------|
| Teach-in range min. | > 3 mm |
| resolution | 0,005 ... 0,06 mm |
| linearity error | ± 0,015 ... ± 0,2 mm |

measuring distance Sd = 50 ... 300 mm

| | |
|---------------------|-------------------|
| Teach-in range min. | > 5 mm |
| resolution | 0,01 ... 0,33 mm |
| linearity error | ± 0,03 ... ± 1 mm |

measuring distance Sd = 100 ... 600 mm

| | |
|---------------------|-------------------|
| Teach-in range min. | > 10 mm |
| resolution | 0,015 ... 0,67 mm |
| linearity error | ± 0,05 ... ± 2 mm |

electrical data

| | |
|------------------------------------|----------------------------|
| response time / release time | < 0,9 ms |
| voltage supply range +Vs | 12 ... 28 VDC |
| current consumption max. (no load) | 100 mA |
| output circuit | analog |
| output signal | 4 ... 20 mA / 0 ... 10 VDC |
| load resistance (analog I) | < (+Vs - 6 V) / 0,02 A |
| load resistance (analog U) | > 100 kOhm |
| output current | < 100 mA |
| alarm output | PNP |
| short circuit protection | yes |
| reverse polarity protection | yes, Vs to GND |

mechanical data

| | |
|------------------|------------------------------|
| type | rectangular |
| housing material | stainless steel 1.4404 (V4A) |
| front (optics) | PMMA |
| connection types | connector M12 8 pin |

ambient conditions

| | |
|-----------------------|-------------------|
| operating temperature | 0 ... +50 °C |
| protection class | IP 69K & proTect+ |

| order reference | measuring distance Sd | beam type | beam width | beam height | beam diameter | ambient light immunity |
|-------------------|-----------------------|-----------|------------|---------------|---------------|------------------------|
| OADR 20I6465/S14F | 30 ... 130 mm | point | - | - | 2 ... 1 mm | < 40 kLux |
| OADR 20I6475/S14F | 50 ... 300 mm | point | - | - | 2 mm | < 8 kLux |
| OADR 20I6485/S14F | 100 ... 600 mm | point | - | - | 2 mm | < 10 kLux |
| OADR 20I6565/S14F | 30 ... 130 mm | line | 2 ... 1 mm | 3 ... 5 mm | - | < 40 kLux |
| OADR 20I6575/S14F | 50 ... 300 mm | line | 2,5 mm | 4 ... 12 mm | - | < 8 kLux |
| OADR 20I6585/S14F | 100 ... 600 mm | line | 2,5 mm | 5,5 ... 21 mm | - | < 10 kLux |

connection diagram

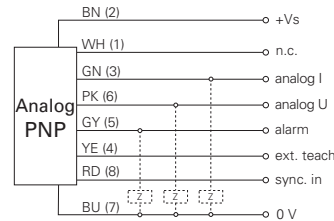

connectors

| | | |
|---------------|-------|-------------------------|
| ESG 34FP0200B | 8 pin | 2 m straight (shielded) |
| ESG 34FP0500B | 8 pin | 5 m straight (shielded) |

additional cable connectors and field wireable connectors, see accessories

remarks

For objects with a reflectivity < 7 % (OADR 20I6x85/S14F) the response time/release time is increased automatically up to 2.8 ms.

laser warning

Complies with 21 CFR 1040.10 and 1040.11 except for deviations pursuant to laser notice No. 50, dated June 24, 2007

OADR 20 Sd = 30 ... 600 mm Photoelectric distance measuring sensors

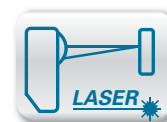

resolution

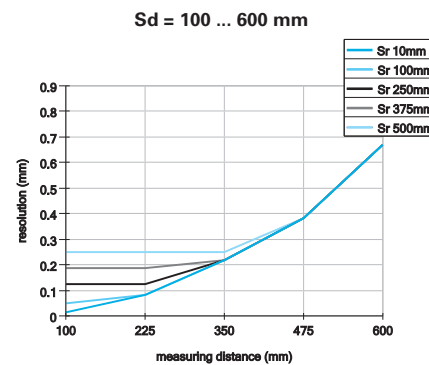
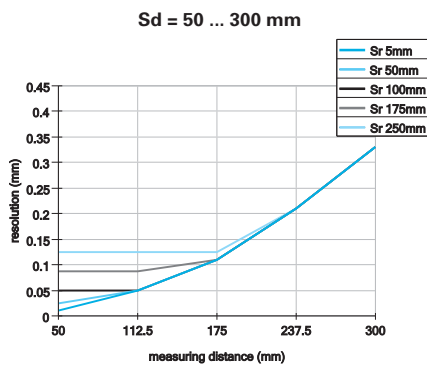
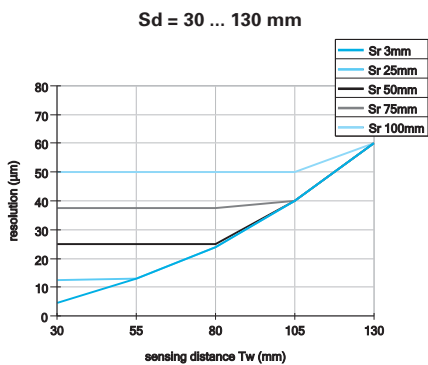

linearity errors

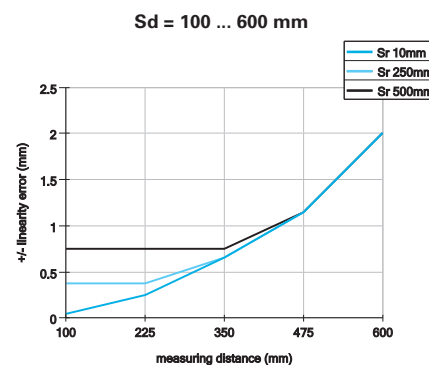
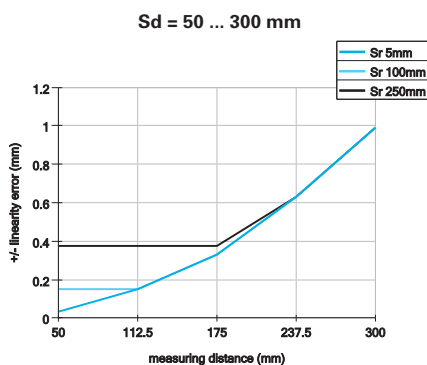
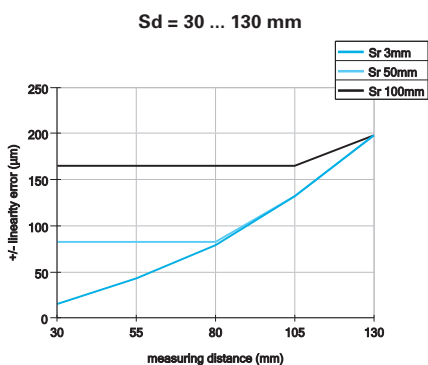

beam alignment (line)

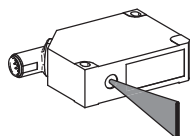

dimension drawing

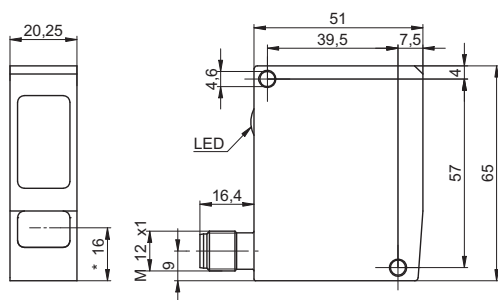

* emitter axis

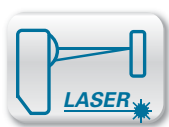

Sd = 100 ... 1000 mm

- teachable measuring range $S_r > 10$ mm
- resolution up to $10 \mu\text{m}$
- synchronization input

general data

| | |
|-----------------------|-----------------------------|
| adjustment | Teach-in: button / external |
| Teach-in range min. | > 10 mm |
| power on indication | LED green |
| soiled lens indicator | LED red |
| light source | pulsed red laser diode |
| wave length | 650 nm |
| laser class | 2 |

measuring distance Sd = 100 ... 600 mm

| | |
|-------------------|---------------------------|
| resolution | 0,01 ... 0,25 mm |
| linearity error | $\pm 0,07 \dots \pm 1$ mm |
| temperature drift | < 0,012 % Sde/K |

measuring distance Sd = 200 ... 1000 mm

| | |
|-------------------|------------------------------|
| resolution | 0,02 ... 0,4 mm |
| linearity error | $\pm 0,11 \dots \pm 1,65$ mm |
| temperature drift | < 0,02 % Sde/K |

electrical data

| | |
|------------------------------------|----------------------------|
| response time / release time | < 4 ms |
| voltage supply range +Vs | 12 ... 28 VDC |
| current consumption max. (no load) | 100 mA |
| output circuit | analog |
| output signal | 4 ... 20 mA / 0 ... 10 VDC |
| load resistance (analog I) | < (+Vs - 6 V) / 0,02 A |
| load resistance (analog U) | > 100 kOhm |
| output current | < 100 mA |
| alarm output | PNP |
| short circuit protection | yes |
| reverse polarity protection | yes, Vs to GND |

mechanical data

| | |
|------------------|--------------------------------|
| width / diameter | 20,4 mm |
| height / length | 135 mm |
| depth | 45 mm |
| type | rectangular |
| housing material | aluminum |
| front (optics) | glass |
| connection types | connector M12 8 pin, rotatable |

ambient conditions

| | |
|------------------------|--------------|
| ambient light immunity | < 10 kLux |
| operating temperature | 0 ... +50 °C |
| protection class | IP 67 |



connection diagram

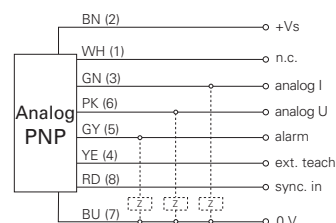

connectors

| | | |
|---------------|-------|-------------------------|
| ESG 34FP0200B | 8 pin | 2 m straight (shielded) |
| ESG 34FP0500B | 8 pin | 5 m straight (shielded) |

additional cable connectors and field wireable connectors, see accessories

laser warning



Complies with 21 CFR 1040.10 and 1040.11 except for deviations pursuant to laser notice No. 50, dated June 24, 2007

| order reference | measuring distance Sd | beam type | beam width | beam height | beam diameter |
|-------------------|-----------------------|-----------|------------|-------------|---------------|
| OADM 21I6480/S14F | 100 ... 600 mm | point | - | - | 2 mm |
| OADM 21I6481/S14F | 200 ... 1000 mm | point | - | - | 2 mm |
| OADM 21I6580/S14F | 100 ... 600 mm | line | 2 mm | 4 ... 13 mm | - |
| OADM 21I6581/S14F | 200 ... 1000 mm | line | 2,5 mm | 6 ... 20 mm | - |

OADM 21 Sd = 100 ... 1000 mm Photoelectric distance measuring sensors

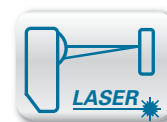

resolution

Sd = 100 ... 600 mm

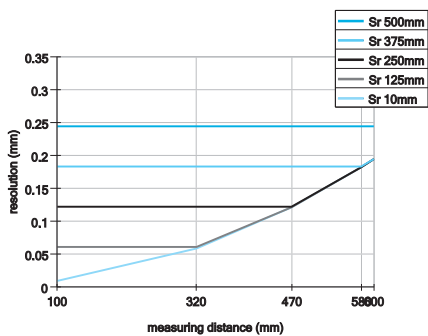

Sd = 200 ... 1000 mm

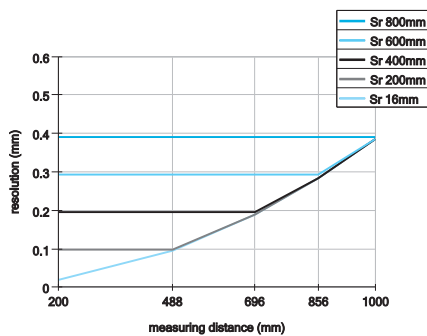

linearity errors

Sd = 100 ... 600 mm

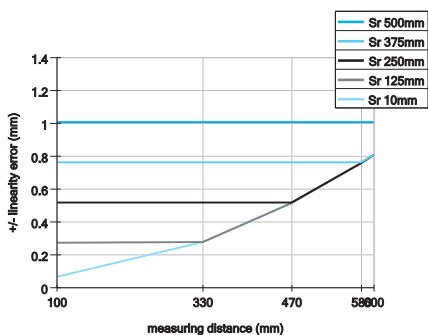

Sd = 200 ... 1000 mm

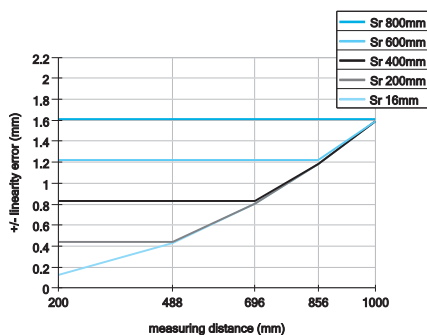

beam alignment (line)

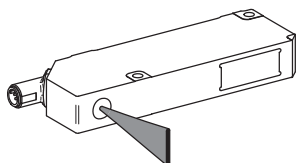

dimension drawing

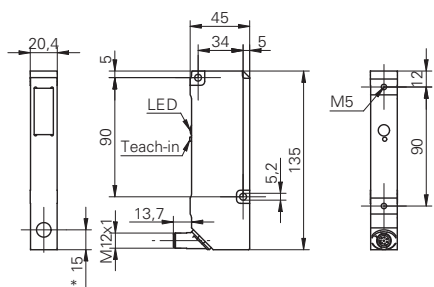

* emitter axis

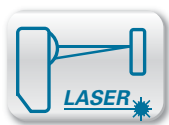

Sd = 100 ... 1000 mm



- qTeach
- alarm output

general data

| | |
|--------------------------|------------------------|
| measuring distance Sd | 100 ... 1000 mm |
| adjustment | Teach-in |
| Teach-in range min. | > 50 mm |
| power on indication | LED green |
| soiled lens indicator | LED red |
| resolution | 0,3 ... 4 mm |
| linearity error | ± 1,1 ... ± 15 mm |
| light source | pulsed red laser diode |
| wave length | 656 nm |
| laser class | 1 |
| beam type | point |
| beam diameter | 3,7 ... 13 mm |
| interference suppression | < 32 ms |

electrical data

| | |
|------------------------------------|----------------|
| response time / release time | < 12,8 ms |
| voltage supply range +Vs | 12 ... 30 VDC |
| current consumption max. (no load) | 80 mA |
| output circuit | analog |
| output current | < 100 mA |
| alarm output | push-pull |
| short circuit protection | yes |
| reverse polarity protection | yes, Vs to GND |

mechanical data

| | |
|------------------|--------------------------|
| width / diameter | 23,4 mm |
| height / length | 63 mm |
| depth | 45 mm |
| type | rectangular |
| housing material | plastic (SAN LURAN 378P) |
| front (optics) | PMMA |
| connection types | connector M12 5 pin |

ambient conditions

| | |
|------------------------|--------------|
| ambient light immunity | < 20 kLux |
| operating temperature | 0 ... +50 °C |
| protection class | IP 67 |

connection diagrams

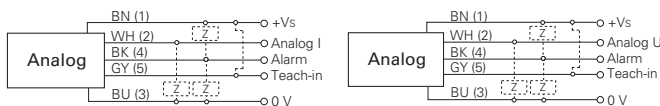

laser warning



Complies with 21 CFR 1040.10 and 1040.11 except for deviations pursuant to laser notice No. 50, dated June 24, 2007

| order reference | output signal | load resistance (analog U) | load resistance (analog I) |
|-------------------|---------------|----------------------------|----------------------------|
| OADK 25I7480/S14C | 4 ... 20 mA | - | < (+Vs - 6 V) / 0,02 A |
| OADK 25U7480/S14C | 0 ... 10 VDC | > 100 kOhm | - |

OADK 25 Sd = 100 ... 1000 mm

Photoelectric distance measuring sensors

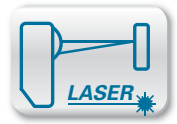

resolution

Sd = 100 ... 1000 mm

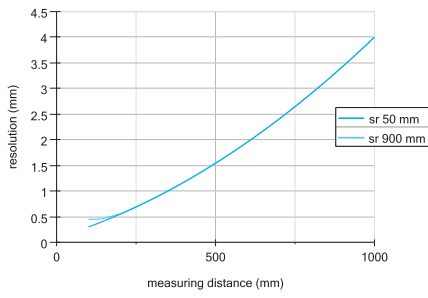

linearity error

Sd = 100 ... 1000 mm

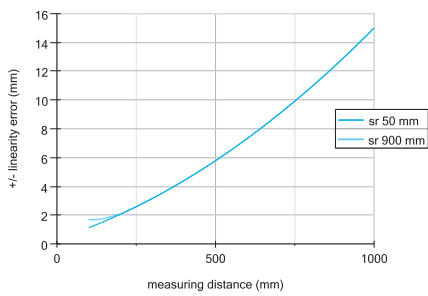

dimension drawing

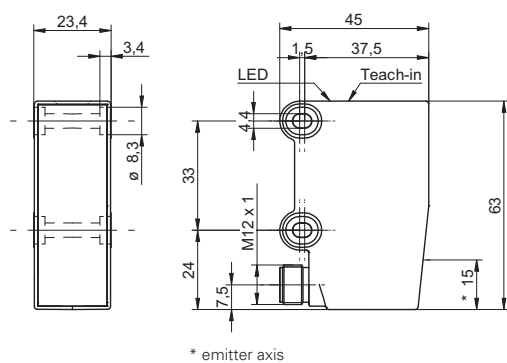

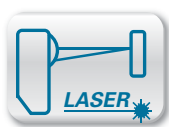

Sd = 0,2 ... 4 m

- measuring independent of colors up to 4 m
- extremely compact housing
- teachable measuring range



general data

| | |
|-----------------------------------|-------------------------------------|
| measuring distance Sd | 200 ... 4000 mm |
| measuring distance Sd (white 90%) | 200 ... 4000 mm |
| measuring distance Sd (grey 18%) | 200 ... 4000 mm |
| measuring distance Sd (black 6%) | 200 ... 4000 mm |
| adjustment | Teach-in: button / external |
| Teach-in range min. | > 100 mm |
| power on indication | LED green |
| soiled lens indicator | LED red |
| resolution | 1,3 mm |
| linearity | ± 15 mm |
| repeatability | ± 5 mm (with 40 kLux ambient light) |
| light source | pulsed red laser diode |
| wave length | 660 nm |
| laser class | 2 |
| beam type | point |
| beam diameter | 5 ... 20 mm |

electrical data

| | |
|------------------------------------|----------------------------|
| measuring rate | 10 ms |
| voltage supply range +Vs | 15 ... 28 VDC |
| current consumption max. (no load) | 250 mA (typ. 110 mA @ 24V) |
| output circuit | analog |
| output current | < 100 mA |
| alarm output | push-pull |
| short circuit protection | yes |
| reverse polarity protection | yes, Vs to GND |

mechanical data

| | |
|------------------|--------------------------------|
| width / diameter | 25,4 mm |
| height / length | 66 mm |
| depth | 51 mm |
| type | rectangular |
| housing material | aluminum |
| front (optics) | glass |
| connection types | connector M12 5 pin, rotatable |

ambient conditions

| | |
|------------------------|----------------|
| ambient light immunity | < 40 kLux |
| operating temperature | -25 ... +50 °C |
| protection class | IP 67 |
| typ. temp. coefficient | 0,2 mm /°C |

| order reference | output signal | load resistance (analog U) | load resistance (analog I) |
|--------------------|---------------|----------------------------|----------------------------|
| OADM 250I1101/S14C | 4 ... 20 mA | - | < (+Vs - 6 V) / 0,02 A |
| OADM 250U1101/S14C | 0 ... 10 VDC | > 10 kOhm | - |

connection diagram

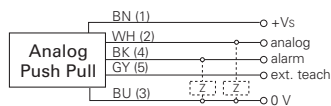

connectors

| | | |
|-----------|-------|-------------------------|
| ES 34CP2B | 5 pin | 2 m straight (shielded) |
| ES 34CP5B | 5 pin | 5 m straight (shielded) |

additional cable connectors and field wireable connectors, see accessories

accessories

| | |
|--------------|----------|
| mounting kit | 11010227 |
|--------------|----------|

for details, see accessories section

laser warning

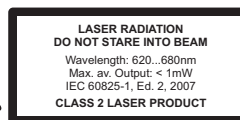

Complies with 21 CFR 1040.10 and 1040.11 except for deviations pursuant to laser notice No. 50, dated June 24, 2007

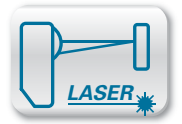

dimension drawing

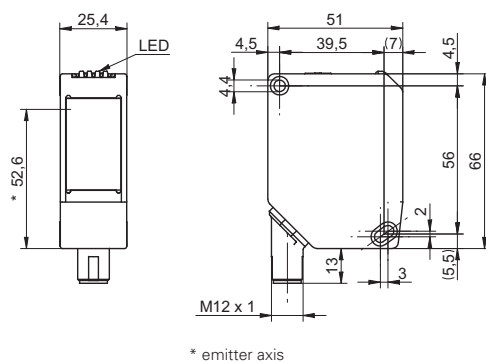

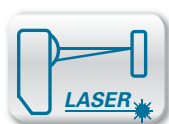

Sd = 0,2 ... 13 m

- measuring up to 13 m
- extremely compact housing
- teachable measuring range



general data

| | |
|-----------------------------------|--------------------------------------|
| measuring distance Sd | 200 ... 13000 mm |
| measuring distance Sd (white 90%) | 200 ... 13000 mm |
| measuring distance Sd (grey 18%) | 200 ... 9000 mm |
| measuring distance Sd (black 6%) | 200 ... 4000 mm |
| adjustment | Teach-in: button / external |
| Teach-in range min. | > 100 mm |
| power on indication | LED green |
| soiled lens indicator | LED red |
| resolution | 5 mm |
| linearity | ± 15 mm |
| repeatability | ± 15 mm (with 40 kLux ambient light) |
| light source | pulsed red laser diode |
| wave length | 660 nm |
| laser class | 2 |
| beam type | point |
| beam diameter | 5 ... 50 mm |

electrical data

| | |
|------------------------------------|----------------------------|
| measuring rate | 10 ms |
| voltage supply range +Vs | 15 ... 28 VDC |
| current consumption max. (no load) | 250 mA (typ. 110 mA @ 24V) |
| output circuit | analog |
| output signal | 4 ... 20 mA |
| load resistance (analog I) | < (+Vs - 6 V) / 0,02 A |
| output current | < 100 mA |
| alarm output | push-pull |
| short circuit protection | yes |
| reverse polarity protection | yes, Vs to GND |

mechanical data

| | |
|------------------|--------------------------------|
| width / diameter | 25,4 mm |
| height / length | 66 mm |
| depth | 51 mm |
| type | rectangular |
| housing material | aluminum |
| front (optics) | glass |
| connection types | connector M12 5 pin, rotatable |

ambient conditions

| | |
|------------------------|----------------|
| ambient light immunity | < 40 kLux |
| operating temperature | -25 ... +50 °C |
| protection class | IP 67 |
| typ. temp. coefficient | 0,4 mm /°C |

order reference

OADM 260I1101/S14C

connection diagram

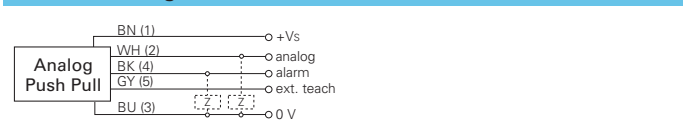

connectors

| | | |
|-----------|-------|-------------------------|
| ES 34CP2B | 5 pin | 2 m straight (shielded) |
| ES 34CP5B | 5 pin | 5 m straight (shielded) |

additional cable connectors and field wireable connectors, see accessories

accessories

| | |
|--------------|----------|
| mounting kit | 11010227 |
|--------------|----------|

for details, see accessories section

laser warning



LASER RADIATION
DO NOT STARE INTO BEAM
 Wavelength: 620...680nm
 Max. av. Output: < 1mW
 IEC 60825-1, Ed. 2, 2007
CLASS 2 LASER PRODUCT



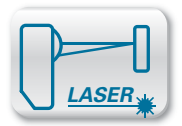

Complies with 21 CFR 1040.10 and 1040.11 except for deviations pursuant to laser notice No. 50, dated June 24, 2007

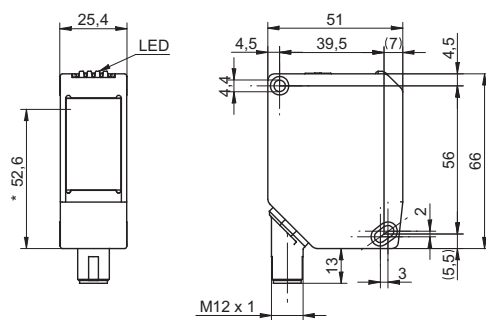

dimension drawing



* emitter axis

| product family | OBDM 12 | OBDM 12 | OBDM 12 | OBDM 12 | OBDM 12 |
|---------------------|---|---|---|---|---|
| |  |  |  |  |  |
| type | step analysis | min./max. analysis | tolerance analysis | window analysis | 2-point comparison |
| width / diameter | 12,4 mm | 12,4 mm | 12,4 mm | 12,4 mm | 12,4 mm |
| sensing distance Tw | 16 ... 120 mm | 16 ... 120 mm | 16 ... 120 mm | 16 ... 120 mm | 16 ... 120 mm |
| response time | < 5 ms | < 1 ms | < 1 ms | < 1 ms | < 1 ms |
| NPN | ■ | ■ | ■ | ■ | ■ |
| PNP | ■ | ■ | ■ | ■ | ■ |
| connection types | connector | connector | connector | connector | connector |
| housing material | metal | metal | metal | metal | metal |
| | | | | | |
| page | 83 | 84 | 85 | 86 | 87 |



General information

The range of difference sensors opens new perspectives in the field of sensing. The patented functions provide the user with new, innovative solutions in the detection of objects, monitoring of tolerances or the comparison of object sizes and object positions. With the fine laser beam and the high insensitivity of the sensor to colors, objects are accurately detected. Five different sensors with different functions are available according to the application.

Difference sensors with:

- Step analysis
- Window analysis
- Tolerance analysis
- Min./max. analysis
- 2-point comparisons

Characteristics and advantages

Difference evaluation

Distance measuring sensors with integrated logic for distance difference evaluation. Complex evaluation by the connected controller is no longer necessary, saving time and costs.

Nominal difference teachable

With the standardized Teach-in process of Baumer, the nominal difference can be quickly and easily programmed.

Switching output

The comparison of the actual and nominal difference is made internally by the sensors and is issued at the switching output as a simply assessed pass/fail signal.

Applications and functions

Difference sensors with step analysis

In step analysis, objects are detected by their height difference (stage) and reported in the form of a digital output signal.

The sensor evaluates the positive or negative height difference within a specified time window of max. 5 ms. If the height difference is greater than 50 % of the taught-in value, an impulse of at least 10 ms is issued at the output. When the value is less than 50 %, the sensor switches back to the OFF state. If height differences are smaller than 50 % of the taught value within the time window (e.g. fluctuation of the conveyor belt), the sensor remains in the OFF state.

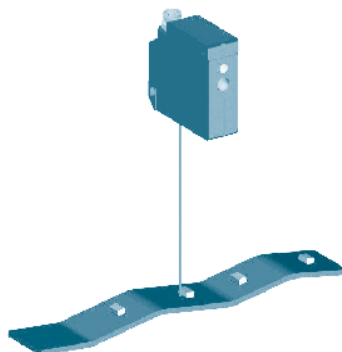

- The stage / edge from which the objects are detected can be adjusted (minimum object height 0,2 mm)
- Defined output impulse of 10 ms (can also be read by a normal PLC)
- Detection of objects on a fluctuating conveyor belt
- Detection of stages or edges
- Positioning of objects by an edge, regardless of the distance



Applications and functions

Difference sensors with min./max. analysis

With min./max. analysis, objects can be inspected and monitored according to their scanned contour or shape. The scanning of the objects is activated by an external control signal. At the end of a detection sequence, the measured values are evaluated and the difference between the minimum and maximum values is determined. If the difference exceeds a nominal difference previously taught into the sensor, this is reported in the form of an ON signal. This signal remains active until a new detection sequence is started. When this starts, the output returns to the OFF state. If the difference is smaller than the nominal difference, the output remains in the OFF state.



- Difference is detected regardless of the distance
- Start and stop of the measuring cycle can be determined independently
- Easily evaluated pass/fail signal
- Round true running or knock of wheels / discs can be checked regardless of the distance
- Deformation of plastic parts after cooling can be checked

Difference sensors with tolerance analysis

The dimensional tolerance of objects can be determined by tolerance analysis. In the continuous detection of object distances, all measured values are checked to determine if it is between the specified maximum and minimum tolerances. In the case of if being between, an ON signal is issued at the output. If the distance remains within the tolerance range, the sensor remains in the OFF state.

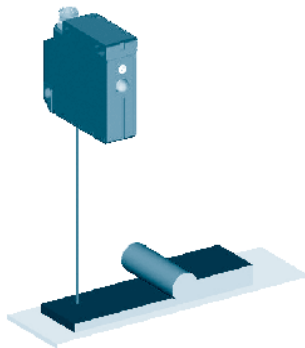

- Sensor form of a caliper gauge
- Simple monitoring of a distance with a tolerance range (pass/fail information)
- Tolerance range and nominal distance can be taught in separately
- Material thickness checking after a roller mill
- Material thickness checking for extruders



Applications and functions

Difference sensors with window analysis

With window analysis, objects can be classified by a specified switching window.

For this purpose, the switching window is specified in a simple Teach-in procedure with upper and lower limits. If an object is outside the defined limits, this is reported at the switching output.

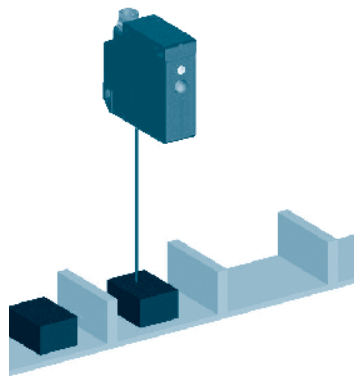

- Foreground and background suppression in a single sensor
- Positions can be taught in separately
- Smallest window 0,45 mm
- Interfering objects in the foreground and background can be suppressed
- Objects can be detected on a segmented conveyor belt

Difference sensors with 2-point comparison

In a 2-point comparison, two distances detected at two specifically chosen times are measured and compared.

The choice of the time is made using a sync signal. The first distance is measured at the rising flank of the signal and the second distance at the falling flank of the signal. After the second distance was measured, the sensor evaluates the difference between the two distances and compares this with a previously taught-in maximum permissible deviation. If this difference is exceeded, the output switches to the ON state.

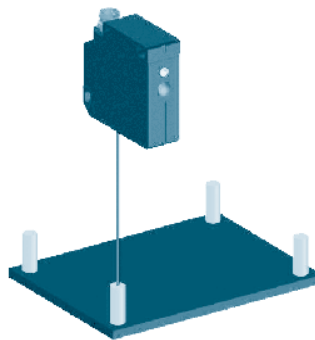

- Object heights can be compared regardless of the distance
- Deviation can be taught in (min. 0,3 mm)
- Measuring time can be determined separately by an external signal
- Checking the pressing depth of pins
- Comparison of the distances/heights of objects with a reference value



Mounting and adjustment

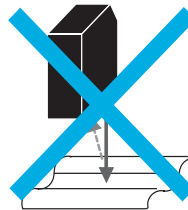
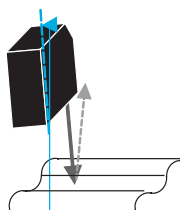

The direct reflection from glossy or reflective objects must not impinge on the receiver. This can be avoided by slightly tilting the sensor.

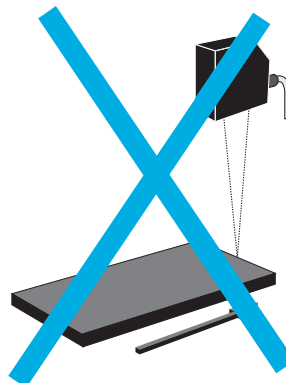
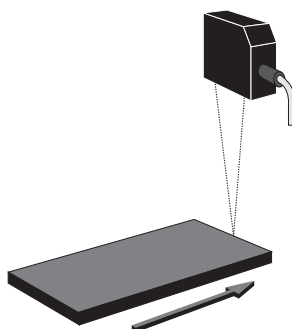

For optimum measurement results, the sensor must be installed at right angles to the movement of the object.

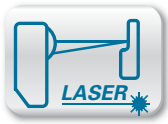

Tw = 16 ... 120 mm



- detection of edges
- reference steps adjustable
- min. output pulse 10 ms

general data

| | |
|---------------------|------------------------|
| type | step analysis |
| sensing distance Tw | 16 ... 120 mm |
| Teach-in range min. | > 0,2 mm |
| adjustment | Teach-in |
| power on indication | LED green |
| output indicator | LED red |
| light source | pulsed red laser diode |
| laser class | 2 |
| wave length | 650 nm |
| beam diameter | 0,5 ... 0,2 mm |

electrical data

| | |
|------------------------------------|----------------|
| response time | < 5 ms |
| voltage supply range +Vs | 12 ... 28 VDC |
| current consumption max. (no load) | 80 mA |
| current consumption typ. | 40 mA |
| output current | < 100 mA |
| output pulse length | 10 ms |
| voltage drop Vd | < 2,8 VDC |
| reverse polarity protection | yes, Vs to GND |
| short circuit protection | yes |

mechanical data

| | |
|------------------|--------------------|
| width / diameter | 12,4 mm |
| height / length | 37 mm |
| depth | 34,5 mm |
| type | rectangular |
| front (optics) | glass |
| housing material | die-cast zinc |
| connection types | connector M8 4 pin |

ambient conditions

| | |
|-----------------------|--------------|
| operating temperature | 0 ... +50 °C |
| protection class | IP 67 |

connectors

| | | |
|--|-------|--------------|
| ESG 32AH0200 | 4 pin | 2 m straight |
| ESW 31AH0200 | 4 pin | 2 m angular |
| additional cable connectors and field wireable connectors, see accessories | | |

accessories

| | |
|--------------------------------------|----------|
| SENSOFIX mounting kit | 10150328 |
| mounting bracket | 10113873 |
| for details, see accessories section | |

order reference output circuit

| | |
|-------------------|-----|
| OBDM 12N6910/S35A | NPN |
| OBDM 12P6910/S35A | PNP |

dimension drawing

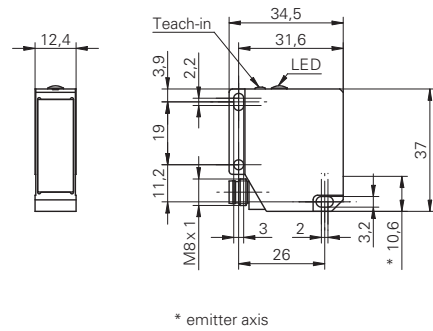

connection diagrams

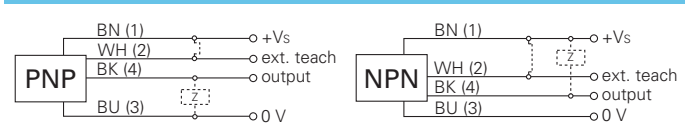

min. detectable difference

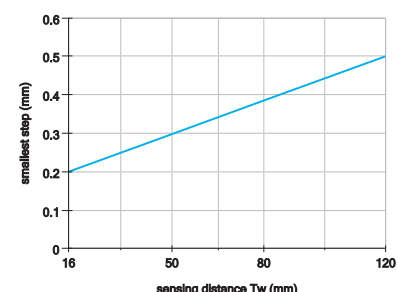

laser warning



Complies with 21 CFR 1040.10 and 1040.11 except for deviations pursuant to laser notice No. 50, dated June 24, 2007

OBDM 12 Tw = 16 ... 120 mm Difference sensors

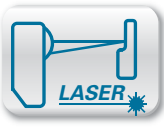

Tw = 16 ... 120 mm



- analysis of distance differences (min./max.)
- max. difference tolerance adjustable
- measuring time selectable

general data

| | |
|---------------------|------------------------|
| type | min./max. analysis |
| sensing distance Tw | 16 ... 120 mm |
| Teach-in range min. | > 0,3 mm |
| adjustment | Teach-in |
| power on indication | LED green |
| output indicator | LED red |
| light source | pulsed red laser diode |
| laser class | 2 |
| wave length | 650 nm |
| beam diameter | 0,5 ... 0,2 mm |

electrical data

| | |
|------------------------------------|----------------|
| response time | < 1 ms |
| voltage supply range +Vs | 12 ... 28 VDC |
| current consumption max. (no load) | 80 mA |
| current consumption typ. | 40 mA |
| output current | < 100 mA |
| voltage drop Vd | < 2,8 VDC |
| reverse polarity protection | yes, Vs to GND |
| short circuit protection | yes |

mechanical data

| | |
|------------------|--------------------|
| width / diameter | 12,4 mm |
| height / length | 37 mm |
| depth | 34,5 mm |
| type | rectangular |
| front (optics) | glass |
| housing material | die-cast zinc |
| connection types | connector M8 4 pin |

ambient conditions

| | |
|-----------------------|--------------|
| operating temperature | 0 ... +50 °C |
| protection class | IP 67 |

connectors

| | | |
|--------------|-------|--------------|
| ESG 32AH0200 | 4 pin | 2 m straight |
| ESW 31AH0200 | 4 pin | 2 m angular |

additional cable connectors and field wireable connectors, see accessories

accessories

| | |
|------------------------|----------|
| SENOSIFIX mounting kit | 10150328 |
| mounting bracket | 10113873 |

for details, see accessories section

order reference output circuit

| | |
|-------------------|-----|
| OBDM 12N6920/S35A | NPN |
| OBDM 12P6920/S35A | PNP |

dimension drawing

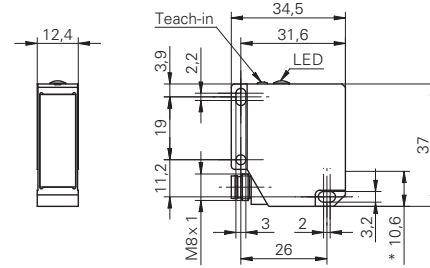

* emitter axis

connection diagrams

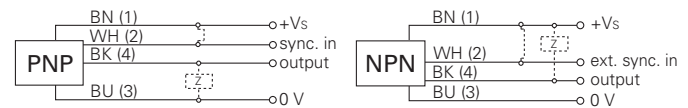

min. detectable difference

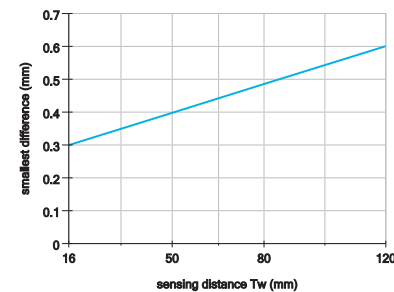

laser warning



**LASER RADIATION
DO NOT STARE INTO BEAM**
Wavelength: 620...680nm
Max. av. Output: < 1mW
IEC 60825-1, Ed. 2, 2007
CLASS 2 LASER PRODUCT

Complies with 21 CFR 1040.10 and 1040.11 except for deviations pursuant to laser notice No. 50, dated June 24, 2007

OBDM 12 Tw = 16 ... 120 mm

Difference sensors

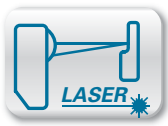

Tw = 16 ... 120 mm



- distance monitoring within a tolerance band
- nominal distance
- adjustable tolerance band

general data

| | |
|---------------------|------------------------|
| type | tolerance analysis |
| sensing distance Tw | 16 ... 120 mm |
| Teach-in range min. | > 0,4 mm |
| adjustment | Teach-in |
| power on indication | LED green |
| output indicator | LED red |
| light source | pulsed red laser diode |
| laser class | 2 |
| wave length | 650 nm |
| beam diameter | 0,5 ... 0,2 mm |

electrical data

| | |
|------------------------------------|----------------|
| response time | < 1 ms |
| voltage supply range +Vs | 12 ... 28 VDC |
| current consumption max. (no load) | 80 mA |
| current consumption typ. | 40 mA |
| output current | < 100 mA |
| voltage drop Vd | < 2,8 VDC |
| reverse polarity protection | yes, Vs to GND |
| short circuit protection | yes |

mechanical data

| | |
|------------------|--------------------|
| width / diameter | 12,4 mm |
| height / length | 37 mm |
| depth | 34,5 mm |
| type | rectangular |
| front (optics) | glass |
| housing material | die-cast zinc |
| connection types | connector M8 4 pin |

ambient conditions

| | |
|-----------------------|--------------|
| operating temperature | 0 ... +50 °C |
| protection class | IP 67 |

connectors

| | | |
|--------------|-------|--------------|
| ESG 32AH0200 | 4 pin | 2 m straight |
| ESW 31AH0200 | 4 pin | 2 m angular |

additional cable connectors and field wireable connectors, see accessories

accessories

| | |
|-----------------------|----------|
| SENSOFIX mounting kit | 10150328 |
| mounting bracket | 10113873 |

for details, see accessories section

dimension drawing

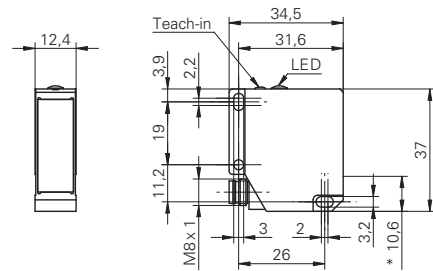

* emitter axis

connection diagrams

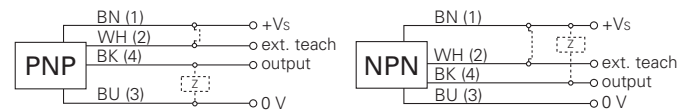

min. detectable difference

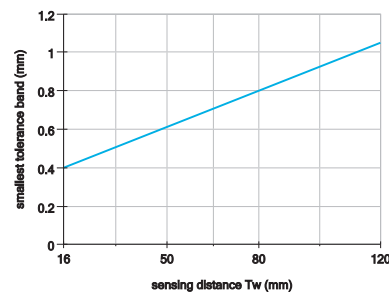

laser warning

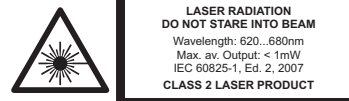

Complies with 21 CFR 1040.10 and 1040.11 except for deviations pursuant to laser notice No. 50, dated June 24, 2007

order reference **output circuit**

| | |
|-------------------|-----|
| OBDM 12N6930/S35A | NPN |
| OBDM 12P6930/S35A | PNP |

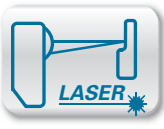

Tw = 16 ... 120 mm



- range switch (foreground / background suppression)
- adjustable window

general data

| | |
|---------------------|------------------------|
| type | window analysis |
| sensing distance Tw | 16 ... 120 mm |
| Teach-in range min. | > 0,4 mm |
| adjustment | Teach-in |
| power on indication | LED green |
| output indicator | LED red |
| light source | pulsed red laser diode |
| laser class | 2 |
| wave length | 650 nm |
| beam diameter | 0,5 ... 0,2 mm |

electrical data

| | |
|------------------------------------|----------------|
| response time | < 1 ms |
| voltage supply range +Vs | 12 ... 28 VDC |
| current consumption max. (no load) | 80 mA |
| current consumption typ. | 40 mA |
| output current | < 100 mA |
| voltage drop Vd | < 2,8 VDC |
| reverse polarity protection | yes, Vs to GND |
| short circuit protection | yes |

mechanical data

| | |
|------------------|--------------------|
| width / diameter | 12,4 mm |
| height / length | 37 mm |
| depth | 34,5 mm |
| type | rectangular |
| front (optics) | glass |
| housing material | die-cast zinc |
| connection types | connector M8 4 pin |

ambient conditions

| | |
|-----------------------|--------------|
| operating temperature | 0 ... +50 °C |
| protection class | IP 67 |

connectors

| | | |
|--------------|-------|--------------|
| ESG 32AH0200 | 4 pin | 2 m straight |
| ESW 31AH0200 | 4 pin | 2 m angular |

additional cable connectors and field wireable connectors, see accessories

accessories

| | |
|-----------------------|----------|
| SENsoFIX mounting kit | 10150328 |
| mounting bracket | 10113873 |

for details, see accessories section

order reference output circuit

| | |
|-------------------|-----|
| OBDM 12N6940/S35A | NPN |
| OBDM 12P6940/S35A | PNP |

dimension drawing

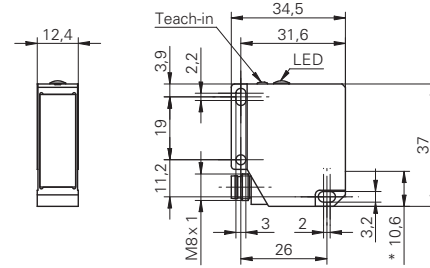

* emitter axis

connection diagrams

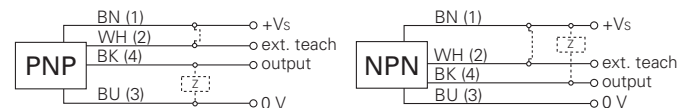

min. detectable difference

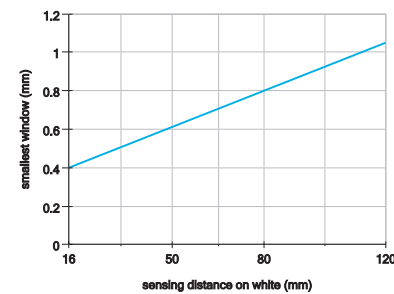

laser warning

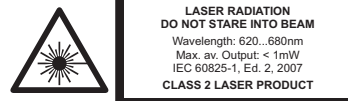

Complies with 21 CFR 1040.10 and 1040.11 except for deviations pursuant to laser notice No. 50, dated June 24, 2007

OBDM 12 Tw = 16 ... 120 mm

Difference sensors

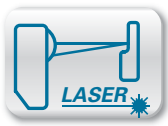

Tw = 16 ... 120 mm

- comparison of two distances
- max. tolerance adjustable
- specific measuring moment selectable



general data

| | |
|---------------------|------------------------|
| type | 2-point comparison |
| sensing distance Tw | 16 ... 120 mm |
| Teach-in range min. | > 0,3 mm |
| adjustment | Teach-in |
| power on indication | LED green |
| output indicator | LED red |
| light source | pulsed red laser diode |
| laser class | 2 |
| wave length | 650 nm |
| beam diameter | 0,5 ... 0,2 mm |

electrical data

| | |
|------------------------------------|----------------|
| response time | < 1 ms |
| voltage supply range +Vs | 12 ... 28 VDC |
| current consumption max. (no load) | 80 mA |
| current consumption typ. | 40 mA |
| output current | < 100 mA |
| voltage drop Vd | < 2,8 VDC |
| reverse polarity protection | yes, Vs to GND |
| short circuit protection | yes |

mechanical data

| | |
|------------------|--------------------|
| width / diameter | 12,4 mm |
| height / length | 37 mm |
| depth | 34,5 mm |
| type | rectangular |
| front (optics) | glass |
| housing material | die-cast zinc |
| connection types | connector M8 4 pin |

ambient conditions

| | |
|-----------------------|--------------|
| operating temperature | 0 ... +50 °C |
| protection class | IP 67 |

connectors

| | | |
|--|-------|--------------|
| ESG 32AH0200 | 4 pin | 2 m straight |
| ESW 31AH0200 | 4 pin | 2 m angular |
| additional cable connectors and field wireable connectors, see accessories | | |

accessories

| | |
|-----------------------|----------|
| SENSOFIX mounting kit | 10150328 |
| mounting bracket | 10113873 |

for details, see accessories section

dimension drawing

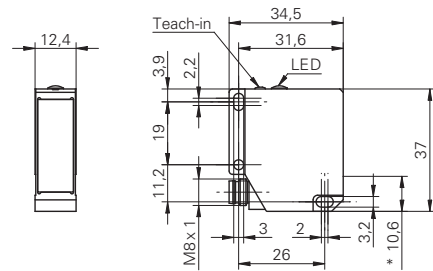

* emitter axis

connection diagrams

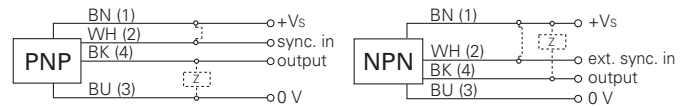

min. detectable difference

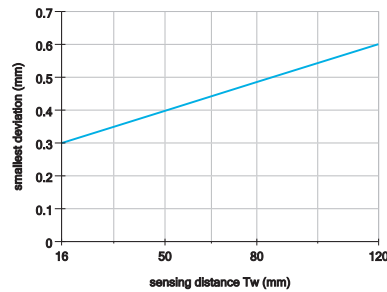

laser warning



**LASER RADIATION
DO NOT STARE INTO BEAM**
Wavelength: 620...680nm
Max. av. Output: < 1mW
IEC 60825-1, Ed. 2, 2007
CLASS 2 LASER PRODUCT







Complies with 21 CFR 1040.10 and 1040.11 except for deviations pursuant to laser notice No. 50, dated June 24, 2007

order reference

output circuit









| | |
|-------------------|-----|
| OBDM 12N6950/S35A | NPN |
| OBDM 12P6950/S35A | PNP |

red light LED version



| product family | FHDK 04 | FHCK 07 | FHDK 07 | FHDK 10 | FHDK 10 | FHDK 10 | FHDK 10 |
|------------------------------|---|---|--------------|---|---|---|---|
| |  |  | |  |  |  |  |
| version | | MINOS | MINOS | | | point source LED | line beam |
| width / diameter | 4 mm | 8 mm | 8 mm | 10,4 mm | 10,4 mm | 10,4 mm | 10,4 mm |
| sensing distance Tw | 30 mm ±2 mm 50 mm ±3 mm | 10 ... 60 mm | 10 ... 60 mm | 30 mm ±2 mm 50 mm ±3 mm 80 mm ±8 mm | 20 ... 120 mm | 25 ... 120 mm | 20 ... 80 mm |
| response time / release time | < 0,5 ms | < 0,5 ms | < 0,5 ms | < 1 ms | < 1 ms | < 1 ms | < 1 ms |
| sensing distance adjustment | | Teach-in | Teach-in | | mechanical, 5 turn | mechanical, 5 turn | mechanical, 5 turn |
| push-pull | ■ | | | ■ | | | |
| NPN | | ■ | ■ | | ■ | ■ | ■ |
| PNP | | ■ | ■ | | ■ | ■ | ■ |
| cable | ■ | ■ | ■ | ■ | ■ | ■ | ■ |
| flylead connector | ■ | ■ | ■ | | ■ | | |
| connector | | | | ■ | ■ | ■ | ■ |
| housing material | plastic | plastic | plastic | plastic | plastic | plastic | plastic |
| | | | | | | | |
| page | 94 | 96 | 98 | 100 | 102 | 104 | 106 |



Overview

Diffuse sensors with background suppression

| FHDK 10 | FHDM 12 | FHDK 14 | FHDK 14 | FHDH 14 | FHDR 14 | FHDM 16 | FHDK 20 |
|---|---|---|---|---|---|---|---|
|  |  |  |  |  |  |  |  |
| | | | | | | | |
| for glass detection | | | | | | | |
| 10,4 mm | 12,4 mm | 14,8 mm | 14,8 mm | 19,6 mm | 19,6 mm | 15,4 mm | 20 mm |
| 10 ... 30 mm | 15 ... 300 mm | 20 ... 350 mm 30 ... 500 mm | 40 ... 200 mm | 50 ... 400 mm | 50 ... 400 mm | 20 ... 450 mm 20 ... 600 mm | 30 ... 200 mm |
| < 1 ms | < 1 ms | < 1 ms < 5 ms | < 0,5 ms | < 1,8 ms | < 1,8 ms | < 1 ms < 5 ms | < 0,5 ms |
| mechanical, 5 turn | mechanical, 5 turn | mechanical, 10 turn | Teach-in | Teach-in /IO-Link | Teach-in /IO-Link | mechanical, 5 turn | Teach-in |
| ■ | ■ | ■ | ■ | ■ | ■ | ■ | ■ |
| ■ | ■ | ■ | ■ | | | ■ | ■ |
| | ■ | ■ | ■ | ■ | | ■ | |
| | | | | ■ | | | |
| ■ | ■ | ■ | ■ | | ■ | ■ | ■ |
| plastic | metal | plastic | plastic | metal | metal | metal | plastic |
| | | | | IO-Link | IO-Link | | |
| | | | | | | | |
| 108 | 114 | 120 | 122 | 124 | 126 | 130 | 136 |

laser version

| product family | OHDK 10 | OHDK 10 | OHDM 12 | OHDM 13 | OHDK 14 | OHDM 16 | OHDM 16 |
|------------------------------|---|---|---|---|---|---|---|
| |  |  |  |  |  |  |  |
| version | | line beam | | | | | wafer mapping sensor |
| width / diameter | 10,4 mm | 10,4 mm | 12,4 mm | 13,4 mm | 14,8 mm | 15,4 mm | 15,4 mm |
| sensing distance Tw | 22 ... 130 mm | 22 ... 130 mm | 17 ... 120 mm | 50 ... 550 mm | 20 ... 350 mm | 25 ... 300 mm | 123 ... 143 mm |
| response time / release time | < 0,25 ms | < 0,25 ms | | | < 0,5 ms | < 0,1 ms < 0,6 ms | < 5 ms |
| response time | | | < 1 ms | < 5 ms | | | |
| release time | | | < 2,7 ms | < 15 ms | | | |
| sensing distance adjustment | mechanical, 5 turn | mechanical, 5 turn | Teach-in | Teach-in | mechanical, 9 turn | mechanical, 8 turn | no |
| push-pull | | | | | | | |
| NPN | ■ | ■ | ■ | ■ | ■ | ■ | ■ |
| PNP | ■ | ■ | ■ | ■ | ■ | ■ | ■ |
| cable | ■ | | | | ■ | ■ | ■ |
| connector | ■ | ■ | ■ | ■ | ■ | ■ | |
| housing material | plastic | plastic | metal | metal | plastic | metal | metal |
| page | 110 | 112 | 116 | 118 | 128 | 132 | 134 |

| OHDM 20 | OHDK 25 | OHDK 25 |
|---|---|---|
|  |  |  |
| 20,6 mm | 23,4 mm | 23,4 mm |
| 210 ... 1500 mm | 100 ... 1000 mm | 100 ... 2000 mm |
| < 6 ms | < 6 ms | < 10 ms |
| < 18 ms | | |
| Teach-in | Teach-in | Teach-in |
| | ■ | ■ |
| ■ | | |
| ■ | ■ | ■ |
| metal | plastic | plastic |
| 138 | 140 | 142 |



General information

By using the triangulation principle, diffuse sensors with background suppression not only measure the light intensity reflected by the target, but also determine the distance of the object from the sensor. In this way, objects with the minimum size of the light beam located within the adjustable sensing distance can be detected regardless of their color and surface.

The diffuse sensors with background suppression and laser light source were developed specifically for applications in which exact positioning is important. With the precisely focused beam, even very small objects such as the wires of a resistor or threads can be clearly detected or counted.

Applications

- Detection of boxes, metal and plastic parts lying on a base such as a conveyor belt, table or transport trolley from above
- Detection of bulk materials or other non-transparent materials in a container
- Counting of different-colored objects such as plastic bottles or printed packages
- Reliable presence monitoring of assembly parts, even with objects moving in the background

Characteristics and advantages

Adjustable sensing distance

The switching point can be adjusted accurately between the object and the interfering background using a set screw or Teach-in method

Largely independent of color

The sensing distance remains constant even if the color of the objects changes. Readjustment is therefore unnecessary. Objects changing in the background also have no effect.

Small spot size

Laser sensors can detect objects with a size of just 0,1 mm. Sensors with pinpoint diodes have a spot of only 2 mm diameter at the focus.

Red light emitters

Visible red light permits simple adjustment of the sensor to small objects by eye.

Short response time

Small, quickly moving objects are reliably detected due to the short response time.

Technology and operation

The sensors are based on the triangulation principle. Only the angle of the light reflected back from the object determines the distance at which the sensor responds. The amount of reflected light is far less important.

The schematic sketch below shows that receiver R1 receives the light reflected back from the object T1 (acute angle of incidence) and receiver R2 the light reflected back from the background (shallow angle of incidence). The transition from R1 to R2 determines the sensing distance.

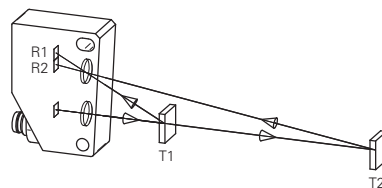



Mounting and adjustment

The diffuse sensor must be aimed at the object. The sensing distance must be set to a distance between the target and the background. The background must be located behind the adjusted sensing distance by at least the distance of the sensing distance reduction of the sensor to black.

For diffuse sensors with background suppression, the sensing range diagram is specified for the optimum adjustment. This indicates the sensing range reduction as a function of the sensing range to white for different degrees of remission. This means the distance by which the sensing distance to black or gray is reduced in comparison with white. When the adjusted sensing range to white is entered on the X axis of the diagram, the reduction of the sensing distance to black or gray can be read off on the Y axis. The sensing distance reduction also indicates the minimum distance a black or gray object must be separated from a white background.

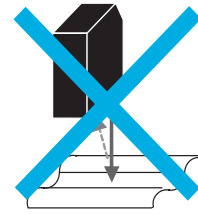
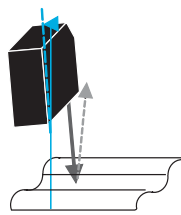
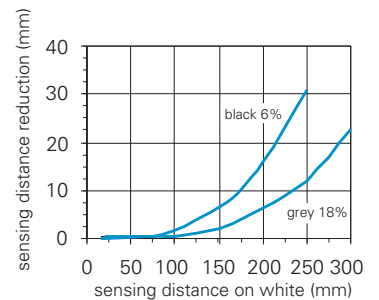

The direct reflection from glossy or reflective objects must not impinge on the receiver. This can be avoided by slightly tilting the sensor.

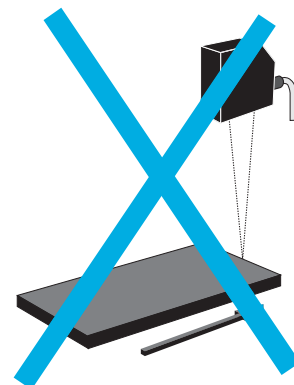
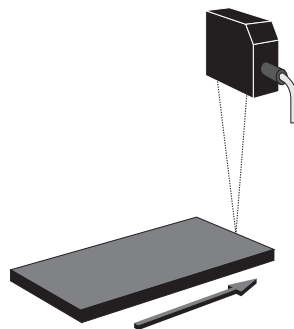

It should be ensured that the object to be detected approaches the active area of the sensor from the side, which avoids malfunctions caused by deflection of the light beam at edges.

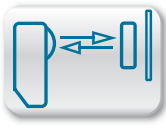

Tw = 50 mm



- compact housing
- small beam diameter
- push-pull output

general data

| | |
|-------------------------------------|--------------------------|
| type | background suppression |
| light source | pulsed point source LED |
| alignment / soiled lens indicator | flashing light indicator |
| light indicator | LED yellow |
| wave length | 660 nm |
| beam diameter | 2 mm |
| suppression of reciprocal influence | yes |

electrical data

| | |
|------------------------------------|------------------|
| response time / release time | < 0,5 ms |
| voltage supply range +Vs | 11 ... 30 VDC |
| current consumption max. (no load) | 30 mA |
| current consumption typ. | 20 mA |
| voltage drop Vd | < 2 VDC |
| output circuit | push-pull |
| output current | < 50 mA |
| short circuit protection | yes |
| reverse polarity protection | yes, supply only |

mechanical data

| | |
|------------------|---------------|
| width / diameter | 4 mm |
| height / length | 44,8 mm |
| depth | 6,2 mm |
| type | rectangular |
| housing material | plastic (ASA) |
| front (optics) | PMMA |

ambient conditions

| | |
|-----------------------|----------------|
| operating temperature | -10 ... +50 °C |
| protection class | IP 65 |

connection diagrams

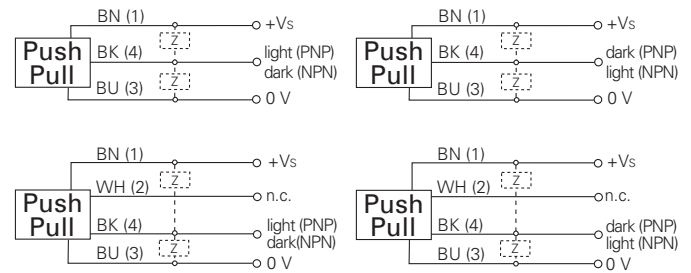

connectors

| | | |
|--------------|-------|--------------|
| ESG 32AH0200 | 4 pin | 2 m straight |
| ESW 31AH0200 | 4 pin | 2 m angular |

additional cable connectors and field wireable connectors, see accessories

accessories

| | |
|------------------------------|----------|
| mounting brad | 10163196 |
| bracket for extrusion frames | 10163299 |

for details, see accessories section

| order reference | sensing distance Tw | connection types | output function |
|--------------------|---------------------|----------------------------|-----------------|
| FHDK 04G6101 | 30 mm ±2 mm | cable 3 pin, 2 m | light operate |
| FHDK 04G6101/KS35A | 30 mm ±2 mm | flylead connector M8 4 pin | light operate |
| FHDK 04G6102 | 50 mm ±3 mm | cable 3 pin, 2 m | light operate |
| FHDK 04G6102/KS35A | 50 mm ±3 mm | flylead connector M8 4 pin | light operate |
| FHDK 04G6111 | 30 mm ±2 mm | cable 3 pin, 2 m | dark operate |
| FHDK 04G6111/KS35A | 30 mm ±2 mm | flylead connector M8 4 pin | dark operate |
| FHDK 04G6112 | 50 mm ±3 mm | cable 3 pin, 2 m | dark operate |
| FHDK 04G6112/KS35A | 50 mm ±3 mm | flylead connector M8 4 pin | dark operate |

FHDK 04 Tw = 50 mm Diffuse sensors with background suppression

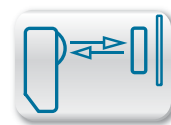

sensing distance diagrams

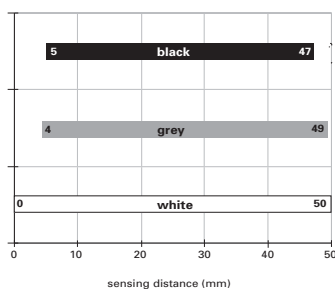
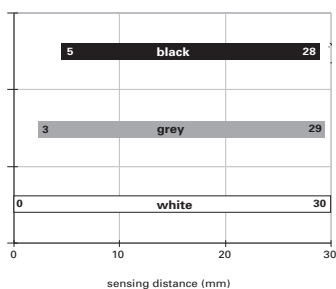

dimension drawings

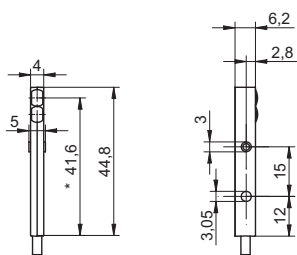

* emitter axis

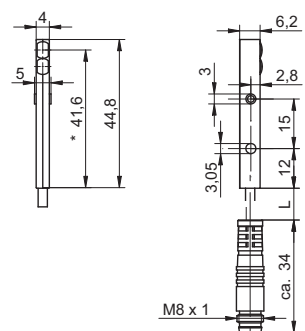

* emitter axis cable length L = 200 mm

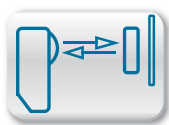

$T_w = 10 \dots 60 \text{ mm}$

- ultra compact housing
- sensing distance adjustable via Teach-in
- suppression of mutual optical interference

general data

| | |
|-------------------------------------|--------------------------|
| type | background suppression |
| light source | pulsed red LED |
| sensing distance T_w | 10 ... 60 mm |
| sensing range T_b (at T_w max.) | 2 ... 60 mm |
| sensing range T_b (at T_w min.) | 5 ... 10 mm |
| alignment / soiled lens indicator | flashing light indicator |
| light indicator | LED green |
| output indicator | LED yellow |
| sensing distance adjustment | Teach-in |
| wave length | 660 nm |
| suppression of reciprocal influence | yes |

electrical data

| | |
|------------------------------------|----------------------|
| response time / release time | < 0,5 ms |
| voltage supply range +Vs | 10 ... 30 VDC |
| current consumption max. (no load) | 25 mA |
| current consumption typ. | 20 mA |
| voltage drop V_d | < 1,8 VDC |
| output function | light / dark operate |
| output current | < 100 mA |
| short circuit protection | yes |
| reverse polarity protection | yes |

mechanical data

| | |
|------------------|--------------------------|
| width / diameter | 8 mm |
| height / length | 16,2 mm |
| depth | 10,8 mm |
| type | rectangular |
| housing material | plastic (PMMA, MABS, PA) |
| front (optics) | PMMA |

ambient conditions

| | |
|-----------------------|----------------|
| operating temperature | -20 ... +50 °C |
| protection class | IP 65 |

| order reference | connection types | output circuit |
|--------------------|----------------------------|----------------|
| FHCK 07N6901 | cable rear side, 2 m | NPN |
| FHCK 07N6901/KS35A | flylead connector M8 4 pin | NPN |
| FHCK 07P6901 | cable rear side, 2 m | PNP |
| FHCK 07P6901/KS35A | flylead connector M8 4 pin | PNP |



connection diagrams

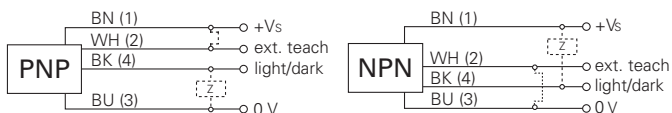

connectors

| | | |
|--------------|-------|--------------|
| ESG 32AH0200 | 4 pin | 2 m straight |
| ESW 31AH0200 | 4 pin | 2 m angular |

additional cable connectors and field wireable connectors, see accessories

accessories

| | |
|----------------------|----------|
| MINOFIX mounting kit | 10150844 |
|----------------------|----------|

for details, see accessories section

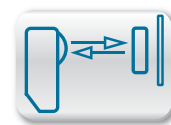

sensing distance diagram

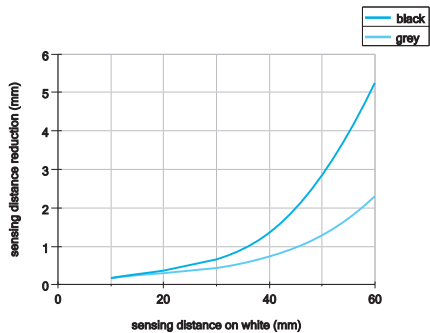

dimension drawings

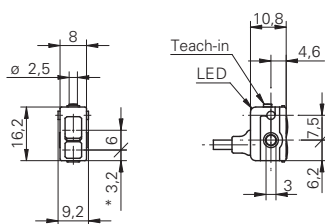

* emitter axis

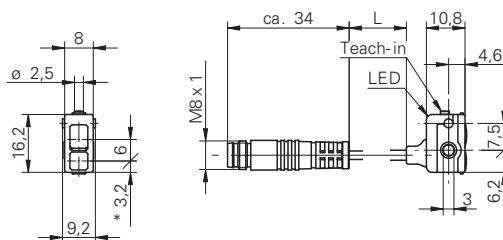

* emitter axis cable length L = 200 mm

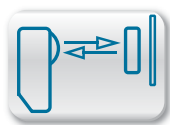

Tw = 10 ... 60 mm

- ultra compact housing
- sensing distance adjustable via Teach-in
- suppression of mutual optical interference

general data

| | |
|-------------------------------------|--------------------------|
| type | background suppression |
| light source | pulsed red LED |
| sensing distance Tw | 10 ... 60 mm |
| sensing range Tb (at Tw max.) | 2 ... 60 mm |
| sensing range Tb (at Tw min.) | 5 ... 10 mm |
| alignment / soiled lens indicator | flashing light indicator |
| light indicator | LED green |
| output indicator | LED yellow |
| sensing distance adjustment | Teach-in |
| wave length | 660 nm |
| suppression of reciprocal influence | yes |

electrical data

| | |
|------------------------------------|----------------------|
| response time / release time | < 0,5 ms |
| voltage supply range +Vs | 10 ... 30 VDC |
| current consumption max. (no load) | 25 mA |
| current consumption typ. | 20 mA |
| voltage drop Vd | < 1,8 VDC |
| output function | light / dark operate |
| output current | < 100 mA |
| short circuit protection | yes |
| reverse polarity protection | yes |

mechanical data

| | |
|------------------|--------------------------|
| width / diameter | 8 mm |
| height / length | 16,2 mm |
| depth | 10,8 mm |
| type | rectangular |
| housing material | plastic (PMMA, MABS, PA) |
| front (optics) | PMMA |

ambient conditions

| | |
|-----------------------|----------------|
| operating temperature | -20 ... +50 °C |
| protection class | IP 65 |

| order reference | connection types | output circuit |
|--------------------|----------------------------|----------------|
| FHDK 07N6901 | cable bottom side, 2 m | NPN |
| FHDK 07N6901/KS35A | flylead connector M8 4 pin | NPN |
| FHDK 07P6901 | cable bottom side, 2 m | PNP |
| FHDK 07P6901/KS35A | flylead connector M8 4 pin | PNP |



connection diagrams



connectors

| | | |
|--------------|-------|--------------|
| ESG 32AH0200 | 4 pin | 2 m straight |
| ESW 31AH0200 | 4 pin | 2 m angular |

additional cable connectors and field wireable connectors, see accessories

accessories

| | |
|----------------------|----------|
| MINOFIX mounting kit | 10150844 |
|----------------------|----------|

for details, see accessories section

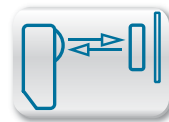

sensing distance diagram

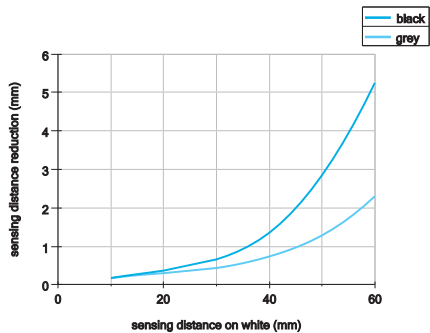

dimension drawings

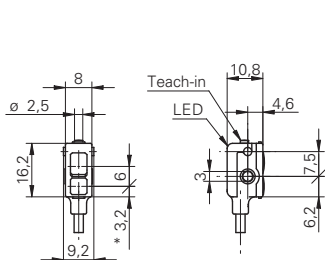

* emitter axis

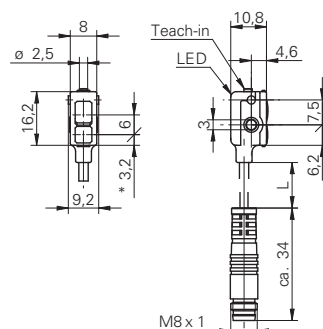

* emitter axis cable length L = 200 mm

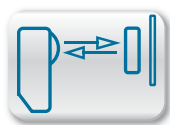

Tw = 80 mm

- compact housing
- fixed sensing distance
- push-pull output

general data

| | |
|-------------------------------------|--------------------------|
| type | background suppression |
| light source | pulsed red LED |
| alignment / soiled lens indicator | flashing light indicator |
| light indicator | LED yellow |
| wave length | 660 nm |
| suppression of reciprocal influence | yes |

electrical data

| | |
|------------------------------------|----------------------|
| response time / release time | < 1 ms |
| voltage supply range +Vs | 10 ... 30 VDC |
| current consumption max. (no load) | 25 mA |
| current consumption typ. | 18 mA |
| voltage drop Vd | < 1,8 VDC |
| output function | light / dark operate |
| output circuit | push-pull |
| output current | < 50 mA |
| short circuit protection | yes |
| reverse polarity protection | yes |

mechanical data

| | |
|------------------|---------------|
| width / diameter | 10,4 mm |
| height / length | 27 mm |
| depth | 14,7 mm |
| type | rectangular |
| housing material | plastic (ASA) |
| front (optics) | PMMA |

ambient conditions

| | |
|-----------------------|----------------|
| operating temperature | -25 ... +65 °C |
|-----------------------|----------------|

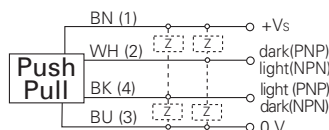
**connection diagram****connectors**

| | | |
|--------------|-------|--------------|
| ESG 32AH0200 | 4 pin | 2 m straight |
| ESW 31AH0200 | 4 pin | 2 m angular |

additional cable connectors and field wireable connectors, see accessories

accessories

| | |
|-----------------------------------|----------|
| <i>SENSOFIX</i> mounting kit | 10150326 |
| mounting bracket (cable type) | 10114501 |
| mounting bracket (connector type) | 10133792 |

for details, see accessories section

| order reference | sensing distance Tw | connection types | protection class |
|-------------------|---------------------|--------------------|------------------|
| FHDK 10G5120 | 30 mm ±2 mm | cable 4 pin, 2 m | IP 65 |
| FHDK 10G5120/S35A | 30 mm ±2 mm | connector M8 4 pin | IP 67 |
| FHDK 10G5121 | 50 mm ±3 mm | cable 4 pin, 2 m | IP 65 |
| FHDK 10G5121/S35A | 50 mm ±3 mm | connector M8 4 pin | IP 67 |
| FHDK 10G5122 | 80 mm ±8 mm | cable 4 pin, 2 m | IP 65 |
| FHDK 10G5122/S35A | 80 mm ±8 mm | connector M8 4 pin | IP 67 |

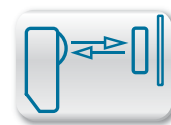

sensing distance diagrams

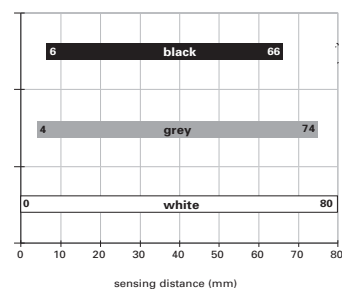
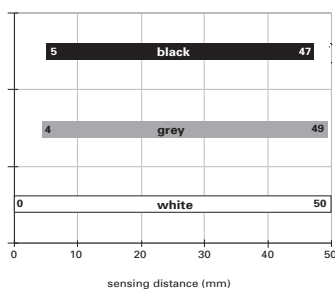
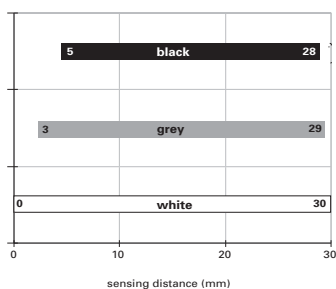

dimension drawings

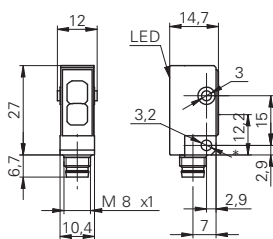

* emitter axis

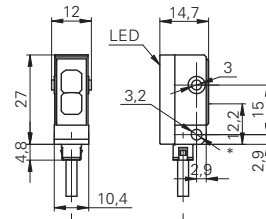

* emitter axis

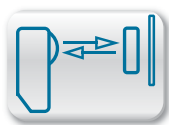

Tw = 20 ... 120 mm

- compact housing
- large sensing range
- sensing distance adjustable via potentiometer



general data

| | |
|-------------------------------------|--------------------------|
| type | background suppression |
| light source | pulsed red LED |
| sensing distance Tw | 20 ... 120 mm |
| sensing range Tb (at Tw max.) | 5 ... 120 mm |
| sensing range Tb (at Tw min.) | 5 ... 20 mm |
| alignment / soiled lens indicator | flashing light indicator |
| light indicator | LED yellow |
| sensing distance adjustment | mechanical, 5 turn |
| wave length | 660 nm |
| beam diameter | 4 mm |
| suppression of reciprocal influence | yes |

electrical data

| | |
|------------------------------------|---------------|
| response time / release time | < 1 ms |
| voltage supply range +Vs | 10 ... 30 VDC |
| current consumption max. (no load) | 30 mA |
| current consumption typ. | 20 mA |
| voltage drop Vd | < 1,8 VDC |
| output current | < 100 mA |
| short circuit protection | yes |
| reverse polarity protection | yes |

mechanical data

| | |
|------------------|---------------|
| width / diameter | 10,4 mm |
| height / length | 27 mm |
| depth | 14 mm |
| type | rectangular |
| housing material | plastic (ASA) |
| front (optics) | PMMA |

ambient conditions

| | |
|-----------------------|----------------|
| operating temperature | -25 ... +65 °C |
|-----------------------|----------------|

connection diagrams

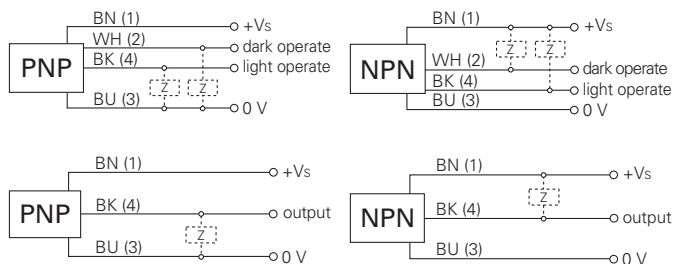

connectors

| | | |
|--------------|-------|--------------|
| ESG 32SH0200 | 3 pin | 2 m straight |
| ESW 31SH0200 | 3 pin | 2 m angular |
| ESG 32AH0200 | 4 pin | 2 m straight |
| ESW 31AH0200 | 4 pin | 2 m angular |

additional cable connectors and field wireable connectors, see accessories

accessories

| | |
|-----------------------------------|----------|
| SENSOFIX mounting kit | 10150326 |
| mounting bracket (cable type) | 10114501 |
| mounting bracket (connector type) | 10133792 |

for details, see accessories section

| order reference | connection types | output circuit | output function | protection class |
|-------------------|----------------------------|----------------|----------------------|------------------|
| FHDK 10N1101/KS35 | flylead connector M8 3 pin | NPN | light operate | IP 65 |
| FHDK 10N5101 | cable 4 pin, 2 m | NPN | light / dark operate | IP 65 |
| FHDK 10N5101/S35A | connector M8 4 pin | NPN | light / dark operate | IP 67 |
| FHDK 10P1101/KS35 | flylead connector M8 3 pin | PNP | light operate | IP 65 |
| FHDK 10P5101 | cable 4 pin, 2 m | PNP | light / dark operate | IP 65 |
| FHDK 10P5101/S35A | connector M8 4 pin | PNP | light / dark operate | IP 67 |

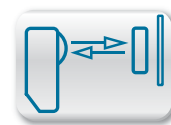

sensing distance diagram

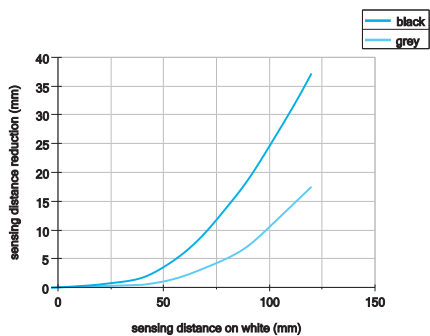

dimension drawings

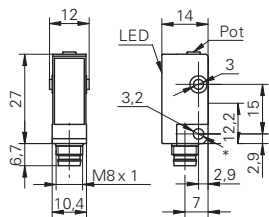

* emitter axis

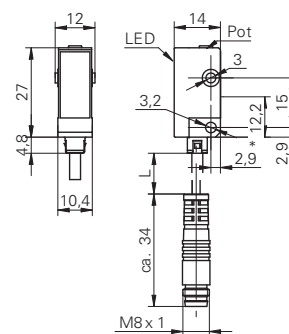

* emitter axis cable length L = 200 mm

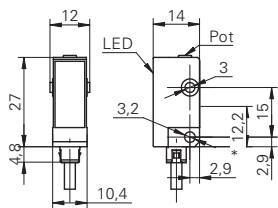

* emitter axis

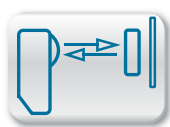

Tw = 20 ... 120 mm

- compact housing
- small beam diameter
- sensing distance adjustable via potentiometer

**general data**

| | |
|-------------------------------------|--------------------------|
| type | background suppression |
| version | point source LED |
| light source | pulsed point source LED |
| sensing distance Tw | 25 ... 120 mm |
| sensing range Tb (at Tw max.) | 5 ... 120 mm |
| sensing range Tb (at Tw min.) | 5 ... 25 mm |
| alignment / soiled lens indicator | flashing light indicator |
| light indicator | LED yellow |
| sensing distance adjustment | mechanical, 5 turn |
| distance to focus | 35 ... 45 mm |
| wave length | 660 nm |
| beam diameter | 2 mm at focus |
| suppression of reciprocal influence | yes |

electrical data

| | |
|------------------------------------|----------------------|
| response time / release time | < 1 ms |
| voltage supply range +Vs | 10 ... 30 VDC |
| current consumption max. (no load) | 30 mA |
| current consumption typ. | 20 mA |
| voltage drop Vd | < 1,8 VDC |
| output function | light / dark operate |
| output current | < 100 mA |
| short circuit protection | yes |
| reverse polarity protection | yes |

mechanical data

| | |
|------------------|---------------|
| width / diameter | 10,4 mm |
| height / length | 27 mm |
| depth | 14 mm |
| type | rectangular |
| housing material | plastic (ASA) |
| front (optics) | PMMA |

ambient conditions

| | |
|-----------------------|----------------|
| operating temperature | -25 ... +65 °C |
|-----------------------|----------------|

connection diagrams**connectors**

| | | |
|--------------|-------|--------------|
| ESG 32AH0200 | 4 pin | 2 m straight |
| ESW 31AH0200 | 4 pin | 2 m angular |

additional cable connectors and field wireable connectors, see accessories

accessories

| | |
|-----------------------------------|----------|
| <i>SENSOFIX</i> mounting kit | 10150326 |
| mounting bracket (cable type) | 10114501 |
| mounting bracket (connector type) | 10133792 |

for details, see accessories section

| order reference | connection types | output circuit | protection class |
|--------------------------|--------------------|----------------|------------------|
| FHDK 10N5110 | cable 4 pin, 2 m | NPN | IP 65 |
| FHDK 10N5110/S35A | connector M8 4 pin | NPN | IP 67 |
| FHDK 10P5110 | cable 4 pin, 2 m | PNP | IP 65 |
| FHDK 10P5110/S35A | connector M8 4 pin | PNP | IP 67 |

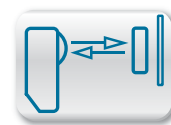

sensing distance diagram

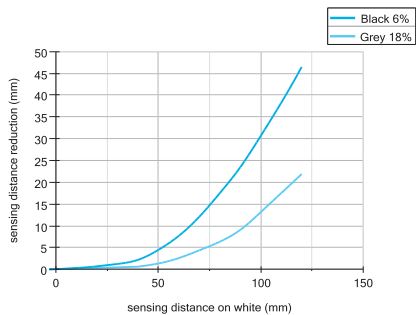

dimension drawings

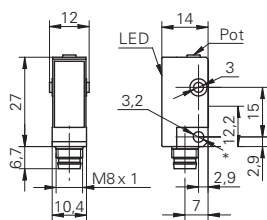

* emitter axis

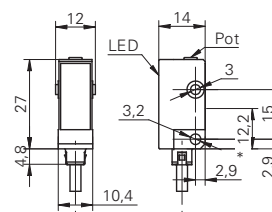

* emitter axis cable length L = 200 mm

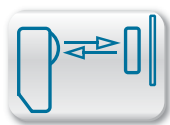

Tw = 20 ... 80 mm

- compact housing
- with line beam
- sensing distance adjustable via potentiometer

**general data**

| | |
|-------------------------------------|--------------------------|
| type | background suppression |
| version | line beam |
| light source | pulsed red LED |
| sensing distance Tw | 20 ... 80 mm |
| sensing range Tb (at Tw max.) | 5 ... 80 mm |
| sensing range Tb (at Tw min.) | 5 ... 20 mm |
| alignment / soiled lens indicator | flashing light indicator |
| light indicator | LED yellow |
| sensing distance adjustment | mechanical, 5 turn |
| wave length | 660 nm |
| suppression of reciprocal influence | yes |

electrical data

| | |
|------------------------------------|----------------------|
| response time / release time | < 1 ms |
| voltage supply range +Vs | 10 ... 30 VDC |
| current consumption max. (no load) | 30 mA |
| current consumption typ. | 20 mA |
| voltage drop Vd | < 1,8 VDC |
| output function | light / dark operate |
| output current | < 100 mA |
| short circuit protection | yes |
| reverse polarity protection | yes |

mechanical data

| | |
|------------------|---------------|
| width / diameter | 10,4 mm |
| height / length | 27 mm |
| depth | 14 mm |
| type | rectangular |
| housing material | plastic (ASA) |
| front (optics) | PMMA |

ambient conditions

| | |
|-----------------------|----------------|
| operating temperature | -25 ... +65 °C |
|-----------------------|----------------|

connection diagrams**connectors**

| | | |
|--------------|-------|--------------|
| ESG 32AH0200 | 4 pin | 2 m straight |
| ESW 31AH0200 | 4 pin | 2 m angular |

additional cable connectors and field wireable connectors, see accessories

accessories

| | |
|-----------------------------------|----------|
| <i>SENSOFIX</i> mounting kit | 10150326 |
| mounting bracket (cable type) | 10114501 |
| mounting bracket (connector type) | 10133792 |

for details, see accessories section

| order reference | connection types | output circuit | protection class |
|-------------------|--------------------|----------------|------------------|
| FHDK 10N5150 | cable 4 pin, 2 m | NPN | IP 65 |
| FHDK 10N5150/S35A | connector M8 4 pin | NPN | IP 67 |
| FHDK 10P5150 | cable 4 pin, 2 m | PNP | IP 65 |
| FHDK 10P5150/S35A | connector M8 4 pin | PNP | IP 67 |

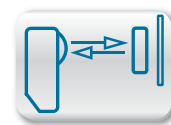

sensing distance diagram

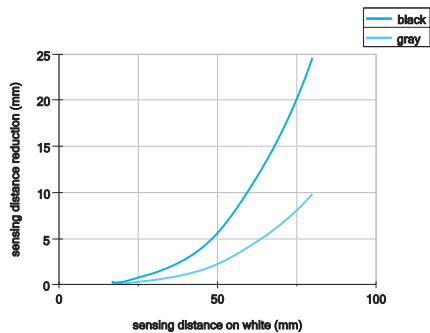

beam characteristic (typically)

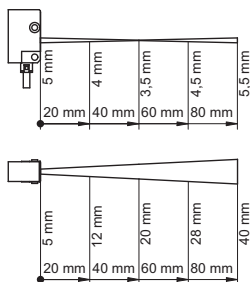

dimension drawings

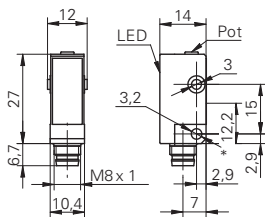

* emitter axis

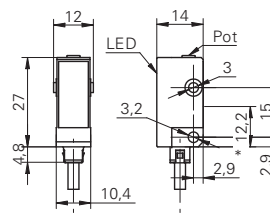

* emitter axis

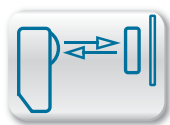

$T_w = 10 \dots 30 \text{ mm}$

- compact housing
- optimized for glass detection
- sensing distance adjustable via potentiometer

general data

| | |
|-------------------------------------|--------------------------|
| type | background suppression |
| version | for glass detection |
| light source | pulsed red LED |
| sensing distance T_w | 10 ... 30 mm |
| sensing range T_b (at T_w max.) | 3 ... 30 mm |
| alignment / soiled lens indicator | flashing light indicator |
| light indicator | LED yellow |
| sensing distance adjustment | mechanical, 5 turn |
| wave length | 660 nm |
| suppression of reciprocal influence | yes |

electrical data

| | |
|------------------------------------|----------------------|
| response time / release time | < 1 ms |
| voltage supply range +Vs | 10 ... 30 VDC |
| current consumption max. (no load) | 30 mA |
| current consumption typ. | 20 mA |
| voltage drop V_d | < 1,8 VDC |
| output function | light / dark operate |
| output current | < 100 mA |
| short circuit protection | yes |
| reverse polarity protection | yes |

mechanical data

| | |
|------------------|--------------------|
| width / diameter | 10,4 mm |
| height / length | 27 mm |
| depth | 14 mm |
| type | rectangular |
| housing material | plastic (ASA) |
| front (optics) | PMMA |
| connection types | connector M8 4 pin |

ambient conditions

| | |
|-----------------------|----------------|
| operating temperature | -25 ... +65 °C |
| protection class | IP 67 |

order reference

FHDK 10N5160/S35A
FHDK 10P5160/S35A

output circuit

NPN
PNP



connection diagrams



connectors

| | | |
|--------------|-------|--------------|
| ESG 32AH0200 | 4 pin | 2 m straight |
| ESW 31AH0200 | 4 pin | 2 m angular |

additional cable connectors and field wireable connectors, see accessories

accessories

| | |
|-----------------------|----------|
| SENSOFIX mounting kit | 10150326 |
| mounting bracket | 10133792 |

for details, see accessories section

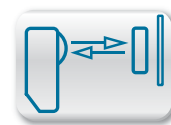

sensing distance diagrams

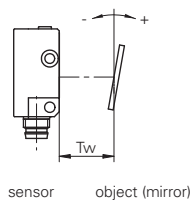
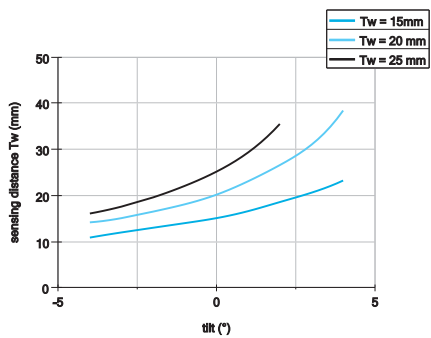

dimension drawing

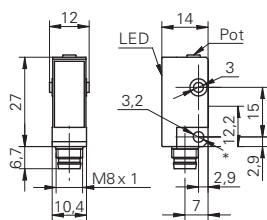

* emitter axis

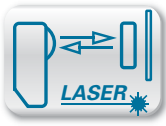

Tw = 22 ... 130 mm

- compact housing
- high repeatability
- sensing distance adjustable via potentiometer

general data

| | |
|-------------------------------------|-------------------------|
| type | background suppression |
| light source | pulsed red laser diode |
| sensing distance Tw | 22 ... 130 mm |
| sensing range Tb (at Tw max.) | 3 ... 130 mm |
| sensing range Tb (at Tw min.) | 3 ... 22 mm |
| repeat accuracy | < 0,2 mm at laser focus |
| power on indication | LED green |
| light indicator | LED yellow |
| sensing distance adjustment | mechanical, 5 turn |
| laser class | 2 |
| distance to focus | 40 mm |
| wave length | 650 nm |
| suppression of reciprocal influence | yes |

electrical data

| | |
|------------------------------------|----------------------|
| response time / release time | < 0,25 ms |
| voltage supply range +Vs | 11 ... 30 VDC |
| current consumption max. (no load) | 30 mA |
| current consumption typ. | 25 mA |
| voltage drop Vd | < 1,8 VDC |
| output function | light / dark operate |
| short circuit protection | yes |
| reverse polarity protection | yes, supply only |

mechanical data

| | |
|------------------|---------------|
| width / diameter | 10,4 mm |
| height / length | 27 mm |
| depth | 16,3 mm |
| type | rectangular |
| housing material | plastic (ASA) |
| front (optics) | PMMA |

ambient conditions

| | |
|-----------------------|----------------|
| operating temperature | -10 ... +50 °C |
|-----------------------|----------------|



connection diagrams



connectors

| | | |
|--------------|-------|--------------|
| ESG 32AH0200 | 4 pin | 2 m straight |
| ESW 31AH0200 | 4 pin | 2 m angular |

additional cable connectors and field wireable connectors, see accessories

accessories

| | |
|-----------------------------------|----------|
| SENSOFIX mounting kit | 10150326 |
| mounting bracket (cable type) | 10114501 |
| mounting bracket (connector type) | 10133792 |

for details, see accessories section

laser warning

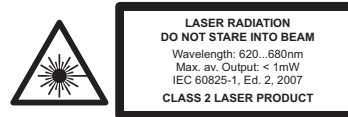

Complies with 21 CFR 1040.10 and 1040.11 except for deviations pursuant to laser notice No. 50, dated June 24, 2007

| order reference | connection types | output circuit | protection class | output current |
|-------------------|--------------------|----------------|------------------|----------------|
| OHDK 10N5101 | cable 4 pin, 2 m | NPN | IP 65 | < 70 mA |
| OHDK 10N5101/S35A | connector M8 4 pin | NPN | IP 67 | < 70 mA |
| OHDK 10P5101 | cable 4 pin, 2 m | PNP | IP 65 | < 100 mA |
| OHDK 10P5101/S35A | connector M8 4 pin | PNP | IP 67 | < 100 mA |

OHDK 10 Tw = 22 ... 130 mm Diffuse sensors with background suppression

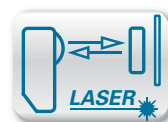

sensing distance diagram

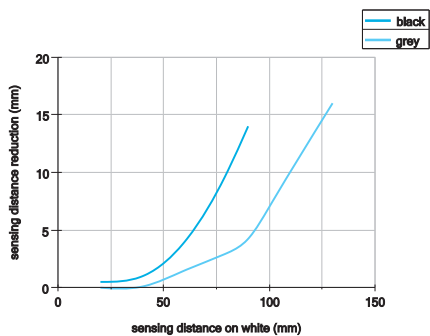

beam characteristic (typically)

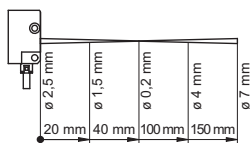

dimension drawings

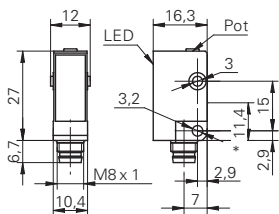

* emitter axis

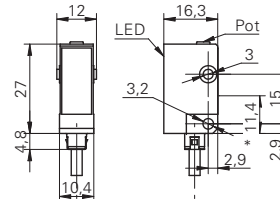

* emitter axis

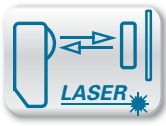

Tw = 22 ... 130 mm

- compact housing
- line beam
- sensing distance adjustable via potentiometer

general data

| | |
|-------------------------------------|-------------------------|
| type | background suppression |
| version | line beam |
| light source | pulsed red laser diode |
| sensing distance Tw | 22 ... 130 mm |
| sensing range Tb (at Tw max.) | 3 ... 130 mm |
| sensing range Tb (at Tw min.) | 3 ... 22 mm |
| repeat accuracy | < 0,2 mm at laser focus |
| power on indication | LED green |
| light indicator | LED yellow |
| sensing distance adjustment | mechanical, 5 turn |
| laser class | 1 |
| distance to focus | 40 mm |
| wave length | 650 nm |
| suppression of reciprocal influence | yes |

electrical data

| | |
|------------------------------------|----------------------|
| response time / release time | < 0,25 ms |
| voltage supply range +Vs | 11 ... 30 VDC |
| current consumption max. (no load) | 30 mA |
| current consumption typ. | 25 mA |
| voltage drop Vd | < 1,8 VDC |
| output function | light / dark operate |
| short circuit protection | yes |
| reverse polarity protection | yes, supply only |

mechanical data

| | |
|------------------|--------------------|
| width / diameter | 10,4 mm |
| height / length | 27 mm |
| depth | 16,3 mm |
| type | rectangular |
| housing material | plastic (ASA) |
| front (optics) | PMMA |
| connection types | connector M8 4 pin |

ambient conditions

| | |
|-----------------------|----------------|
| operating temperature | -10 ... +50 °C |
| protection class | IP 67 |

| order reference | output circuit | output current |
|-------------------|----------------|----------------|
| OHDK 10N5150/S35A | NPN | < 70 mA |
| OHDK 10P5150/S35A | PNP | < 100 mA |



connection diagrams



connectors

| | | |
|--------------|-------|--------------|
| ESG 32AH0200 | 4 pin | 2 m straight |
| ESW 31AH0200 | 4 pin | 2 m angular |

additional cable connectors and field wireable connectors, see accessories

accessories

| | |
|-----------------------------------|----------|
| SENSOFIX mounting kit | 10150326 |
| mounting bracket (cable type) | 10114501 |
| mounting bracket (connector type) | 10133792 |

for details, see accessories section

laser warning



Complies with 21 CFR 1040.10 and 1040.11 except for deviations pursuant to laser notice No. 50, dated June 24, 2007

OHDK 10 Tw = 22 ... 130 mm Diffuse sensors with background suppression

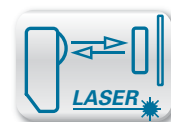

sensing distance diagram

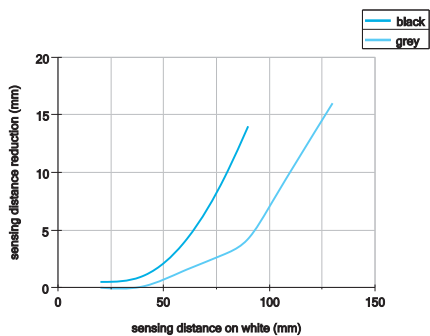

beam characteristic (typically)

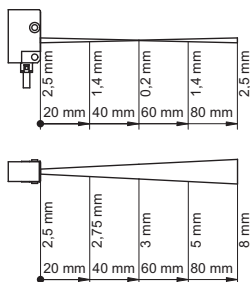

dimension drawing

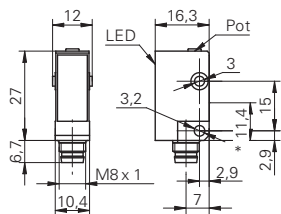

* emitter axis

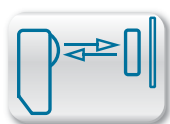

$T_w = 15 \dots 300 \text{ mm}$

- rugged miniature metal housing
- sensing distance adjustable via potentiometer
- suppression of mutual optical interference

general data

| | |
|-------------------------------------|------------------------|
| type | background suppression |
| light source | pulsed red LED |
| sensing distance T_w | 15 ... 300 mm |
| sensing range T_b (at T_w max.) | 15 ... 300 mm |
| sensing range T_b (at T_w min.) | 5 ... 15 mm |
| light indicator | LED yellow |
| sensing distance adjustment | mechanical, 5 turn |
| wave length | 660 nm |
| suppression of reciprocal influence | yes |

electrical data

| | |
|------------------------------------|----------------------|
| response time / release time | < 1 ms |
| voltage supply range +Vs | 10 ... 30 VDC |
| current consumption max. (no load) | 35 mA |
| current consumption typ. | 25 mA |
| voltage drop V_d | < 1,8 VDC |
| output function | light / dark operate |
| output current | < 100 mA |
| short circuit protection | yes |
| reverse polarity protection | yes |

mechanical data

| | |
|------------------|---------------|
| width / diameter | 12,4 mm |
| height / length | 35 mm |
| depth | 35 mm |
| type | rectangular |
| housing material | die-cast zinc |
| front (optics) | PMMA |

ambient conditions

| | |
|-----------------------|----------------|
| operating temperature | -25 ... +65 °C |
| protection class | IP 67 |

| order reference | connection types | output circuit |
|-------------------|--------------------|----------------|
| FHDM 12N5001 | cable 4 pin, 2 m | NPN |
| FHDM 12N5001/S35A | connector M8 4 pin | NPN |
| FHDM 12P5001 | cable 4 pin, 2 m | PNP |
| FHDM 12P5001/S35A | connector M8 4 pin | PNP |



connection diagrams



connectors

| | | |
|--------------|-------|--------------|
| ESG 32AH0200 | 4 pin | 2 m straight |
| ESW 31AH0200 | 4 pin | 2 m angular |

additional cable connectors and field wireable connectors, see accessories

accessories

| | |
|-----------------------|----------|
| SENSOFIX mounting kit | 10150328 |
| mounting bracket | 10113873 |

for details, see accessories section

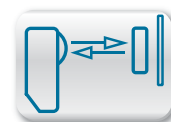

sensing distance diagram

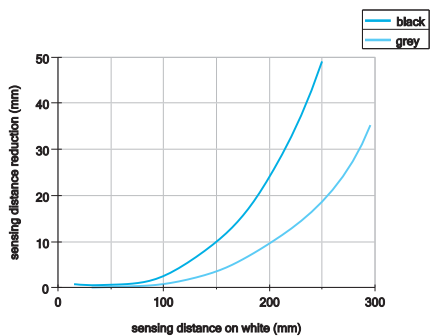

dimension drawings

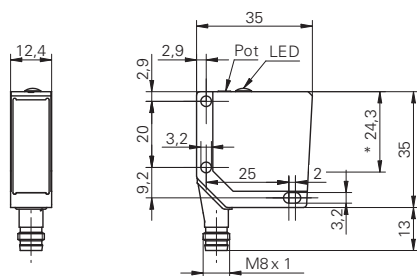

* emitter axis

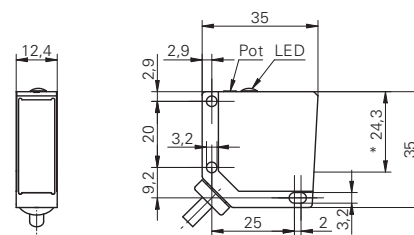

* emitter axis

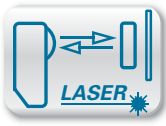

Tw = 17 ... 120 mm



- rugged miniature metal housing
- negligible black/white difference
- teachable sensing distance

general data

| | |
|-------------------------------|------------------------|
| type | background suppression |
| light source | pulsed red laser diode |
| sensing distance Tw | 17 ... 120 mm |
| sensing range Tb (at Tw max.) | 16 ... 120 mm |
| sensing range Tb (at Tw min.) | 16 ... 17 mm |
| power on indication | LED green |
| light indicator | LED red |
| sensing distance adjustment | Teach-in |
| laser class | 2 |
| wave length | 675 nm |
| beam diameter | 0,9 ... 0,5 mm |

electrical data

| | |
|------------------------------------|----------------------|
| response time | < 1 ms |
| release time | < 2,7 ms |
| voltage supply range +Vs | 12 ... 28 VDC |
| current consumption max. (no load) | 80 mA |
| current consumption typ. | 40 mA |
| voltage drop Vd | < 2,8 VDC |
| output function | light / dark operate |
| output current | < 100 mA |
| short circuit protection | yes |
| reverse polarity protection | yes, Vs to GND |

mechanical data

| | |
|------------------|--------------------|
| width / diameter | 12,4 mm |
| height / length | 37 mm |
| depth | 34,5 mm |
| type | rectangular |
| housing material | die-cast zinc |
| front (optics) | glass |
| connection types | connector M8 4 pin |

ambient conditions

| | |
|-----------------------|--------------|
| operating temperature | 0 ... +50 °C |
| protection class | IP 67 |

order reference output circuit

| | |
|--------------------------|-----|
| OHDM 12N6901/S35A | NPN |
| OHDM 12P6901/S35A | PNP |

connection diagrams

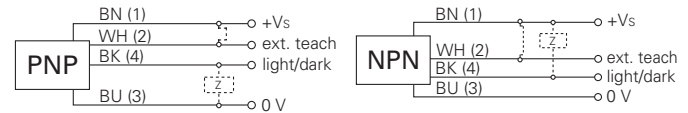

connectors

| | | |
|--------------|-------|--------------|
| ESG 32AH0200 | 4 pin | 2 m straight |
| ESW 31AH0200 | 4 pin | 2 m angular |

additional cable connectors and field wireable connectors, see accessories

accessories

| | |
|------------------------------|----------|
| <i>SENSOFIX</i> mounting kit | 10150328 |
| mounting bracket | 10113873 |

for details, see accessories section

laser warning



Complies with 21 CFR 1040.10 and 1040.11 except for deviations pursuant to laser notice No. 50, dated June 24, 2007

OHDM 12 Tw = 17 ... 120 mm Diffuse sensors with background suppression

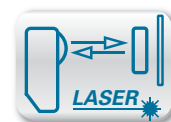

sensing distance diagram

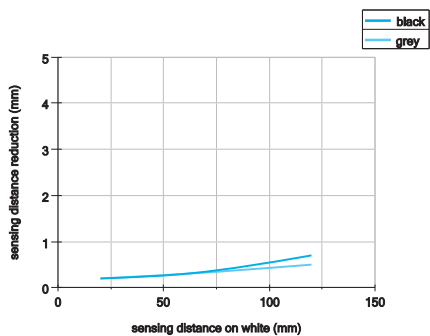

dimension drawing

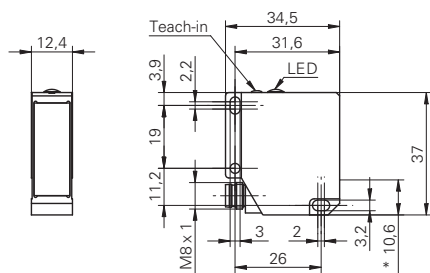

* emitter axis

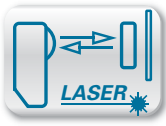

Tw = 50 ... 550 mm



- rugged metal housing
- negligible black/white difference
- teachable sensing distance

general data

| | |
|-------------------------------|------------------------|
| type | background suppression |
| light source | pulsed red laser diode |
| sensing distance Tw | 50 ... 550 mm |
| sensing range Tb (at Tw max.) | 50 ... 550 mm |
| sensing range Tb (at Tw min.) | 16 ... 17 mm |
| power on indication | LED green |
| light indicator | LED red |
| sensing distance adjustment | Teach-in |
| laser class | 2 |

electrical data

| | |
|------------------------------------|----------------------|
| response time | < 5 ms |
| release time | < 15 ms |
| voltage supply range +Vs | 12 ... 28 VDC |
| current consumption max. (no load) | 80 mA |
| current consumption typ. | 40 mA |
| voltage drop Vd | < 2,8 VDC |
| output function | light / dark operate |
| output current | < 100 mA |
| short circuit protection | yes |
| reverse polarity protection | yes, Vs to GND |

mechanical data

| | |
|------------------|--------------------|
| width / diameter | 13,4 mm |
| height / length | 48,2 mm |
| depth | 40 mm |
| type | rectangular |
| housing material | aluminum |
| front (optics) | glass |
| connection types | connector M8 4 pin |

ambient conditions

| | |
|-----------------------|--------------|
| operating temperature | 0 ... +50 °C |
| protection class | IP 67 |

connection diagrams



connectors

| | | |
|--------------|-------|--------------|
| ESG 32AH0200 | 4 pin | 2 m straight |
| ESW 31AH0200 | 4 pin | 2 m angular |

additional cable connectors and field wireable connectors, see accessories

accessories

| | |
|-----------------------|----------|
| SENSOFIX mounting kit | 10161829 |
| mounting bracket | 10161695 |

for details, see accessories section

laser warning

LASER RADIATION
DO NOT STARE INTO BEAM
 Wavelength: 620...680nm
 Max. av. Output: < 1mW
 IEC 60825-1, Ed. 2, 2007
CLASS 2 LASER PRODUCT

Complies with 21 CFR 1040.10 and 1040.11 except for deviations pursuant to laser notice No. 50, dated June 24, 2007

| order reference | output circuit | wave length | beam type | beam width | beam height | beam diameter |
|-------------------|----------------|-------------|-----------|------------|-------------|---------------|
| OHDM 13N6901/S35A | NPN | 675 nm | point | - | - | 1 mm |
| OHDM 13N6951/S35A | NPN | 650 nm | line | 2 mm | 4 ... 13 mm | - |
| OHDM 13P6901/S35A | PNP | 675 nm | point | - | - | 1 mm |
| OHDM 13P6951/S35A | PNP | 650 nm | line | 2 mm | 4 ... 13 mm | - |

OHDM 13 Tw = 50 ... 550 mm Diffuse sensors with background suppression

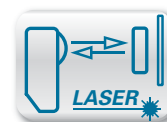

sensing distance diagram

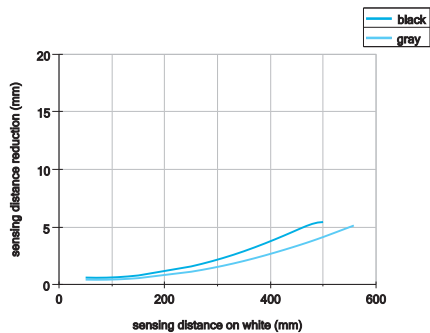

beam characteristic (typically)

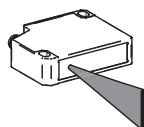

dimension drawing

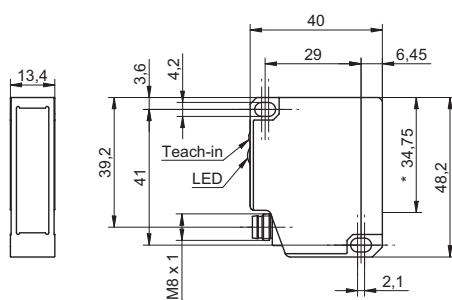

* emitter axis

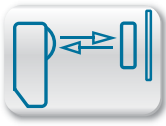

Tw = 20 ... 500 mm



- long range
- sensing distance adjustable via potentiometer
- suppression of mutual optical interference

general data

| | |
|-------------------------------------|--------------------------|
| type | background suppression |
| light source | pulsed red LED |
| alignment / soiled lens indicator | flashing light indicator |
| light indicator | LED yellow |
| sensing distance adjustment | mechanical, 10 turn |
| wave length | 660 nm |
| suppression of reciprocal influence | yes |

sensing distance Tw = 20 ... 350 mm

| | |
|-------------------------------|---------------|
| sensing range Tb (at Tw max.) | 20 ... 350 mm |
| sensing range Tb (at Tw min.) | 5 ... 20 mm |

sensing distance Tw = 30 ... 500 mm

| | |
|-------------------------------|---------------|
| sensing range Tb (at Tw max.) | 30 ... 500 mm |
| sensing range Tb (at Tw min.) | 5 ... 30 mm |

electrical data

| | |
|------------------------------------|----------------------|
| voltage supply range +Vs | 10 ... 30 VDC |
| current consumption max. (no load) | 30 mA |
| current consumption typ. | 25 mA |
| voltage drop Vd | < 1,8 VDC |
| output function | light / dark operate |
| output current | < 100 mA |
| short circuit protection | yes |
| reverse polarity protection | yes |

mechanical data

| | |
|------------------|---------------------|
| width / diameter | 14,8 mm |
| height / length | 43 mm |
| depth | 31 mm |
| type | rectangular |
| housing material | plastic (ASA, MABS) |
| front (optics) | PMMA |

ambient conditions

| | |
|-----------------------|----------------|
| operating temperature | -25 ... +65 °C |
| protection class | IP 67 |

connection diagrams



connectors

| | | |
|--------------|-------|--------------|
| ESG 32AH0200 | 4 pin | 2 m straight |
| ESW 31AH0200 | 4 pin | 2 m angular |

additional cable connectors and field wireable connectors, see accessories

accessories

| | |
|-----------------------|----------|
| SENSOFIX mounting kit | 10149011 |
| mounting bracket | 10134964 |

for details, see accessories section

| order reference | sensing distance Tw | connection types | output circuit | response time / release time |
|-------------------|---------------------|---------------------|----------------|------------------------------|
| FHDK 14N5101 | 20 ... 350 mm | cable 4 pin, 2 m | NPN | < 1 ms |
| FHDK 14N5101/S14 | 20 ... 350 mm | connector M12 4 pin | NPN | < 1 ms |
| FHDK 14N5101/S35A | 20 ... 350 mm | connector M8 4 pin | NPN | < 1 ms |
| FHDK 14N5104 | 30 ... 500 mm | cable 4 pin, 2 m | NPN | < 5 ms |
| FHDK 14N5104/S14 | 30 ... 500 mm | connector M12 4 pin | NPN | < 5 ms |
| FHDK 14N5104/S35A | 30 ... 500 mm | connector M8 4 pin | NPN | < 5 ms |
| FHDK 14P5101 | 20 ... 350 mm | cable 4 pin, 2 m | PNP | < 1 ms |
| FHDK 14P5101/S14 | 20 ... 350 mm | connector M12 4 pin | PNP | < 1 ms |
| FHDK 14P5101/S35A | 20 ... 350 mm | connector M8 4 pin | PNP | < 1 ms |
| FHDK 14P5104 | 30 ... 500 mm | cable 4 pin, 2 m | PNP | < 5 ms |
| FHDK 14P5104/S14 | 30 ... 500 mm | connector M12 4 pin | PNP | < 5 ms |
| FHDK 14P5104/S35A | 30 ... 500 mm | connector M8 4 pin | PNP | < 5 ms |

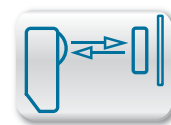

sensing distance diagrams

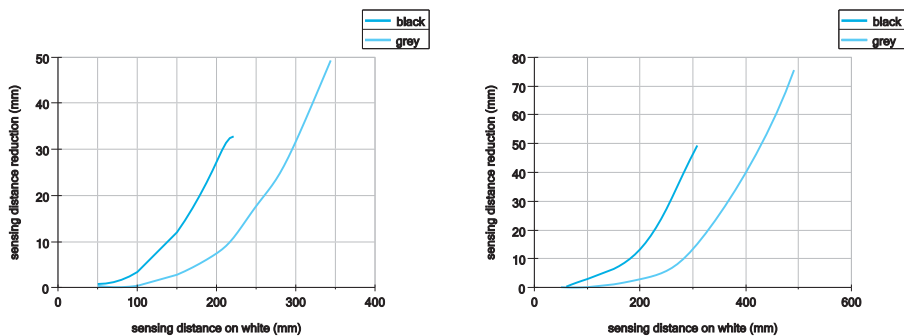

dimension drawings

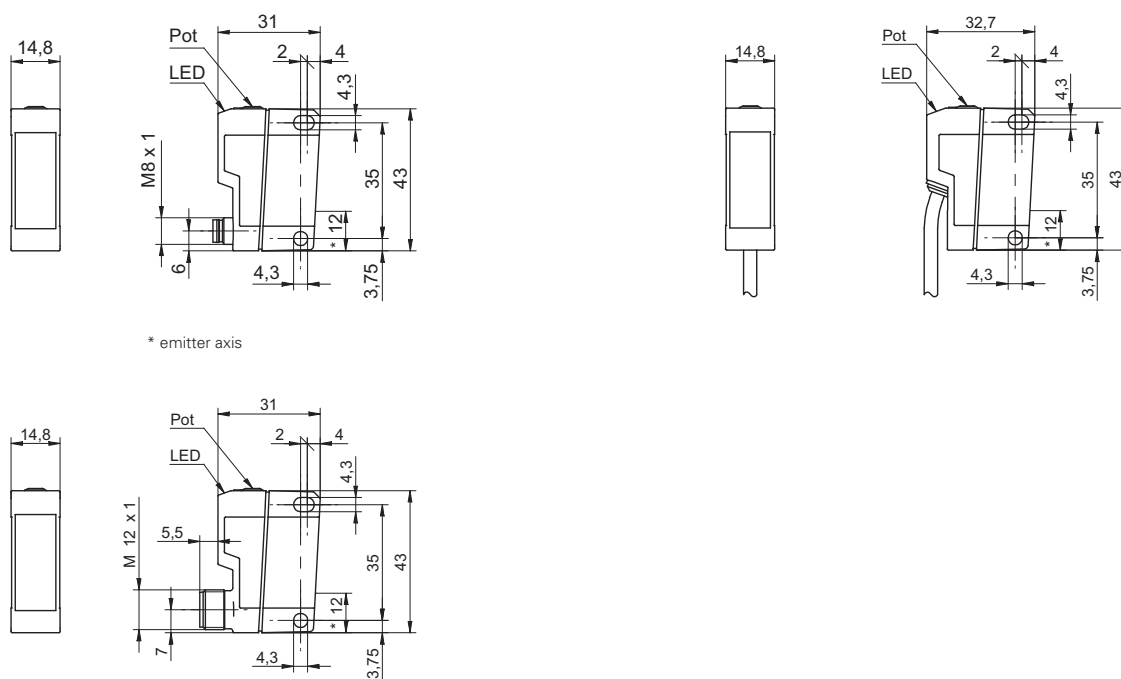

* emitter axis

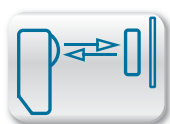

Tw = 40 ... 200 mm

- short response time
- sensing distance adjustable via Teach-in
- suppression of mutual optical interference

**general data**

| | |
|-------------------------------------|--------------------------|
| type | background suppression |
| light source | pulsed red LED |
| sensing distance Tw | 40 ... 200 mm |
| sensing range Tb (at Tw max.) | 20 ... 200 mm |
| sensing range Tb (at Tw min.) | 12 ... 40 mm |
| alignment / soiled lens indicator | flashing light indicator |
| light indicator | LED green |
| output indicator | LED yellow |
| sensing distance adjustment | Teach-in |
| wave length | 660 nm |
| suppression of reciprocal influence | yes |

electrical data

| | |
|------------------------------------|----------------------|
| response time / release time | < 0,5 ms |
| voltage supply range +Vs | 10 ... 30 VDC |
| current consumption max. (no load) | 40 mA |
| current consumption typ. | 35 mA |
| voltage drop Vd | < 1,8 VDC |
| output function | light / dark operate |
| output current | < 100 mA |
| short circuit protection | yes |
| reverse polarity protection | yes |

mechanical data

| | |
|------------------|---------------------|
| width / diameter | 14,8 mm |
| height / length | 43 mm |
| depth | 31 mm |
| type | rectangular |
| housing material | plastic (ASA, MABS) |
| front (optics) | PMMA |

ambient conditions

| | |
|-----------------------|----------------|
| operating temperature | -25 ... +65 °C |
| protection class | IP 67 |

| order reference | connection types | output circuit |
|-------------------|---------------------|----------------|
| FHDK 14N6901 | cable 4 pin, 2 m | NPN |
| FHDK 14N6901/S14 | connector M12 4 pin | NPN |
| FHDK 14N6901/S35A | connector M8 4 pin | NPN |
| FHDK 14P6901 | cable 4 pin, 2 m | PNP |
| FHDK 14P6901/S14 | connector M12 4 pin | PNP |
| FHDK 14P6901/S35A | connector M8 4 pin | PNP |

connection diagrams**connectors**

| | | |
|--------------|-------|--------------|
| ESG 32AH0200 | 4 pin | 2 m straight |
| ESW 31AH0200 | 4 pin | 2 m angular |

additional cable connectors and field wireable connectors, see accessories

accessories

| | |
|-----------------------|----------|
| SENSOFIX mounting kit | 10149011 |
| mounting bracket | 10134964 |

for details, see accessories section

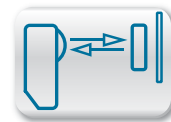

sensing distance diagram

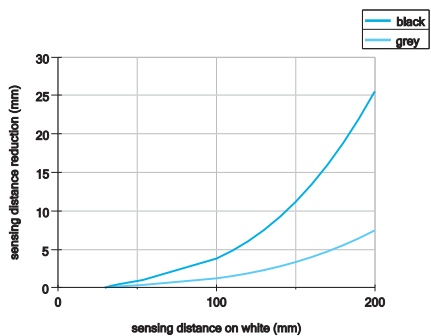

dimension drawing

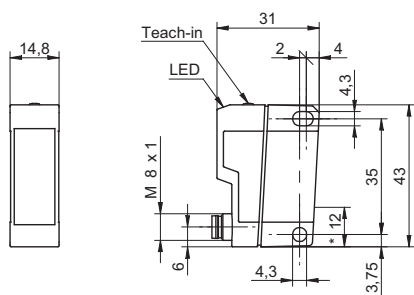

* emitter axis

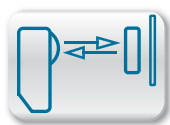

Tw = 50 ... 400 mm

- hygiene design
- IO-Link
- remote Teach-in



| general data | |
|-------------------------------|------------------------|
| type | background suppression |
| special type | Hygiene design |
| light source | pulsed red LED |
| sensing distance Tw | 50 ... 400 mm |
| sensing range Tb (at Tw max.) | 20 ... 400 mm |
| sensing range Tb (at Tw min.) | 20 ... 50 mm |
| power on indication | LED green |
| output indicator | LED red |
| wave length | 660 nm |
| approvals/certificates | Ecolab EHEDG |

| electrical data | |
|------------------------------------|----------------------|
| response time / release time | < 1,8 ms |
| voltage supply range +Vs | 10 ... 30 VDC |
| current consumption max. (no load) | 40 mA |
| current consumption typ. | 35 mA |
| voltage drop Vd | < 2 VDC |
| output function | light / dark operate |
| output circuit | push-pull |
| output current | < 100 mA |
| short circuit protection | yes |
| reverse polarity protection | yes |

| mechanical data | |
|------------------|-----------------------------------|
| width / diameter | 19,6 mm |
| height / length | 52,2 mm |
| depth | 34,3 mm |
| type | rectangular |
| housing material | stainless steel 1.4404 (V4A); LSR |
| front (optics) | PMMA |

| ambient conditions | |
|-----------------------|----------------------|
| operating temperature | -30 ... +60 °C |
| protection class | IP 68/69K & proTect+ |
| storage temperature | -30 ... +70 °C |

connection diagrams

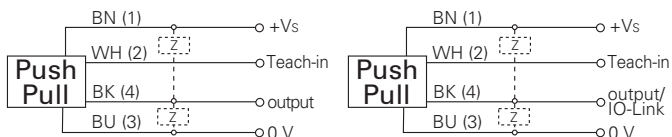

connectors

| | | |
|--------------|-------|--------------|
| ESG 34AF0200 | 4 pin | 2 m straight |
| ESW 33AF0200 | 4 pin | 2 m angular |

additional cable connectors and field wireable connectors, see accessories

accessories

| | | |
|----------|---------|---------|
| mounting | ø 17 mm | HI17-1H |
|----------|---------|---------|

for details, see accessories section

remarks

Sensor FDA compliant, EHEDG certified and Ecolab approved
 IO-Link: output signal, service status, object presence
 sensitivity adjustable: via Teach-in wire input
 LSR = Liquid Silicon Rubber

| order reference | connection types | sensing distance adjustment |
|-----------------------|---------------------------------|-----------------------------|
| FHDH 14G6901 | cable 4 pin, 2 m | Teach-in |
| FHDH 14G6901/IO | cable 4 pin, 2 m | Teach-in and IO-Link |
| FHDH 14G6901/KS34A | flylead connector M12, L=300 mm | Teach-in |
| FHDH 14G6901/KS34A/IO | flylead connector M12, L=300 mm | Teach-in and IO-Link |

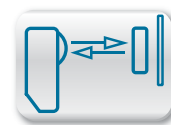

sensing distance diagram

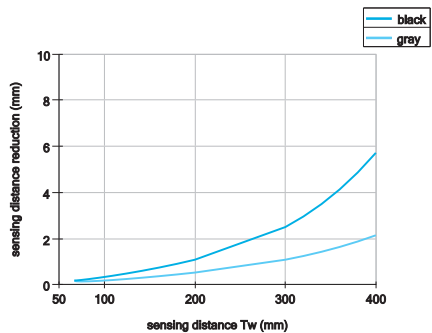

dimension drawings

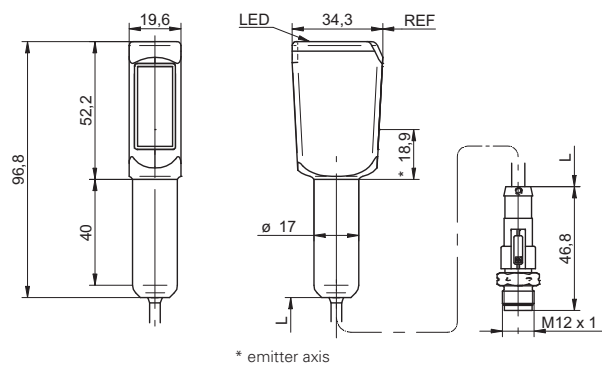
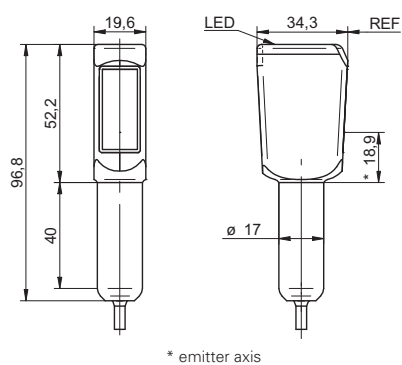

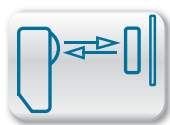

Tw = 50 ... 400 mm

- washdown design
- IO-Link
- Remote Teach-in

general data

| | |
|-------------------------------|------------------------|
| type | background suppression |
| special type | Washdown design |
| light source | pulsed red LED |
| sensing distance Tw | 50 ... 400 mm |
| sensing range Tb (at Tw max.) | 20 ... 400 mm |
| sensing range Tb (at Tw min.) | 20 ... 50 mm |
| power on indication | LED green |
| output indicator | LED red |
| wave length | 660 nm |
| approvals/certificates | Ecolab |

electrical data

| | |
|------------------------------------|----------------------|
| response time / release time | < 1,8 ms |
| voltage supply range +Vs | 10 ... 30 VDC |
| current consumption max. (no load) | 40 mA |
| current consumption typ. | 35 mA |
| voltage drop Vd | < 2 VDC |
| output function | light / dark operate |
| output circuit | push-pull |
| output current | < 100 mA |
| short circuit protection | yes |
| reverse polarity protection | yes |

mechanical data

| | |
|------------------|-----------------------------------|
| width / diameter | 19,6 mm |
| height / length | 51 mm |
| depth | 34,3 mm |
| type | rectangular |
| housing material | stainless steel 1.4404 (V4A); LSR |
| front (optics) | PMMA |
| connection types | connector M12 |

ambient conditions

| | |
|-----------------------|----------------------|
| operating temperature | -30 ... +60 °C |
| protection class | IP 68/69K & proTect+ |
| storage temperature | -30 ... +70 °C |

order reference

FHDR 14G6901/S14

sensing distance adjustment

Teach-in

FHDR 14G6901/S14/IO

Teach-in and IO-Link



connection diagrams

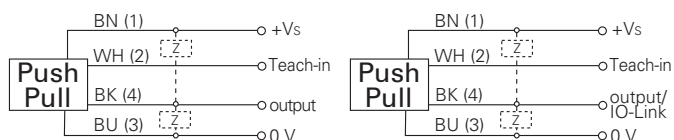

connectors

ESG 34AF0200 4 pin 2 m straight

ESW 33AF0200 4 pin 2 m angular

additional cable connectors and field wireable connectors, see accessories

accessories

SENSOFIX mounting kit 11046279

mounting bracket 11046278

for details, see accessories section

remarks

Sensor FDA compliant and Ecolab approved
 IO-Link: output signal, service status, object presence
 sensitivity adjustable: via Teach-in wire input
 LSR = Liquid Silicon Rubber

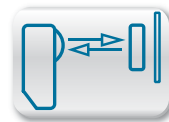

sensing distance diagram

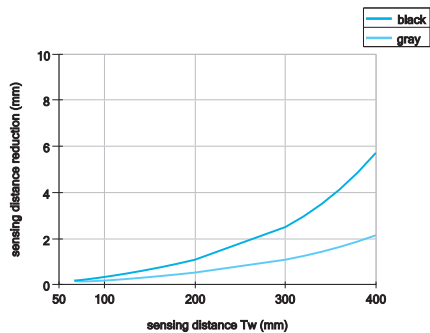

dimension drawing

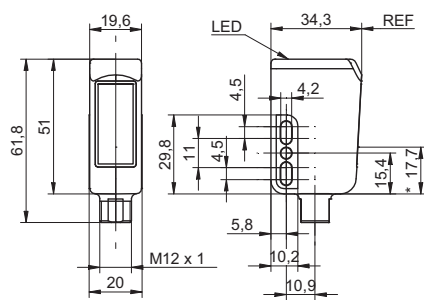

* emitter axis

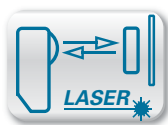

Tw = 20 ... 350 mm

- short response time
- high repeatability
- sensing distance adjustable via potentiometer

general data

| | |
|-------------------------------|-------------------------|
| type | background suppression |
| light source | pulsed red laser diode |
| sensing distance Tw | 20 ... 350 mm |
| sensing range Tb (at Tw max.) | 20 ... 350 mm |
| sensing range Tb (at Tw min.) | 5 ... 20 mm |
| repeat accuracy | < 0,2 mm at laser focus |
| power on indication | LED green |
| light indicator | LED yellow |
| sensing distance adjustment | mechanical, 9 turn |
| laser class | 2 |
| distance to focus | 115 mm |
| wave length | 650 nm |

electrical data

| | |
|------------------------------------|----------------------|
| response time / release time | < 0,5 ms |
| voltage supply range +Vs | 10 ... 30 VDC |
| current consumption max. (no load) | 35 mA |
| current consumption typ. | 25 mA |
| voltage drop Vd | < 2,2 VDC |
| output function | light / dark operate |
| output current | < 100 mA |
| short circuit protection | yes |
| reverse polarity protection | yes |

mechanical data

| | |
|------------------|---------------------|
| width / diameter | 14,8 mm |
| height / length | 43 mm |
| depth | 31 mm |
| type | rectangular |
| housing material | plastic (ASA, MABS) |
| front (optics) | PMMA |

ambient conditions

| | |
|-----------------------|----------------|
| operating temperature | -10 ... +50 °C |
| protection class | IP 67 |

| order reference | connection types | output circuit |
|-------------------|---------------------|----------------|
| OHDK 14N5101 | cable 4 pin, 2 m | NPN |
| OHDK 14N5101/S14 | connector M12 4 pin | NPN |
| OHDK 14N5101/S35A | connector M8 4 pin | NPN |
| OHDK 14P5101 | cable 4 pin, 2 m | PNP |
| OHDK 14P5101/S14 | connector M12 4 pin | PNP |
| OHDK 14P5101/S35A | connector M8 4 pin | PNP |

**connection diagrams****connectors**

| | | |
|--------------|-------|--------------|
| ESG 32AH0200 | 4 pin | 2 m straight |
| ESW 31AH0200 | 4 pin | 2 m angular |

additional cable connectors and field wireable connectors, see accessories

accessories

| | |
|-----------------------|----------|
| SENSOFIX mounting kit | 10149011 |
| mounting bracket | 10134964 |

for details, see accessories section

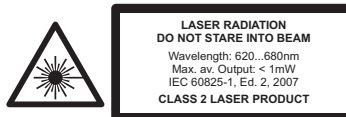
laser warning

Complies with 21 CFR 1040.10 and 1040.11 except for deviations pursuant to laser notice No. 50, dated June 24, 2007

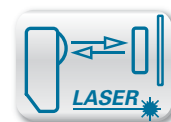

sensing distance diagram

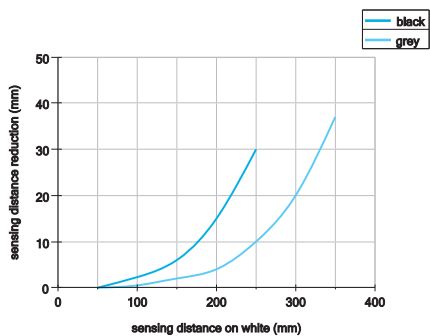

beam characteristic (typically)

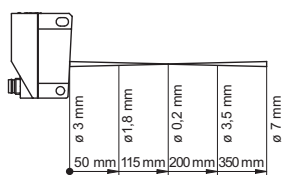

dimension drawing

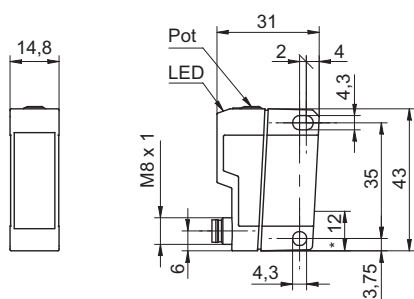

* emitter axis

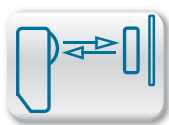

$T_w = 20 \dots 600 \text{ mm}$

- rugged metal housing
- sensing distance adjustable via potentiometer
- suppression of mutual optical interference



general data

| | |
|-------------------------------------|------------------------|
| type | background suppression |
| light source | pulsed red LED |
| sensing range T_b (at T_w min.) | 5 ... 20 mm |
| light indicator | LED yellow |
| sensing distance adjustment | mechanical, 5 turn |
| wave length | 660 nm |
| suppression of reciprocal influence | yes |

sensing distance $T_w = 20 \dots 450 \text{ mm}$

| | |
|-------------------------------------|---------------|
| sensing range T_b (at T_w max.) | 20 ... 450 mm |
|-------------------------------------|---------------|

sensing distance $T_w = 20 \dots 600 \text{ mm}$

| | |
|-------------------------------------|---------------|
| sensing range T_b (at T_w max.) | 20 ... 600 mm |
|-------------------------------------|---------------|

electrical data

| | |
|------------------------------------|----------------------|
| voltage supply range +Vs | 10 ... 30 VDC |
| current consumption max. (no load) | 41 mA |
| current consumption typ. | 29 mA |
| voltage drop V_d | < 1,8 VDC |
| output function | light / dark operate |
| output current | < 200 mA |
| short circuit protection | yes |
| reverse polarity protection | yes |

mechanical data

| | |
|------------------|---------------|
| width / diameter | 15,4 mm |
| height / length | 50 mm |
| depth | 50 mm |
| type | rectangular |
| housing material | die-cast zinc |
| front (optics) | PMMA |

ambient conditions

| | |
|-----------------------|----------------|
| operating temperature | -25 ... +65 °C |
| protection class | IP 67 |

connection diagrams



connectors

| | | |
|--------------|-------|--------------|
| ESG 34AH0200 | 4 pin | 2 m straight |
| ESW 33AH0200 | 4 pin | 2 m angular |

additional cable connectors and field wireable connectors, see accessories

accessories

| | |
|------------------------------|----------|
| <i>SENSOFIX</i> mounting kit | 10151721 |
| mounting bracket | 10113917 |

for details, see accessories section

| order reference | sensing distance T_w | connection types | output circuit | response time / release time |
|------------------|------------------------|---------------------|----------------|------------------------------|
| FHDM 16N5001 | 20 ... 450 mm | cable 4 pin, 2 m | NPN | < 1 ms |
| FHDM 16N5001/S14 | 20 ... 450 mm | connector M12 4 pin | NPN | < 1 ms |
| FHDM 16N5004 | 20 ... 600 mm | cable 4 pin, 2 m | NPN | < 5 ms |
| FHDM 16N5004/S14 | 20 ... 600 mm | connector M12 4 pin | NPN | < 5 ms |
| FHDM 16P5001 | 20 ... 450 mm | cable 4 pin, 2 m | PNP | < 1 ms |
| FHDM 16P5001/S14 | 20 ... 450 mm | connector M12 4 pin | PNP | < 1 ms |
| FHDM 16P5004 | 20 ... 600 mm | cable 4 pin, 2 m | PNP | < 5 ms |
| FHDM 16P5004/S14 | 20 ... 600 mm | connector M12 4 pin | PNP | < 5 ms |

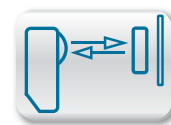

sensing distance diagrams

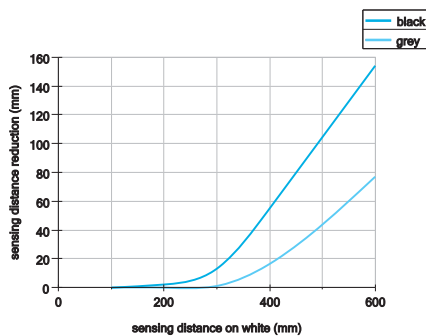
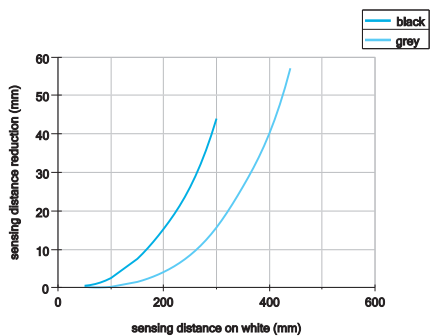

dimension drawings

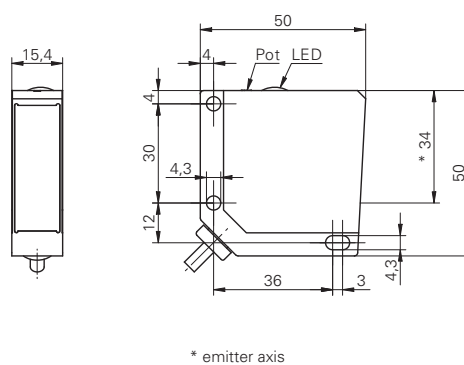
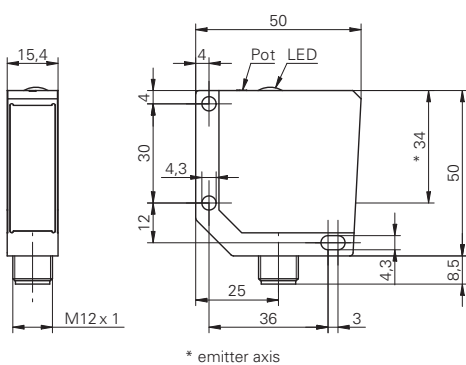

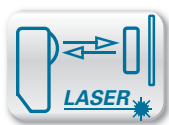

Tw = 25 ... 300 mm

- rugged metal housing
- long range
- high repeatability

general data

| | |
|-------------------------------|-------------------------|
| type | background suppression |
| light source | pulsed red laser diode |
| sensing distance Tw | 25 ... 300 mm |
| sensing range Tb (at Tw max.) | 40 ... 300 mm |
| sensing range Tb (at Tw min.) | 5 ... 25 mm |
| repeat accuracy | < 0,1 mm at laser focus |
| output indicator | LED yellow |
| sensing distance adjustment | mechanical, 8 turn |
| laser class | 2 |
| wave length | 650 nm |

electrical data

| | |
|------------------------------------|----------------------|
| voltage supply range +Vs | 10 ... 30 VDC |
| current consumption max. (no load) | 35 mA |
| current consumption typ. | 25 mA |
| voltage drop Vd | < 2 VDC |
| output function | light / dark operate |
| output current | < 200 mA |
| short circuit protection | yes |
| reverse polarity protection | yes |

mechanical data

| | |
|------------------|---------------|
| width / diameter | 15,4 mm |
| height / length | 50 mm |
| depth | 50 mm |
| type | rectangular |
| housing material | die-cast zinc |
| front (optics) | glass |

ambient conditions

| | |
|-----------------------|----------------|
| operating temperature | -10 ... +50 °C |
| protection class | IP 67 |



connection diagrams



connectors

| | | |
|--------------|-------|--------------|
| ESG 34AH0200 | 4 pin | 2 m straight |
| ESW 33AH0200 | 4 pin | 2 m angular |

additional cable connectors and field wireable connectors, see accessories

accessories

| | |
|----------------------------------|----------|
| SENSOFIX mounting kit | 10151721 |
| mounting bracket | 10113917 |
| lens cleaning air nozzle bracket | 10116407 |

for details, see accessories section

laser warning



Complies with 21 CFR 1040.10 and 1040.11 except for deviations pursuant to laser notice No. 50, dated June 24, 2007

| order reference | connection types | output circuit | response time / release time | distance to focus | suppression of reciprocal influence |
|------------------|---------------------|----------------|------------------------------|-------------------|-------------------------------------|
| OHDM 16N5001 | cable 4 pin, 2 m | NPN | < 0,6 ms | 80 mm | yes |
| OHDM 16N5001/S14 | connector M12 4 pin | NPN | < 0,6 ms | 80 mm | yes |
| OHDM 16P5001 | cable 4 pin, 2 m | PNP | < 0,6 ms | 80 mm | yes |
| OHDM 16P5001/S14 | connector M12 4 pin | PNP | < 0,6 ms | 80 mm | yes |
| OHDM 16P5002/S14 | connector M12 4 pin | PNP | < 0,6 ms | 40 mm | yes |
| OHDM 16P5012 | cable 4 pin, 2 m | PNP | < 0,1 ms | 60 mm | - |
| OHDM 16P5012/S14 | connector M12 4 pin | PNP | < 0,1 ms | 60 mm | - |

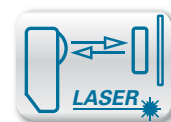

sensing distance diagram

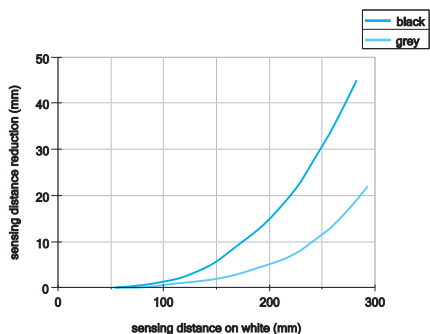

beam characteristics (typically)

distance to laser focus = 80 mm

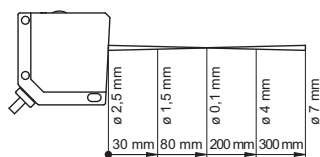

distance to laser focus = 40 mm

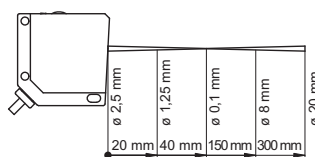

distance to laser focus = 60 mm

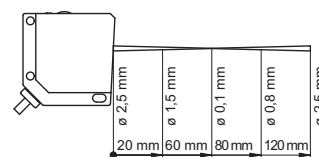

dimension drawings

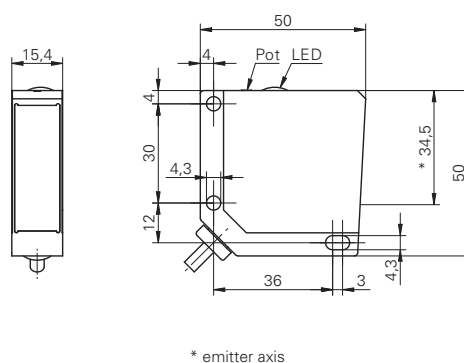
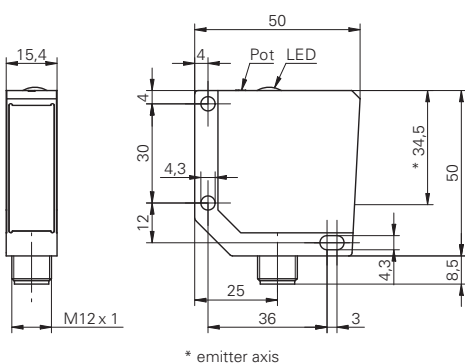

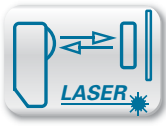

Tw = 133 mm

- for lateral detection of wafer edges
- very long range
- laser sensor in rugged metal housing



general data

| | |
|-------------------------------------|-------------------------|
| type | background suppression |
| version | wafer mapping sensor |
| light source | pulsed red laser diode |
| sensing distance Tw | 123 ... 143 mm |
| repeat accuracy | < 0,1 mm at laser focus |
| power on indication | LED green |
| output indicator | LED yellow |
| sensing distance adjustment | no |
| laser class | 2 |
| wave length | 650 nm |
| suppression of reciprocal influence | yes |

electrical data

| | |
|------------------------------------|----------------------|
| response time / release time | < 5 ms |
| voltage supply range +Vs | 10 ... 30 VDC |
| current consumption max. (no load) | 35 mA |
| current consumption typ. | 25 mA |
| voltage drop Vd | < 2 VDC |
| output function | light / dark operate |
| output current | < 200 mA |
| short circuit protection | yes |
| reverse polarity protection | yes |

mechanical data

| | |
|------------------|------------------|
| width / diameter | 15,4 mm |
| height / length | 50 mm |
| depth | 50 mm |
| type | rectangular |
| housing material | die-cast zinc |
| front (optics) | glass |
| connection types | cable 5 pin, 2 m |

ambient conditions

| | |
|-----------------------|---------------|
| operating temperature | -5 ... +50 °C |
| protection class | IP 67 |

order reference output circuit

| | |
|--------------|-----|
| OHDM 16N5651 | NPN |
| OHDM 16P5651 | PNP |

connection diagrams

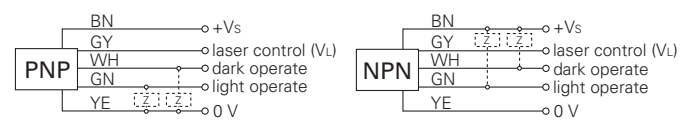

accessories

| | |
|----------------------------------|----------|
| SENSOFIX mounting kit | 10151721 |
| mounting bracket | 10113917 |
| lens cleaning air nozzle bracket | 10116407 |

for details, see accessories section

remarks

Function laser control - input:
 - Laser diode on VL < 1 V
 - Laser diode off VL > Vs - 4 V or open

laser warning



Complies with 21 CFR 1040.10 and 1040.11 except for deviations pursuant to laser notice No. 50, dated June 24, 2007

OHDM 16 Tw = 133 mm Diffuse sensors with background suppression

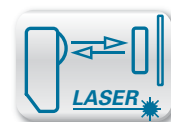

beam characteristics (typically)

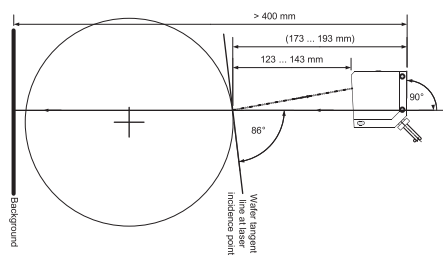
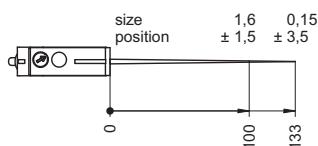
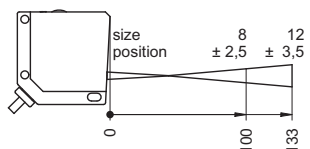

dimension drawing

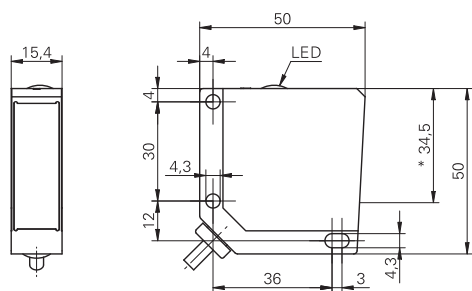

* emitter axis

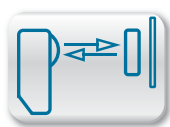

$T_w = 30 \dots 200 \text{ mm}$

- cross-technology housing concept
- sensing distance adjustable via Teach-in
- small mounting depth



general data

| | |
|-------------------------------------|--------------------------|
| type | background suppression |
| light source | pulsed red LED |
| sensing distance T_w | 30 ... 200 mm |
| sensing range T_b (at T_w max.) | 2 ... 200 mm |
| sensing range T_b (at T_w min.) | 12 ... 30 mm |
| alignment / soiled lens indicator | flashing light indicator |
| light indicator | LED green |
| output indicator | LED yellow |
| sensing distance adjustment | Teach-in |
| wave length | 660 nm |
| suppression of reciprocal influence | yes |

electrical data

| | |
|------------------------------------|----------------------|
| response time / release time | < 0,5 ms |
| voltage supply range +Vs | 12 ... 30 VDC |
| current consumption max. (no load) | 48 mA |
| current consumption typ. | 28 mA |
| voltage drop V_d | < 1,8 VDC |
| output function | light / dark operate |
| output current | < 100 mA |
| short circuit protection | yes |
| reverse polarity protection | yes |

mechanical data

| | |
|------------------|--------------------|
| width / diameter | 20 mm |
| height / length | 42 mm |
| depth | 15 mm |
| type | rectangular |
| housing material | plastic (PBT-ASA) |
| front (optics) | PMMA |
| connection types | connector M8 4 pin |

ambient conditions

| | |
|-----------------------|----------------|
| operating temperature | -25 ... +65 °C |
| protection class | IP 67 |

order reference

FHDK 20N6901/S35A
FHDK 20P6901/S35A

output circuit

NPN
PNP

connection diagrams

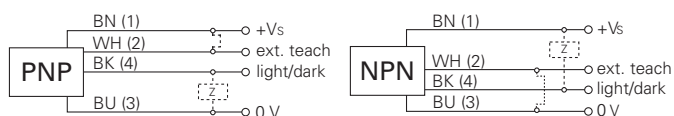

connectors

| | | |
|--------------|-------|--------------|
| ESG 32AH0200 | 4 pin | 2 m straight |
| ESW 31AH0200 | 4 pin | 2 m angular |

additional cable connectors and field wireable connectors, see accessories

accessories

| | |
|-----------------------|----------|
| SENSOFIX mounting kit | 10150326 |
|-----------------------|----------|

for details, see accessories section

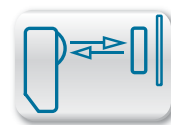

sensing distance diagram

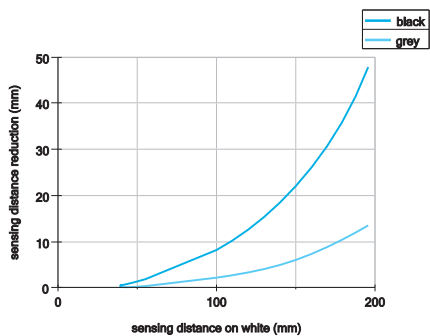

dimension drawing

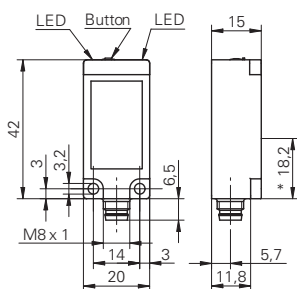

* emitter axis

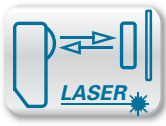

Tw = 210 ... 1500 mm

- long range
- negligible black/white difference
- two teachable sensing distances



general data

| | |
|-------------------------------|------------------------|
| type | background suppression |
| light source | pulsed red laser diode |
| sensing distance Tw | 210 ... 1500 mm |
| sensing range Tb (at Tw max.) | 200 ... 1500 mm |
| sensing range Tb (at Tw min.) | 200 ... 210 mm |
| power on indication | LED green |
| light indicator | LED red |
| sensing distance adjustment | Teach-in |
| laser class | 2 |
| wave length | 650 nm |
| beam diameter | 2 mm |

electrical data

| | |
|------------------------------------|----------------------|
| response time | < 6 ms |
| release time | < 18 ms |
| voltage supply range +Vs | 12 ... 28 VDC |
| current consumption max. (no load) | 100 mA |
| voltage drop Vd | < 5 VDC |
| output function | light / dark operate |
| output circuit | PNP |
| output current | < 20 mA |
| short circuit protection | yes |
| reverse polarity protection | yes, Vs to GND |

mechanical data

| | |
|------------------|---------------------|
| width / diameter | 20,6 mm |
| height / length | 65 mm |
| depth | 50 mm |
| type | rectangular |
| housing material | die-cast zinc |
| front (optics) | glass |
| connection types | connector M12 5 pin |

ambient conditions

| | |
|-----------------------|--------------|
| operating temperature | 0 ... +50 °C |
| protection class | IP 67 |

order reference

OHDM 20P6990/S14C

connection diagram

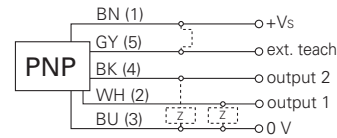

connectors

| | | |
|----------|-------|--------------|
| ES 34CP2 | 5 pin | 2 m straight |
| ES 33CP2 | 5 pin | 2 m angular |

additional cable connectors and field wireable connectors, see accessories

accessories

| | |
|------------------|----------|
| mounting bracket | 10131521 |
| protector cap | 10156878 |

for details, see accessories section

laser warning



Complies with 21 CFR 1040.10 and 1040.11 except for deviations pursuant to laser notice No. 50, dated June 24, 2007

OHDM 20 Tw = 210 ... 1500 mm Diffuse sensors with background suppression

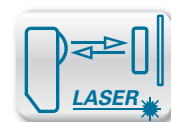

sensing distance diagram

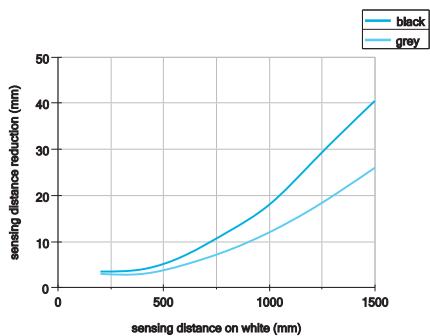

dimension drawing

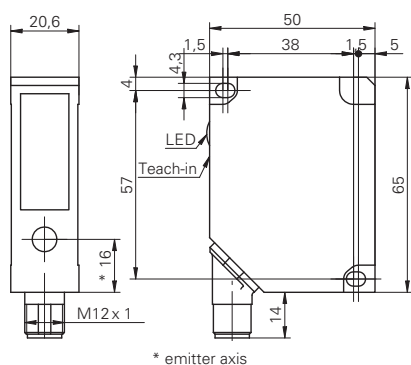

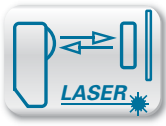

Tw = 100 ... 1000 mm



- qTeach
- no black/white difference

general data

| | |
|---|------------------------|
| type | background suppression |
| light source | pulsed red laser diode |
| sensing distance Tw | 100 ... 1000 mm |
| adjusting range (object reflectivity $\geq 18\%$, grey) | 100 ... 935 mm |
| adjusting range (object reflectivity $\leq 18\%$... 6%, black) | 100 ... 450 mm |
| power on indication | LED green |
| light indicator | LED yellow |
| sensing distance adjustment | Teach-in |
| laser class | 1 |
| wave length | 656 nm |
| beam diameter | 3,7 ... 13 mm |
| black/white shift | 0% |

electrical data

| | |
|------------------------------------|----------------------|
| response time / release time | < 6 ms |
| voltage supply range +Vs | 10 ... 30 VDC |
| current consumption max. (no load) | 80 mA |
| voltage drop Vd | < 3,5 VDC |
| output function | light / dark operate |
| output circuit | push-pull |
| output current | < 100 mA |
| short circuit protection | yes |
| reverse polarity protection | yes |

mechanical data

| | |
|------------------|--------------------------|
| width / diameter | 23,4 mm |
| height / length | 63 mm |
| depth | 45 mm |
| type | rectangular |
| housing material | plastic (SAN LURAN 378P) |
| front (optics) | PMMA |
| connection types | connector M12 4 pin |

ambient conditions

| | |
|-----------------------|----------------|
| operating temperature | 0 ... +50 °C |
| protection class | IP 67 |
| storage temperature | -10 ... +70 °C |

order reference

OHDK 25G6921/S14

connection diagram

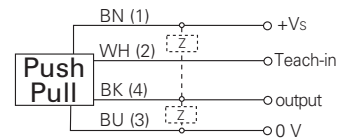

connectors

| | | |
|--------------|-------|--------------|
| ESG 34AH0200 | 4 pin | 2 m straight |
| ESW 33AH0200 | 4 pin | 2 m angular |

additional cable connectors and field wireable connectors, see accessories

laser warning



Complies with 21 CFR 1040.10 and 1040.11 except for deviations pursuant to laser notice No. 50, dated June 24, 2007

OHDK 25 Tw = 100 ... 1000 mm

Diffuse sensors with background suppression

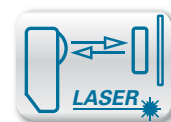

sensing distance diagram

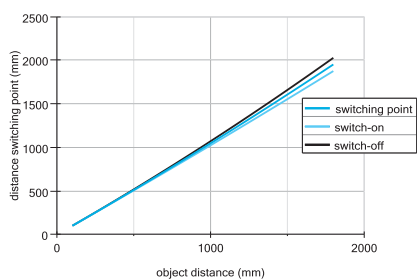

dimension drawings

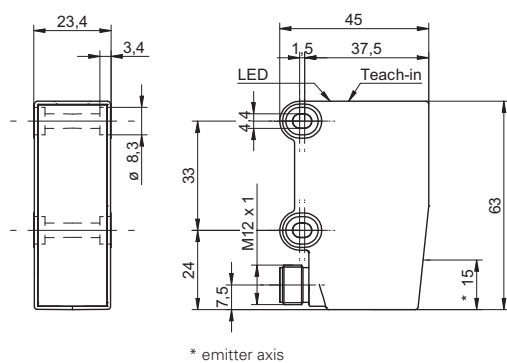

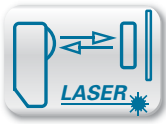

Tw = 100 ...2000 mm



- qTeach
- no black/white difference
- 1 or 2 switching outputs

general data

| | |
|---|------------------------|
| type | background suppression |
| light source | pulsed red laser diode |
| sensing distance Tw | 100 ... 2000 mm |
| adjusting range (object reflectivity ≥18%, grey) | 100 ... 1750 mm |
| adjusting range (object reflectivity ≤18 ... 6%, black) | 100 ... 860 mm |
| power on indication | LED green |
| light indicator | LED yellow |
| sensing distance adjustment | Teach-in |
| laser class | 1 |
| wave length | 656 nm |
| beam diameter | 3,7 ... 22 mm |
| black/white shift | 0% |

electrical data

| | |
|------------------------------------|----------------------|
| response time / release time | < 10 ms |
| voltage supply range +Vs | 10 ... 30 VDC |
| current consumption max. (no load) | 80 mA |
| voltage drop Vd | < 3,5 VDC |
| output function | light / dark operate |
| output circuit | push-pull |
| output current | < 100 mA |
| short circuit protection | yes |
| reverse polarity protection | yes |

mechanical data

| | |
|------------------|--------------------------|
| width / diameter | 23,4 mm |
| height / length | 63 mm |
| depth | 45 mm |
| type | rectangular |
| housing material | plastic (SAN LURAN 378P) |
| front (optics) | PMMA |
| connection types | connector M12 4 pin |

ambient conditions

| | |
|-----------------------|----------------|
| operating temperature | 0 ... +50 °C |
| protection class | IP 67 |
| storage temperature | -10 ... +70 °C |

order reference

| order reference | number of outputs |
|-------------------|-------------------|
| OHDK 25G6911/S14 | 1 |
| OHDK 25G6912/S14C | 2 |

connection diagrams

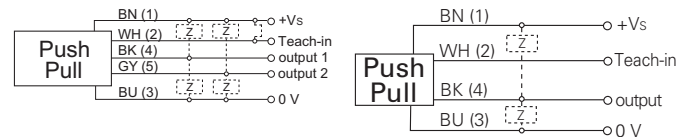

connectors

| | | |
|--------------|-------|--------------|
| ESG 34AH0200 | 4 pin | 2 m straight |
| ESW 33AH0200 | 4 pin | 2 m angular |

additional cable connectors and field wireable connectors, see accessories

laser warning



Complies with 21 CFR 1040.10 and 1040.11 except for deviations pursuant to laser notice No. 50, dated June 24, 2007

OHDK 25 Tw = 100 ...2000 mm

Diffuse sensors with background suppression

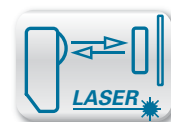



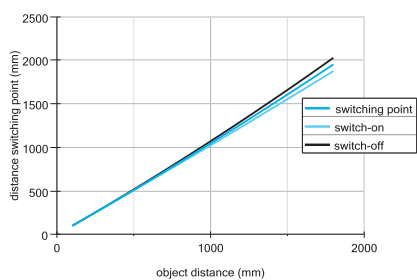

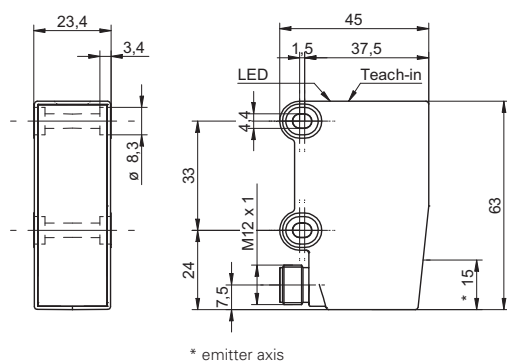

sensing distance diagram







dimension drawings



red light LED version

| product family | FZCK 07 | FZDK 07 | FZDM 08 | FZAM 08 | FZDK 10 | FZAM 12 | FZDK 14 |
|------------------------------|---|---|---|---|---|---|---|
| |  |  |  |  |  |  |  |
| | <i>MINOS</i> | <i>MINOS</i> | | | | | |
| width / diameter | 8 mm | 8 mm | 8 mm | 8 mm | 10,4 mm | 12 mm | 14,8 mm |
| sensing distance Tw | 20 ... 150 mm | 20 ... 150 mm | < 40 mm < 80 mm | < 40 mm < 80 mm | 5 ... 200 mm | 30 ... 200 mm | 5 ... 600 mm |
| response time / release time | < 0,5 ms | < 0,5 ms | < 1 ms | < 1 ms | < 1 ms | < 1 ms | < 1 ms |
| sensitivity adjustment | Teach-in | Teach-in | no | no | potentiometer, 270° | potentiometer, 270° | potentiometer, 270° |
| NPN | ■ | ■ | | | ■ | ■ | ■ |
| PNP | ■ | ■ | ■ | ■ | ■ | ■ | ■ |
| cable | ■ | ■ | ■ | ■ | ■ | ■ | ■ |
| flylead connector | ■ | ■ | | | ■ | | |
| connector | | | ■ | ■ | ■ | ■ | ■ |
| housing material | plastic | plastic | metal | metal | plastic | metal | plastic |
| page | 148 | 150 | 152 | 154 | 156 | 162 | 164 |

laser version

| product family | OZDK 10 | OZDK 10 | OZDK 14 | OZDM 16 | OZDM 16 |
|------------------------------|---|---|---|---|---|
| |  |  |  |  |  |
| version | | line beam | | | |
| width / diameter | 10,4 mm | 10,4 mm | 14,8 mm | 15,4 mm | 15,4 mm |
| sensing distance Tw | 3 ... 150 mm | 3 ... 150 mm | 20 ... 300 mm | 0 ... 250 mm | 0 ... 250 mm |
| response time / release time | < 0,05 ms | < 0,05 ms | < 0,15 ms | < 0,05 ms | < 0,1 ms |
| sensitivity adjustment | potentiometer, 5 turn | potentiometer, 5 turn | Teach-in | potentiometer, 14 turn | potentiometer, 14 turn |
| NPN | ■ | ■ | ■ | ■ | |
| PNP | ■ | ■ | ■ | ■ | ■ |
| cable | ■ | ■ | ■ | ■ | ■ |
| connector | ■ | ■ | ■ | ■ | ■ |
| housing material | plastic | plastic | plastic | metal | metal |
| page | 158 | 160 | 166 | 170 | 172 |

| FZDM 16 | FZAM 18 | FZAM 18 | FZAM 18 | FZDK 20 | FZAM 30 |
|---------|---------|---------|---------|---------|---------|
|---------|---------|---------|---------|---------|---------|



| | | | | | |
|------------------------|---------------|---------------------------|------------------------|------------------------|-----------------------------------|
| 15,4 mm | 18 mm | 18 mm | 18 mm | 20 mm | 30 mm |
| 0 ... 400 mm | 60 ... 430 mm | 20 ... 150 mm | 60 ... 430 mm | 5 ... 500 mm | 100 ... 700 mm 300 ... 1500 mm |
| < 1 ms | < 1 ms | < 0,5 ms | < 1 ms | < 0,5 ms | < 0,25 ms < 2,5 ms |
| potentiometer, 270° | Teach-in | potentiometer, 15 turn | potentiometer, 270° | potentiometer, 270° | potentiometer, 15 turn |
| ■ | ■ | ■ | ■ | ■ | ■ |
| ■ | ■ | ■ | ■ | ■ | ■ |
| ■ | ■ | ■ | ■ | | ■ |
| ■ | ■ | | ■ | ■ | |
| metal | metal | metal | metal | plastic | metal |
| 168 | 174 | 176 | 178 | 180 | 182 |



General information

The emitter and receiver are in the same housing. The emitted infrared, red or laser light is reflected directly by the target back to the sensor. If the target reflects sufficiently well, the received light causes the sensor to switch.

Applications

- Differentiation and sorting of objects, e.g. by size, degree of reflection etc.
- Counting of objects
- Presence check, e.g. of a paper stack.

Characteristics and advantages

- Exploitation of the reflection from the target
 - Suitable to discern black from white
 - Relatively large active range
 - Simple installation (only one sensor)
 - Short response time
- The sensing distance depends largely on the reflective properties of the object surface.
 - Positioning and monitoring with just one sensor.

Technology and operation

The light shining on the target is largely diffused and reflected back in all directions. A very small part of this remitted light is observed by the receiver. If the target reflects sufficiently well, the received light causes the sensor to switch.

As the sensor operates with the reflection from the materials, the surface properties, color and gloss have a great influence on the switching distance.

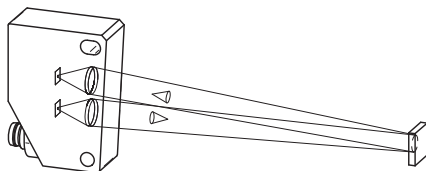



Mounting and adjustment

With diffuse sensors operating by the intensity difference principle, the relative receiving signal is specified. This represents the signal level received from a white object as a function of the distance. Using this diagram, the sensing range can be determined for an object which is not white. The correction factor of the respective material is required for this purpose.

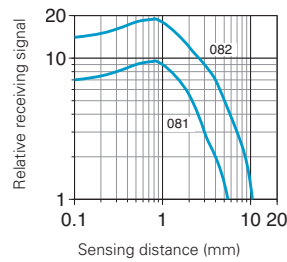

Correction factor

The material and surface properties of the object (representing the reflectivity) influence the switching distance of a diffuse sensor with intensity difference. To determine the corrected switching distance, the following values must therefore be applied to the relative receiving signal (KFs) or in approximation to the distance (KFd).

| Material | KFs | KFd |
|------------------------|-------|-------|
| Kodak test card | 100 % | 100 % |
| Pale, planed wood | 80 % | 90 % |
| Rough wood | 20 % | 45 % |
| Drawn aluminum | 25 % | 50 % |
| Cardboard, matte black | 7 % | 26 % |

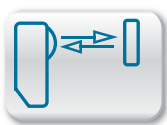

$T_w = 20 \dots 150 \text{ mm}$

- ultra compact housing
- sensitivity adjustable via Teach-in
- suppression of mutual optical interference

general data

| | |
|-------------------------------------|--------------------------|
| type | intensity difference |
| light source | pulsed red LED |
| sensing distance T_w | 20 ... 150 mm |
| alignment / soiled lens indicator | flashing light indicator |
| light indicator | LED green |
| output indicator | LED yellow |
| sensitivity adjustment | Teach-in |
| wave length | 660 nm |
| suppression of reciprocal influence | yes |

electrical data

| | |
|------------------------------------|----------------------|
| response time / release time | < 0,5 ms |
| voltage supply range +Vs | 10 ... 30 VDC |
| current consumption max. (no load) | 25 mA |
| current consumption typ. | 20 mA |
| voltage drop V_d | < 1,8 VDC |
| output function | light / dark operate |
| output current | < 100 mA |
| short circuit protection | yes |
| reverse polarity protection | yes |

mechanical data

| | |
|------------------|--------------------------|
| width / diameter | 8 mm |
| height / length | 16,2 mm |
| depth | 10,8 mm |
| type | rectangular |
| housing material | plastic (PMMA, MABS, PA) |
| front (optics) | PMMA |

ambient conditions

| | |
|-----------------------|----------------|
| operating temperature | -20 ... +50 °C |
| protection class | IP 65 |

| order reference | connection types | output circuit |
|--------------------|----------------------------|----------------|
| FZCK 07N6901 | cable rear side, 2 m | NPN |
| FZCK 07N6901/KS35A | flylead connector M8 4 pin | NPN |
| FZCK 07P6901 | cable rear side, 2 m | PNP |
| FZCK 07P6901/KS35A | flylead connector M8 4 pin | PNP |



connection diagrams



connectors

| | | |
|--------------|-------|--------------|
| ESG 32AH0200 | 4 pin | 2 m straight |
| ESW 31AH0200 | 4 pin | 2 m angular |

additional cable connectors and field wireable connectors, see accessories

accessories

| | |
|----------------------|----------|
| MINOFIX mounting kit | 10150844 |
|----------------------|----------|

for details, see accessories section

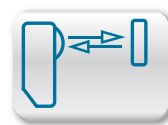

relative receiving signal

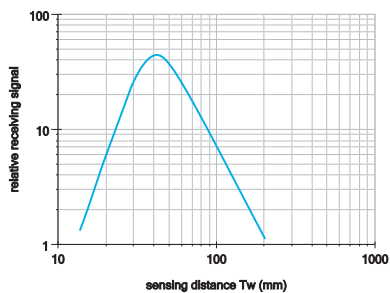

dimension drawings

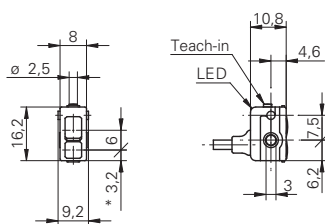

* emitter axis

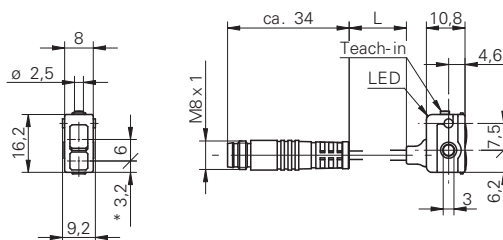

* emitter axis cable length L = 200 mm

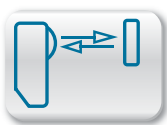

$T_w = 20 \dots 150 \text{ mm}$

- ultra compact housing
- sensitivity adjustable via Teach-in
- suppression of mutual optical interference

general data

| | |
|-------------------------------------|--------------------------|
| type | intensity difference |
| light source | pulsed red LED |
| sensing distance T_w | 20 ... 150 mm |
| alignment / soiled lens indicator | flashing light indicator |
| light indicator | LED green |
| output indicator | LED yellow |
| sensitivity adjustment | Teach-in |
| wave length | 660 nm |
| suppression of reciprocal influence | yes |

electrical data

| | |
|------------------------------------|----------------------|
| response time / release time | < 0,5 ms |
| voltage supply range +Vs | 10 ... 30 VDC |
| current consumption max. (no load) | 25 mA |
| current consumption typ. | 20 mA |
| voltage drop V_d | < 1,8 VDC |
| output function | light / dark operate |
| output current | < 100 mA |
| short circuit protection | yes |
| reverse polarity protection | yes |

mechanical data

| | |
|------------------|--------------------------|
| width / diameter | 8 mm |
| height / length | 16,2 mm |
| depth | 10,8 mm |
| type | rectangular |
| housing material | plastic (PMMA, MABS, PA) |
| front (optics) | PMMA |

ambient conditions

| | |
|-----------------------|----------------|
| operating temperature | -20 ... +50 °C |
| protection class | IP 65 |

| order reference | connection types | output circuit |
|--------------------|----------------------------|----------------|
| FZDK 07N6901 | cable bottom side, 2 m | NPN |
| FZDK 07N6901/KS35A | flylead connector M8 4 pin | NPN |
| FZDK 07P6901 | cable bottom side, 2 m | PNP |
| FZDK 07P6901/KS35A | flylead connector M8 4 pin | PNP |



connection diagrams



connectors

| | | |
|--------------|-------|--------------|
| ESG 32AH0200 | 4 pin | 2 m straight |
| ESW 31AH0200 | 4 pin | 2 m angular |

additional cable connectors and field wireable connectors, see accessories

accessories

| | |
|----------------------|----------|
| MINOFIX mounting kit | 10150844 |
|----------------------|----------|

for details, see accessories section

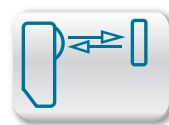

relative receiving signal

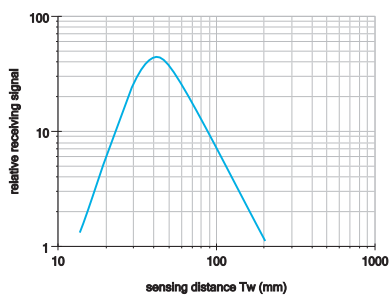

dimension drawings

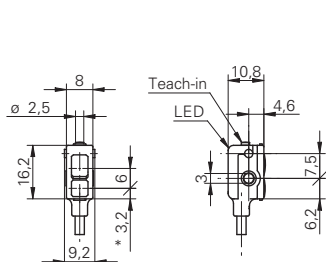

\ast emitter axis

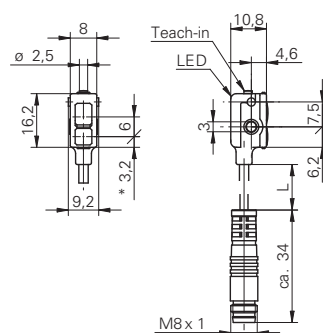

\ast emitter axis cable length L = 200 mm

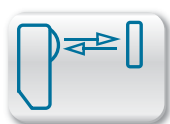

$T_w = 80 \text{ mm}$

- subminiature metal housing
- fixed sensing distance

general data

| | |
|-------------------------------------|--------------------------|
| type | intensity difference |
| light source | pulsed infrared diode |
| alignment / soiled lens indicator | flashing light indicator |
| light indicator | LED red |
| sensitivity adjustment | no |
| wave length | 880 nm |
| suppression of reciprocal influence | yes |

electrical data

| | |
|------------------------------------|---------------|
| response time / release time | < 1 ms |
| voltage supply range +Vs | 10 ... 30 VDC |
| current consumption max. (no load) | 42 mA |
| current consumption typ. | 20 mA |
| voltage drop Vd | < 2 VDC |
| output circuit | PNP |
| output current | < 100 mA |
| short circuit protection | yes |
| reverse polarity protection | yes |

mechanical data

| | |
|------------------|-------------------|
| width / diameter | 8 mm |
| height / length | 58 mm |
| depth | 12 mm |
| type | rectangular |
| housing material | aluminum anodized |
| front (optics) | PC |

ambient conditions

| | |
|-----------------------|----------------|
| operating temperature | -25 ... +65 °C |
| protection class | IP 65 |



connection diagram

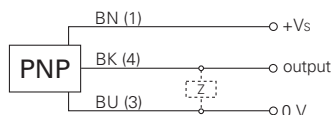

connectors

| | | |
|--------------|-------|--------------|
| ESG 32SH0200 | 3 pin | 2 m straight |
| ESW 31SH0200 | 3 pin | 2 m angular |

additional cable connectors and field wireable connectors, see accessories

| order reference | sensing distance T_w | connection types | output function |
|-------------------|------------------------|---------------------|-----------------|
| FZDM 08P1001 | < 40 mm | cable 3 pin, 2 m | light operate |
| FZDM 08P1001/S35L | < 40 mm | connector M8, 3 pin | light operate |
| FZDM 08P1002 | < 80 mm | cable 3 pin, 2 m | light operate |
| FZDM 08P1002/S35L | < 80 mm | connector M8, 3 pin | light operate |
| FZDM 08P3001 | < 40 mm | cable 3 pin, 2 m | dark operate |
| FZDM 08P3001/S35L | < 40 mm | connector M8, 3 pin | dark operate |
| FZDM 08P3002 | < 80 mm | cable 3 pin, 2 m | dark operate |
| FZDM 08P3002/S35L | < 80 mm | connector M8, 3 pin | dark operate |

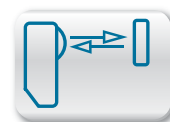

relative receiving signals

Tw < 40 mm

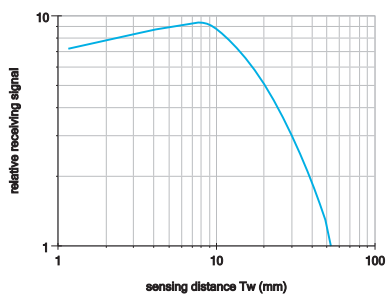

Tw < 80 mm

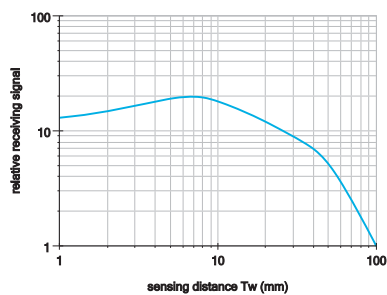

dimension drawings

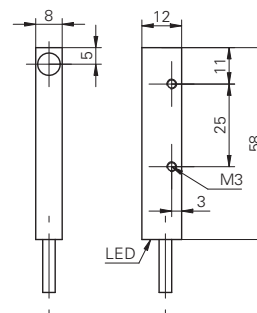
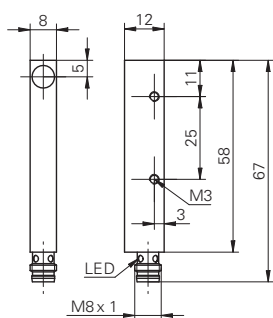

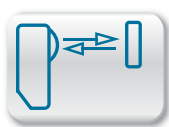

Tw = 80 mm

- subminiature metal housing
- fixed sensing distance

general data

| | |
|-------------------------------------|--------------------------|
| type | intensity difference |
| light source | pulsed infrared diode |
| alignment / soiled lens indicator | flashing light indicator |
| light indicator | LED red |
| sensitivity adjustment | no |
| wave length | 880 nm |
| suppression of reciprocal influence | yes |

electrical data

| | |
|------------------------------------|---------------|
| response time / release time | < 1 ms |
| voltage supply range +Vs | 10 ... 30 VDC |
| current consumption max. (no load) | 42 mA |
| current consumption typ. | 20 mA |
| voltage drop Vd | < 2 VDC |
| output circuit | PNP |
| output current | < 100 mA |
| short circuit protection | yes |
| reverse polarity protection | yes |

mechanical data

| | |
|------------------|---------------------|
| width / diameter | 8 mm |
| type | cylindrical |
| housing material | brass nickel plated |
| front (optics) | PC |

ambient conditions

| | |
|-----------------------|----------------|
| operating temperature | -25 ... +65 °C |
| protection class | IP 65 |

| order reference | sensing distance Tw | height / length | connection types | output function |
|-------------------|---------------------|-----------------|---------------------|-----------------|
| FZAM 08P1001 | < 40 mm | 56 mm | cable 3 pin, 2 m | light operate |
| FZAM 08P1001/S35L | < 40 mm | 73 mm | connector M8, 3 pin | light operate |
| FZAM 08P1002 | < 80 mm | 56 mm | cable 3 pin, 2 m | light operate |
| FZAM 08P1002/S35L | < 80 mm | 73 mm | connector M8, 3 pin | light operate |
| FZAM 08P3001 | < 40 mm | 56 mm | cable 3 pin, 2 m | dark operate |
| FZAM 08P3001/S35L | < 40 mm | 73 mm | connector M8, 3 pin | dark operate |
| FZAM 08P3002 | < 80 mm | 56 mm | cable 3 pin, 2 m | dark operate |
| FZAM 08P3002/S35L | < 80 mm | 73 mm | connector M8, 3 pin | dark operate |

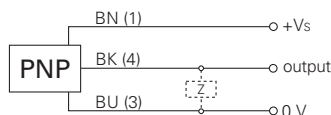
**connection diagram****connectors**

| | | |
|--------------|-------|--------------|
| ESG 32SH0200 | 3 pin | 2 m straight |
| ESW 31SH0200 | 3 pin | 2 m angular |

additional cable connectors and field wireable connectors, see accessories

accessories

| | |
|-----------------------|----------|
| SENSOFIX mounting kit | 10151719 |
|-----------------------|----------|

for details, see accessories section

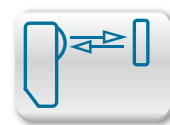

relative receiving signals

Tw < 40 mm

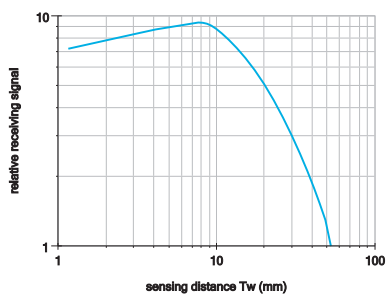

Tw < 80 mm

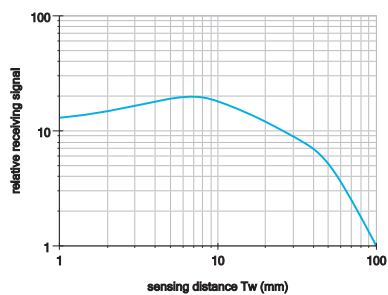

dimension drawings

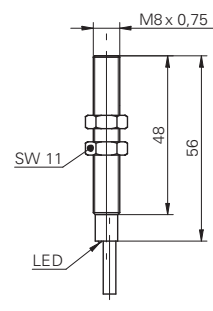
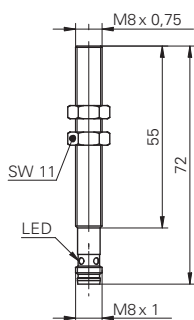

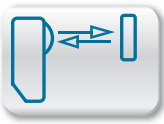

Tw = 5 ... 200 mm



- compact housing
- sensing distance adjustable via potentiometer

general data

| | |
|-------------------------------------|--------------------------|
| type | intensity difference |
| light source | pulsed red LED |
| sensing distance Tw | 5 ... 200 mm |
| alignment / soiled lens indicator | flashing light indicator |
| light indicator | LED yellow |
| sensitivity adjustment | potentiometer, 270° |
| wave length | 660 nm |
| suppression of reciprocal influence | yes |

electrical data

| | |
|------------------------------------|---------------|
| response time / release time | < 1 ms |
| voltage supply range +Vs | 10 ... 30 VDC |
| current consumption max. (no load) | 30 mA |
| current consumption typ. | 20 mA |
| voltage drop Vd | < 1,8 VDC |
| output current | < 100 mA |
| short circuit protection | yes |
| reverse polarity protection | yes |

mechanical data

| | |
|------------------|---------------|
| width / diameter | 10,4 mm |
| height / length | 27 mm |
| depth | 14 mm |
| type | rectangular |
| housing material | plastic (ASA) |
| front (optics) | PMMA |

ambient conditions

| | |
|-----------------------|----------------|
| operating temperature | -25 ... +65 °C |
|-----------------------|----------------|

connection diagrams

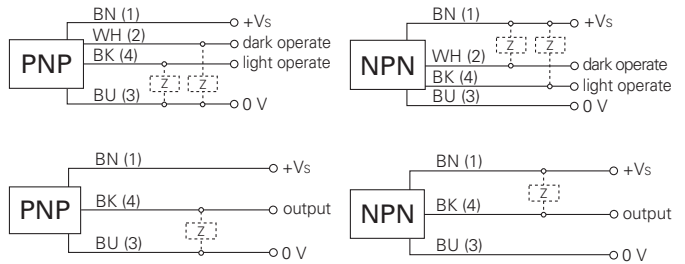

connectors

| | | |
|--------------|-------|--------------|
| ESG 32SH0200 | 3 pin | 2 m straight |
| ESW 31SH0200 | 3 pin | 2 m angular |
| ESG 32AH0200 | 4 pin | 2 m straight |
| ESW 31AH0200 | 4 pin | 2 m angular |

additional cable connectors and field wireable connectors, see accessories

accessories

| | |
|-----------------------------------|----------|
| SENSOFIX mounting kit | 10150326 |
| mounting bracket (cable type) | 10114501 |
| mounting bracket (connector type) | 10133792 |

for details, see accessories section

| order reference | connection types | output circuit | output function | protection class |
|-------------------|----------------------------|----------------|----------------------|------------------|
| FZDK 10N1101/KS35 | flylead connector M8 3 pin | NPN | light operate | IP 65 |
| FZDK 10N5101 | cable 4 pin, 2 m | NPN | light / dark operate | IP 65 |
| FZDK 10N5101/S35A | connector M8 4 pin | NPN | light / dark operate | IP 67 |
| FZDK 10P1101/KS35 | flylead connector M8 3 pin | PNP | light operate | IP 65 |
| FZDK 10P5101 | cable 4 pin, 2 m | PNP | light / dark operate | IP 65 |
| FZDK 10P5101/S35A | connector M8 4 pin | PNP | light / dark operate | IP 67 |

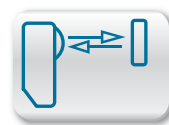

relative receiving signal

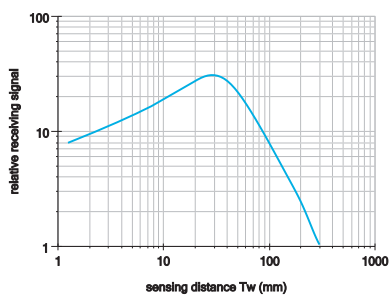

dimension drawings

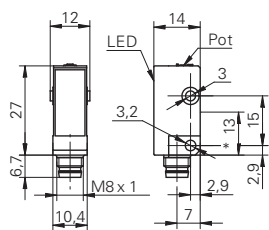

* emitter axis

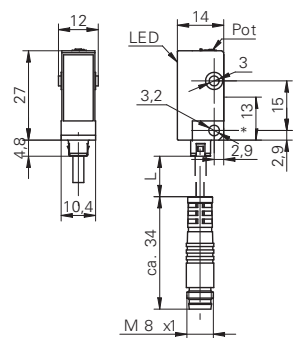

* emitter axis cable length $L = 200$ mm

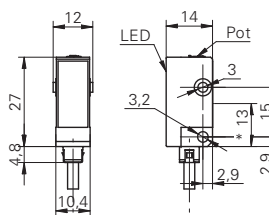

* emitter axis

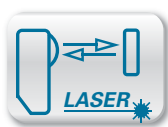

Tw = 3 ... 150 mm

- compact housing
- high repeatability
- very short response time

general data

| | |
|---|-------------------------|
| type | intensity difference |
| light source | pulsed red laser diode |
| sensing distance Tw | 3 ... 150 mm |
| optimum operating distance | 20 ... 40 mm |
| detectable remission difference (on grey) | > 8 % |
| repeat accuracy | < 0,2 mm at laser focus |
| power on indication | LED green |
| light indicator | LED yellow |
| sensitivity adjustment | potentiometer, 5 turn |
| laser class | 2 |
| distance to focus | 40 mm |
| wave length | 650 nm |

electrical data

| | |
|------------------------------------|----------------------|
| response time / release time | < 0,05 ms |
| voltage supply range +Vs | 10 ... 30 VDC |
| current consumption max. (no load) | 50 mA |
| current consumption typ. | 40 mA |
| voltage drop Vd | < 1,8 VDC |
| output function | light / dark operate |
| output current | < 100 mA |
| short circuit protection | yes |
| reverse polarity protection | yes |

mechanical data

| | |
|------------------|---------------|
| width / diameter | 10,4 mm |
| height / length | 27 mm |
| depth | 16,3 mm |
| type | rectangular |
| housing material | plastic (ASA) |
| front (optics) | PMMA |

ambient conditions

| | |
|-----------------------|----------------|
| operating temperature | -10 ... +50 °C |
|-----------------------|----------------|



connection diagrams



connectors

| | | |
|--------------|-------|--------------|
| ESG 32AH0200 | 4 pin | 2 m straight |
| ESW 31AH0200 | 4 pin | 2 m angular |

additional cable connectors and field wireable connectors, see accessories

accessories

| | |
|-----------------------------------|----------|
| SENSOFIX mounting kit | 10150326 |
| mounting bracket (cable type) | 10114501 |
| mounting bracket (connector type) | 10133792 |

for details, see accessories section

laser warning



Complies with 21 CFR 1040.10 and 1040.11 except for deviations pursuant to laser notice No. 50, dated June 24, 2007

| order reference | connection types | output circuit | protection class |
|-------------------|--------------------|----------------|------------------|
| OZDK 10N5101 | cable 4 pin, 2 m | NPN | IP 65 |
| OZDK 10N5101/S35A | connector M8 4 pin | NPN | IP 67 |
| OZDK 10P5101 | cable 4 pin, 2 m | PNP | IP 65 |
| OZDK 10P5101/S35A | connector M8 4 pin | PNP | IP 67 |

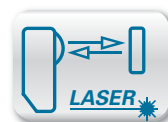

relative receiving signal

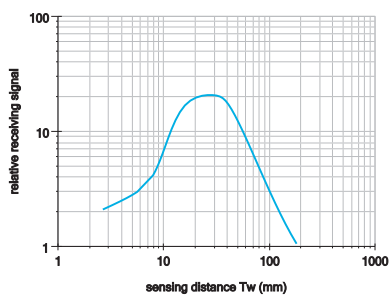

beam characteristic (typically)

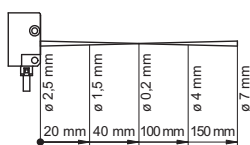

dimension drawings

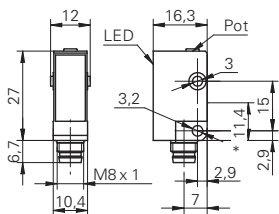

* emitter axis

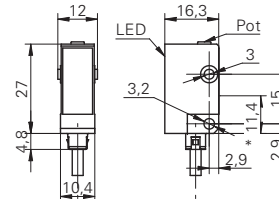

* emitter axis

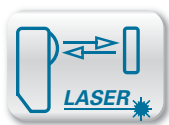

Tw = 3 ... 150 mm

- compact housing
- line beam
- very short response time

general data

| | |
|----------------------------|-------------------------|
| type | intensity difference |
| version | line beam |
| light source | pulsed red laser diode |
| sensing distance Tw | 3 ... 150 mm |
| optimum operating distance | 35 ... 45 mm |
| repeat accuracy | < 0,2 mm at laser focus |
| power on indication | LED green |
| light indicator | LED yellow |
| sensitivity adjustment | potentiometer, 5 turn |
| laser class | 1 |
| distance to focus | 40 mm |
| wave length | 650 nm |

electrical data

| | |
|------------------------------------|----------------------|
| response time / release time | < 0,05 ms |
| voltage supply range +Vs | 10 ... 30 VDC |
| current consumption max. (no load) | 50 mA |
| current consumption typ. | 40 mA |
| voltage drop Vd | < 1,8 VDC |
| output function | light / dark operate |
| output current | < 100 mA |
| short circuit protection | yes |
| reverse polarity protection | yes |

mechanical data

| | |
|------------------|---------------|
| width / diameter | 10,4 mm |
| height / length | 27 mm |
| depth | 16,3 mm |
| type | rectangular |
| housing material | plastic (ASA) |
| front (optics) | PMMA |

ambient conditions

| | |
|-----------------------|----------------|
| operating temperature | -10 ... +50 °C |
|-----------------------|----------------|



connection diagrams



connectors

| | | |
|--------------|-------|--------------|
| ESG 32AH0200 | 4 pin | 2 m straight |
| ESW 31AH0200 | 4 pin | 2 m angular |

additional cable connectors and field wireable connectors, see accessories

accessories

| | |
|-----------------------------------|----------|
| SENSOFIX mounting kit | 10150326 |
| mounting bracket (cable type) | 10114501 |
| mounting bracket (connector type) | 10133792 |

for details, see accessories section

laser warning



Complies with 21 CFR 1040.10 and 1040.11 except for deviations pursuant to laser notice No. 50, dated June 24, 2007

| order reference | connection types | output circuit | protection class |
|-------------------|--------------------|----------------|------------------|
| OZDK 10N5150 | cable 4 pin, 2 m | NPN | IP 65 |
| OZDK 10N5150/S35A | connector M8 4 pin | NPN | IP 67 |
| OZDK 10P5150 | cable 4 pin, 2 m | PNP | IP 65 |
| OZDK 10P5150/S35A | connector M8 4 pin | PNP | IP 67 |

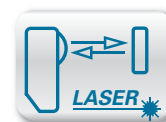

relative receiving signal

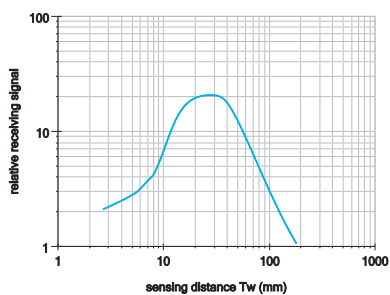

beam characteristic (typically)

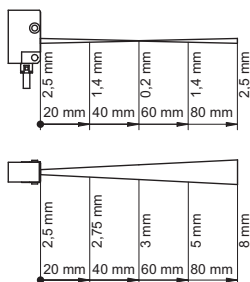

dimension drawings

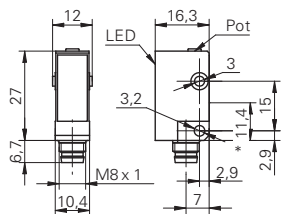

* emitter axis

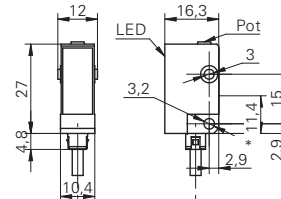

* emitter axis

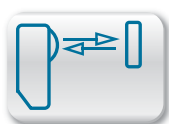

Tw = 30 ... 200 mm

- rugged metal housing
- sensing distance adjustable via potentiometer
- suppression of mutual optical interference

general data

| | |
|-------------------------------------|--------------------------|
| type | intensity difference |
| light source | pulsed infrared diode |
| sensing distance Tw | 30 ... 200 mm |
| alignment / soiled lens indicator | flashing light indicator |
| light indicator | LED yellow |
| sensitivity adjustment | potentiometer, 270° |
| wave length | 880 nm |
| suppression of reciprocal influence | yes |

electrical data

| | |
|------------------------------------|---------------|
| response time / release time | < 1 ms |
| voltage supply range +Vs | 10 ... 30 VDC |
| current consumption max. (no load) | 42 mA |
| current consumption typ. | 24 mA |
| voltage drop Vd | < 1,8 VDC |
| output current | < 200 mA |
| short circuit protection | yes |
| reverse polarity protection | yes |

mechanical data

| | |
|------------------|---------------------|
| width / diameter | 12 mm |
| type | cylindrical |
| housing material | brass nickel plated |
| front (optics) | PC |

ambient conditions

| | |
|-----------------------|----------------|
| operating temperature | -25 ... +65 °C |
| protection class | IP 65 |



connection diagrams

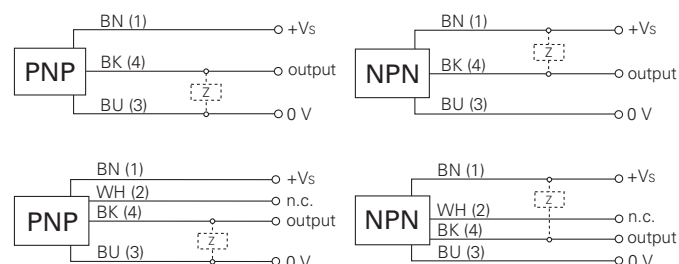

connectors

| | | |
|--------------|-------|--------------|
| ESG 34AH0200 | 4 pin | 2 m straight |
| ESW 33AH0200 | 4 pin | 2 m angular |

additional cable connectors and field wireable connectors, see accessories

accessories

| | |
|-----------------------|----------|
| SENSOFIX mounting kit | 10151720 |
|-----------------------|----------|

for details, see accessories section

| order reference | height / length | connection types | output circuit | output function |
|------------------|-----------------|---------------------|----------------|-----------------|
| FZAM 12N1104 | 70 mm | cable 3 pin, 2 m | NPN | light operate |
| FZAM 12N1104/S14 | 80 mm | connector M12 4 pin | NPN | light operate |
| FZAM 12N3104 | 70 mm | cable 3 pin, 2 m | NPN | dark operate |
| FZAM 12N3104/S14 | 80 mm | connector M12 4 pin | NPN | dark operate |
| FZAM 12P1104 | 70 mm | cable 3 pin, 2 m | PNP | light operate |
| FZAM 12P1104/S14 | 80 mm | connector M12 4 pin | PNP | light operate |
| FZAM 12P3104 | 70 mm | cable 3 pin, 2 m | PNP | dark operate |
| FZAM 12P3104/S14 | 80 mm | connector M12 4 pin | PNP | dark operate |

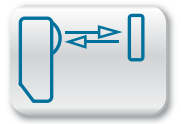

relative receiving signal

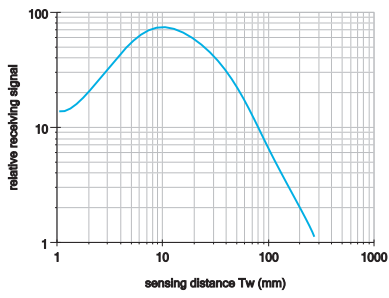

dimension drawings

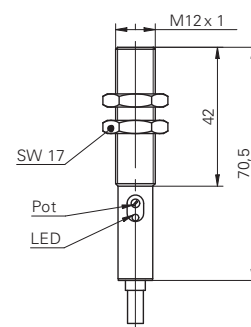
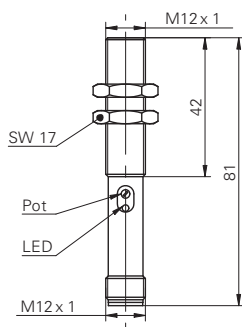

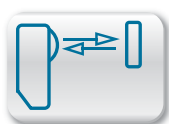

Tw = 5 ... 600 mm

- long range
- sensing distance adjustable via potentiometer
- suppression of mutual optical interference

general data

| | |
|-------------------------------------|--------------------------|
| type | intensity difference |
| light source | pulsed red LED |
| sensing distance Tw | 5 ... 600 mm |
| alignment / soiled lens indicator | flashing light indicator |
| light indicator | LED yellow |
| sensitivity adjustment | potentiometer, 270° |
| wave length | 660 nm |
| suppression of reciprocal influence | yes |

electrical data

| | |
|------------------------------------|----------------------|
| response time / release time | < 1 ms |
| voltage supply range +Vs | 10 ... 30 VDC |
| current consumption max. (no load) | 25 mA |
| current consumption typ. | 20 mA |
| voltage drop Vd | < 1,8 VDC |
| output function | light / dark operate |
| output current | < 100 mA |
| short circuit protection | yes |
| reverse polarity protection | yes |

mechanical data

| | |
|------------------|---------------------|
| width / diameter | 14,8 mm |
| height / length | 43 mm |
| depth | 31 mm |
| type | rectangular |
| housing material | plastic (ASA, MABS) |
| front (optics) | PMMA |

ambient conditions

| | |
|-----------------------|----------------|
| operating temperature | -25 ... +65 °C |
| protection class | IP 67 |

| order reference | connection types | output circuit |
|-------------------|---------------------|----------------|
| FZDK 14N5101 | cable 4 pin, 2 m | NPN |
| FZDK 14N5101/S35A | connector M8 4 pin | NPN |
| FZDK 14P5101 | cable 4 pin, 2 m | PNP |
| FZDK 14P5101/S14 | connector M12 4 pin | PNP |
| FZDK 14P5101/S35A | connector M8 4 pin | PNP |



connection diagrams

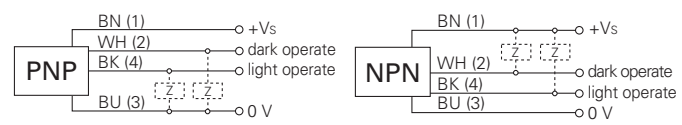

connectors

| | | |
|--------------|-------|--------------|
| ESG 32AH0200 | 4 pin | 2 m straight |
| ESW 31AH0200 | 4 pin | 2 m angular |

additional cable connectors and field wireable connectors, see accessories

accessories

| | |
|-----------------------|----------|
| SENSOFIX mounting kit | 10149011 |
| mounting bracket | 10134964 |

for details, see accessories section

FZDK 14 Tw = 5 ... 600 mm Diffuse sensors with intensity difference

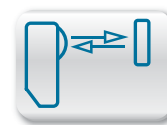

relative receiving signal

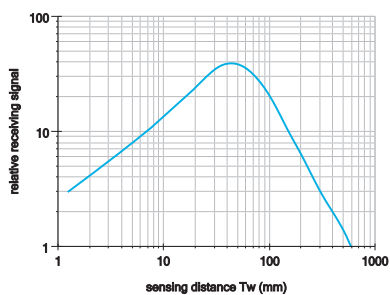

dimension drawings

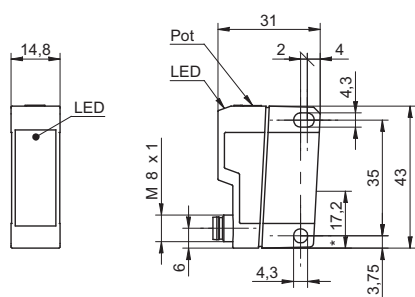

* emitter axis

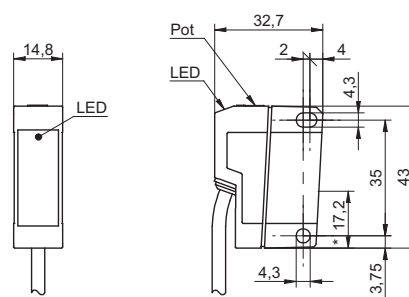

* emitter axis

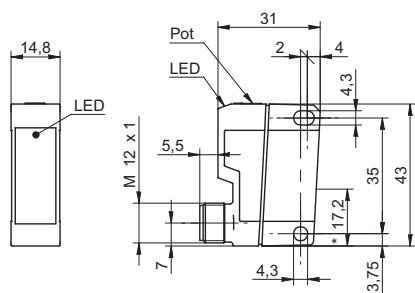

* emitter axis

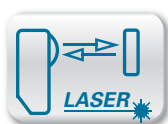

Tw = 20 ... 300 mm

- very short response time
- high repeatability
- sensing distance adjustable via Teach-in

general data

| | |
|-----------------------------------|--------------------------|
| type | intensity difference |
| light source | pulsed red laser diode |
| sensing distance Tw | 20 ... 300 mm |
| repeat accuracy | < 0,2 mm at laser focus |
| alignment / soiled lens indicator | flashing light indicator |
| power on indication | LED green |
| light indicator | LED yellow |
| sensitivity adjustment | Teach-in |
| laser class | 2 |
| distance to focus | 115 mm |
| wave length | 650 nm |

electrical data

| | |
|------------------------------------|---------------|
| response time / release time | < 0,15 ms |
| voltage supply range +Vs | 10 ... 30 VDC |
| current consumption max. (no load) | 35 mA |
| current consumption typ. | 25 mA |
| voltage drop Vd | < 2,2 VDC |
| output function | light operate |
| output current | < 100 mA |
| short circuit protection | yes |
| reverse polarity protection | yes |

mechanical data

| | |
|------------------|---------------------|
| width / diameter | 14,8 mm |
| height / length | 43 mm |
| depth | 31 mm |
| type | rectangular |
| housing material | plastic (ASA, MABS) |
| front (optics) | PMMA |

ambient conditions

| | |
|-----------------------|----------------|
| operating temperature | -10 ... +50 °C |
| protection class | IP 67 |

| order reference | connection types | output circuit |
|-------------------|---------------------|----------------|
| OZDK 14N1901 | cable 4 pin, 2 m | NPN |
| OZDK 14N1901/S14 | connector M12 4 pin | NPN |
| OZDK 14N1901/S35A | connector M8 4 pin | NPN |
| OZDK 14P1901 | cable 4 pin, 2 m | PNP |
| OZDK 14P1901/S14 | connector M12 4 pin | PNP |
| OZDK 14P1901/S35A | connector M8 4 pin | PNP |



connection diagrams



connectors

| | | |
|--------------|-------|--------------|
| ESG 32AH0200 | 4 pin | 2 m straight |
| ESW 31AH0200 | 4 pin | 2 m angular |

additional cable connectors and field wireable connectors, see accessories

accessories

| | |
|-----------------------|----------|
| SENSOFIX mounting kit | 10149011 |
| mounting bracket | 10134964 |

for details, see accessories section

laser warning



Complies with 21 CFR 1040.10 and 1040.11 except for deviations pursuant to laser notice No. 50, dated June 24, 2007

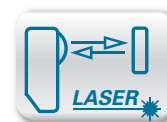

relative receiving signal

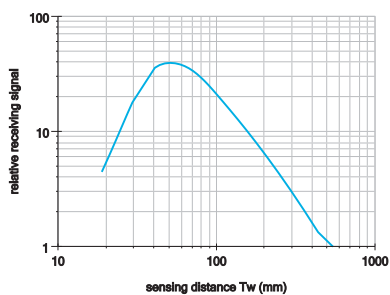

beam characteristic (typically)

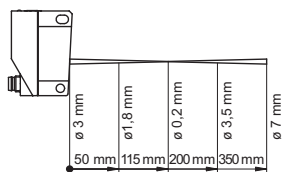

dimension drawings

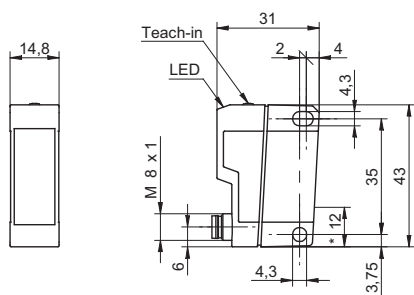

* emitter axis

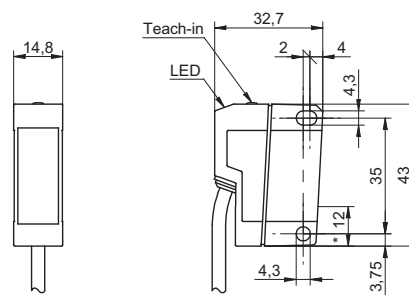

* emitter axis

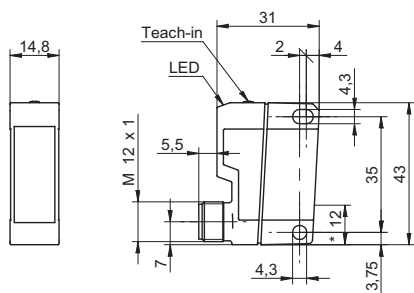

* emitter axis

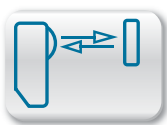

$T_w = 0 \dots 400 \text{ mm}$

- rugged metal housing
- sensing distance adjustable via potentiometer



general data

| | |
|-------------------------------------|--------------------------|
| type | intensity difference |
| light source | pulsed infrared diode |
| sensing distance T_w | 0 ... 400 mm |
| alignment / soiled lens indicator | flashing light indicator |
| light indicator | LED yellow |
| sensitivity adjustment | potentiometer, 270° |
| wave length | 880 nm |
| suppression of reciprocal influence | yes |

electrical data

| | |
|------------------------------------|----------------------|
| response time / release time | < 1 ms |
| voltage supply range +Vs | 10 ... 30 VDC |
| current consumption max. (no load) | 41 mA |
| current consumption typ. | 29 mA |
| voltage drop Vd | < 1,8 VDC |
| output function | light / dark operate |
| output current | < 200 mA |
| short circuit protection | yes |
| reverse polarity protection | yes |

mechanical data

| | |
|------------------|---------------|
| width / diameter | 15,4 mm |
| height / length | 50 mm |
| depth | 50 mm |
| type | rectangular |
| housing material | die-cast zinc |
| front (optics) | PMMA |

ambient conditions

| | |
|-----------------------|----------------|
| operating temperature | -25 ... +65 °C |
| protection class | IP 67 |

| order reference | connection types | output circuit |
|------------------|---------------------|----------------|
| FZDM 16N5101 | cable 4 pin, 2 m | NPN |
| FZDM 16N5101/S14 | connector M12 4 pin | NPN |
| FZDM 16P5101 | cable 4 pin, 2 m | PNP |
| FZDM 16P5101/S14 | connector M12 4 pin | PNP |

connection diagrams



connectors

| | | |
|--------------|-------|--------------|
| ESG 34AH0200 | 4 pin | 2 m straight |
| ESW 33AH0200 | 4 pin | 2 m angular |

additional cable connectors and field wireable connectors, see accessories

accessories

| | |
|-----------------------|----------|
| SENSOFIX mounting kit | 10151721 |
| mounting bracket | 10113917 |

for details, see accessories section

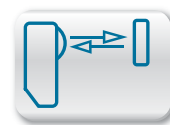

relative receiving signal

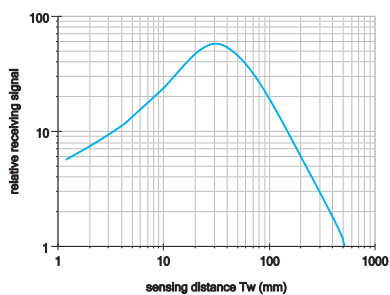

dimension drawings

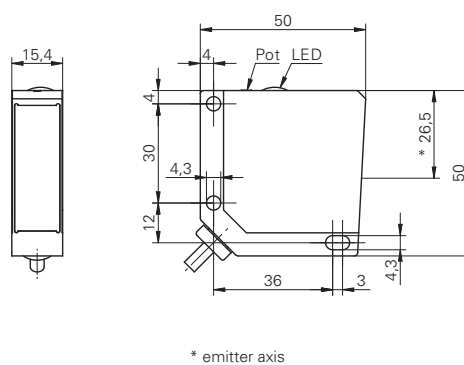
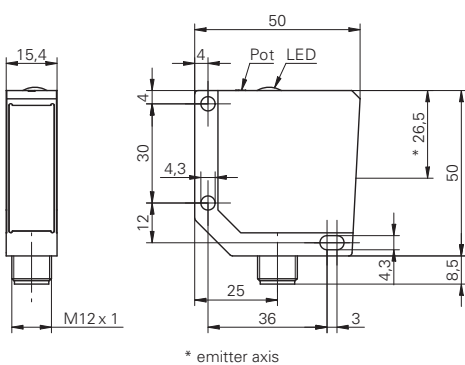

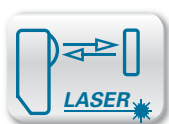

Tw = 0 ... 250 mm

- rugged metal housing
- high repeatability
- very short response time

general data

| | |
|---|-------------------------|
| type | intensity difference |
| light source | pulsed red laser diode |
| sensing distance Tw | 0 ... 250 mm |
| optimum operating distance | 40 ... 80 mm |
| detectable remission difference (on grey) | > 8 % |
| repeat accuracy | < 0,1 mm at laser focus |
| output indicator | LED yellow |
| sensitivity adjustment | potentiometer, 14 turn |
| laser class | 1 |
| distance to focus | 80 mm |
| wave length | 675 nm |

electrical data

| | |
|------------------------------------|---------------|
| response time / release time | < 0,05 ms |
| voltage supply range +Vs | 12 ... 30 VDC |
| current consumption max. (no load) | 65 mA |
| current consumption typ. | 60 mA |
| voltage drop Vd | < 2 VDC |
| output current | < 200 mA |
| short circuit protection | yes |
| reverse polarity protection | yes |

mechanical data

| | |
|------------------|---------------|
| width / diameter | 15,4 mm |
| height / length | 50 mm |
| depth | 50 mm |
| type | rectangular |
| housing material | die-cast zinc |
| front (optics) | glass |

ambient conditions

| | |
|-----------------------|----------------|
| operating temperature | -10 ... +50 °C |
| protection class | IP 67 |



connection diagrams

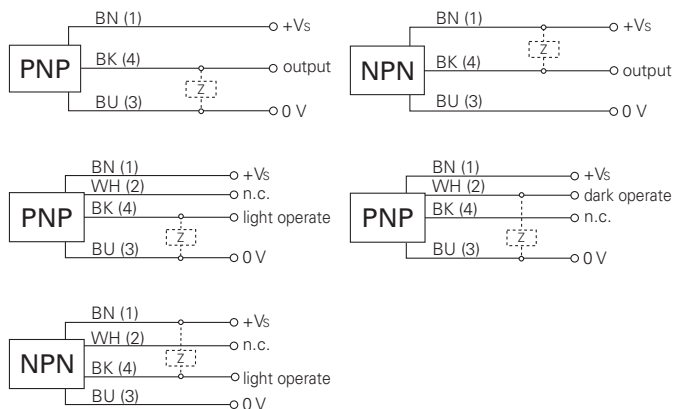

connectors

| | | |
|--------------|-------|--------------|
| ESG 34AH0200 | 4 pin | 2 m straight |
| ESW 33AH0200 | 4 pin | 2 m angular |

additional cable connectors and field wireable connectors, see accessories

accessories

| | |
|----------------------------------|----------|
| SENSOFIX mounting kit | 10151721 |
| mounting bracket | 10113917 |
| lens cleaning air nozzle bracket | 10116407 |

for details, see accessories section

laser warning



Complies with 21 CFR 1040.10 and 1040.11 except for deviations pursuant to laser notice No. 50, dated June 24, 2007

| order reference | connection types | output circuit | output function |
|------------------|---------------------|----------------|-----------------|
| OZDM 16N1001 | cable 3 pin, 2 m | NPN | light operate |
| OZDM 16N1001/S14 | connector M12 4 pin | NPN | light operate |
| OZDM 16P1001 | cable 3 pin, 2 m | PNP | light operate |
| OZDM 16P1001/S14 | connector M12 4 pin | PNP | light operate |
| OZDM 16P3001 | cable 3 pin, 2 m | PNP | dark operate |
| OZDM 16P3001/S14 | connector M12 4 pin | PNP | dark operate |

OZDM 16 Tw = 0 ... 250 mm Diffuse sensors with intensity difference

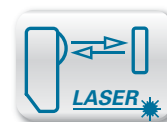

relative receiving signal

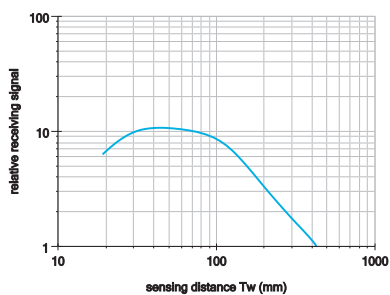

beam characteristic (typically)

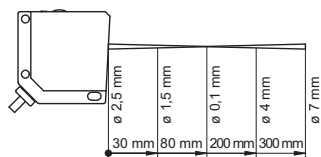

dimension drawings

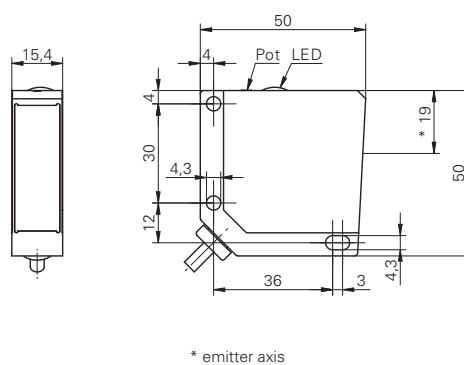
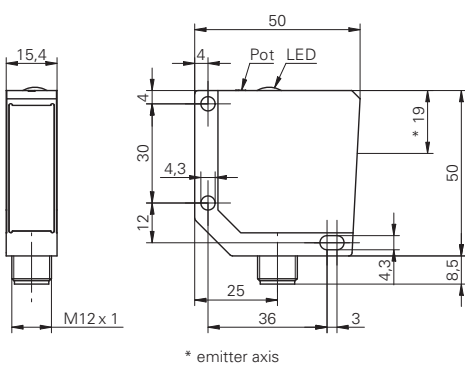

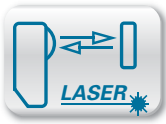

Tw = 0 ... 250 mm

- with analog output
- high repeatability
- very short response time

general data

| | |
|---|-------------------------|
| type | intensity difference |
| light source | pulsed red laser diode |
| sensing distance Tw | 0 ... 250 mm |
| optimum operating distance | 40 ... 80 mm |
| detectable remission difference (on grey) | > 8 % |
| repeat accuracy | < 0,1 mm at laser focus |
| output indicator | LED yellow |
| sensitivity adjustment | potentiometer, 14 turn |
| laser class | 1 |
| distance to focus | 80 mm |
| wave length | 675 nm |

electrical data

| | |
|------------------------------------|--------------------------|
| response time / release time | < 0,1 ms |
| voltage supply range +Vs | 12 ... 30 VDC |
| current consumption max. (no load) | 65 mA |
| current consumption typ. | 60 mA |
| voltage drop Vd | < 2 VDC |
| output function | light operate |
| output circuit | PNP / analog 4 ... 20 mA |
| output current | < 200 mA |
| short circuit protection | yes |
| reverse polarity protection | yes |

mechanical data

| | |
|------------------|---------------|
| width / diameter | 15,4 mm |
| height / length | 50 mm |
| depth | 50 mm |
| type | rectangular |
| housing material | die-cast zinc |
| front (optics) | glass |

ambient conditions

| | |
|-----------------------|----------------|
| operating temperature | -10 ... +50 °C |
| protection class | IP 67 |

order reference **connection types**

| | |
|------------------|---------------------|
| OZDM 16P1901 | cable 4 pin, 2 m |
| OZDM 16P1901/S14 | connector M12 4 pin |



connection diagram

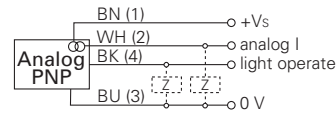

connectors

| | | |
|--------------|-------|--------------|
| ESG 34AH0200 | 4 pin | 2 m straight |
| ESW 33AH0200 | 4 pin | 2 m angular |

additional cable connectors and field wireable connectors, see accessories

accessories

| | |
|----------------------------------|----------|
| SENSOFIX mounting kit | 10151721 |
| mounting bracket | 10113917 |
| lens cleaning air nozzle bracket | 10116407 |

for details, see accessories section

laser warning



Complies with 21 CFR 1040.10 and 1040.11 except for deviations pursuant to laser notice No. 50, dated June 24, 2007

OZDM 16 Tw = 0 ... 250 mm

Diffuse sensors with intensity difference

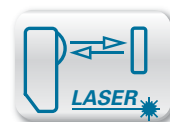

signal progression

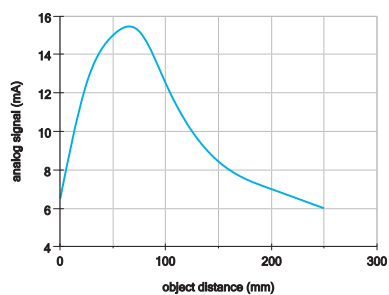

beam characteristic (typically)

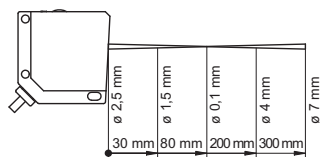

dimension drawings

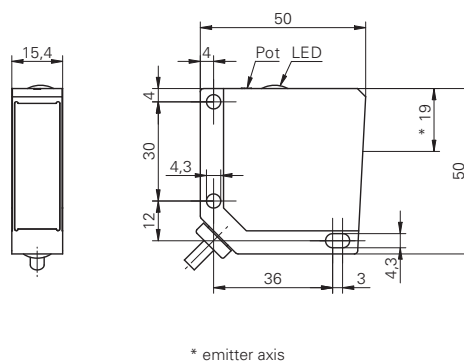
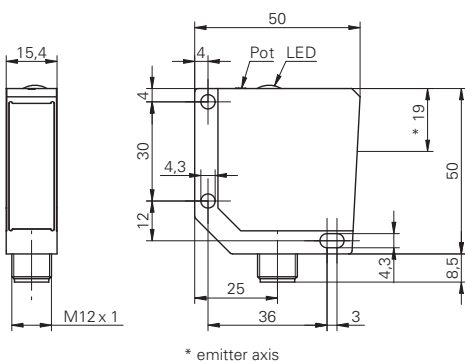

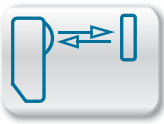

Tw = 60 ... 430 mm

- with alarm output
- sensing distance adjustable via Teach-in
- extended sensing distance with lens

general data

| | |
|---|--------------------------|
| type | intensity difference |
| light source | pulsed infrared diode |
| sensing distance Tw | 60 ... 430 mm |
| sensing distance Tw (with doubling lense) | 80 ... 800 mm |
| alignment / soiled lens indicator | flashing light indicator |
| light indicator | LED green |
| output indicator | LED yellow |
| sensitivity adjustment | Teach-in |
| wave length | 880 nm |
| suppression of reciprocal influence | yes |

electrical data

| | |
|------------------------------------|----------------------------|
| response time / release time | < 1 ms |
| voltage supply range +Vs | 10 ... 30 VDC |
| current consumption max. (no load) | 55 mA |
| current consumption typ. | 40 mA |
| voltage drop Vd | < 1,8 VDC |
| output function | light / dark operate alarm |
| output current | < 200 mA |
| short circuit protection | yes |
| reverse polarity protection | yes |

mechanical data

| | |
|------------------|--------------------------|
| width / diameter | 18 mm |
| type | cylindrical |
| housing material | brass nickel plated / PC |
| front (optics) | PC |

ambient conditions

| | |
|-----------------------|----------------|
| operating temperature | -25 ... +55 °C |
| protection class | IP 67 |



connection diagrams



connectors

| | | |
|--------------|-------|--------------|
| ESG 34AH0200 | 4 pin | 2 m straight |
| ESW 33AH0200 | 4 pin | 2 m angular |

additional cable connectors and field wireable connectors, see accessories

accessories

| | |
|-----------------------|----------|
| SENSOFIX mounting kit | 10151658 |
| glass cover | 10103068 |
| doubling lens | 10107408 |
| cap nut | 10101480 |

for details, see accessories section

remarks

With doubling lens / cap nut, the sensing distance can be doubled.

| order reference | height / length | connection types | output circuit |
|------------------|-----------------|---------------------|----------------|
| FZAM 18N6460 | 50 mm | cable 4 pin, 2 m | NPN |
| FZAM 18N6460/S14 | 60 mm | connector M12 4 pin | NPN |
| FZAM 18P6460 | 50 mm | cable 4 pin, 2 m | PNP |
| FZAM 18P6460/S14 | 60 mm | connector M12 4 pin | PNP |

FZAM 18 Tw = 60 ... 430 mm Diffuse sensors with intensity difference

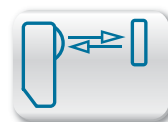

relative receiving signal

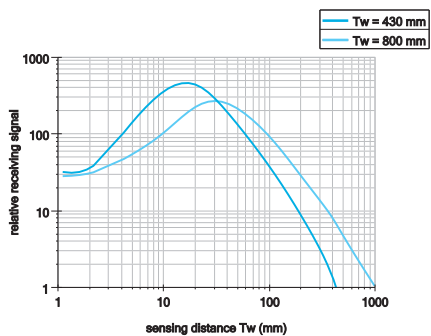

dimension drawings

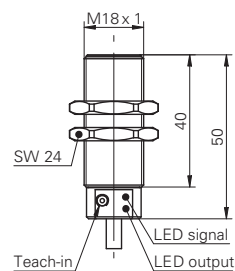
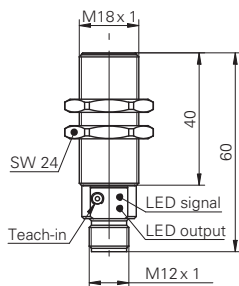

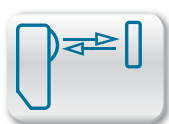

$T_w = 20 \dots 150 \text{ mm}$

- rugged metal housing
- sensing distance adjustable with potentiometer (axial)
- extended sensing distance with lens



general data

| | |
|--|--------------------------|
| type | intensity difference |
| light source | pulsed infrared diode |
| sensing distance T_w | 20 ... 150 mm |
| sensing distance T_w (with doubling lense) | 30 ... 280 mm |
| alignment / soiled lens indicator | flashing light indicator |
| light indicator | LED yellow |
| sensitivity adjustment | potentiometer, 15 turn |
| wave length | 880 nm |
| suppression of reciprocal influence | yes |

electrical data

| | |
|------------------------------------|---------------|
| response time / release time | < 0,5 ms |
| voltage supply range +Vs | 10 ... 30 VDC |
| current consumption max. (no load) | 45 mA |
| current consumption typ. | 30 mA |
| voltage drop Vd | < 1,8 VDC |
| output function | light operate |
| output current | < 200 mA |
| short circuit protection | yes |
| reverse polarity protection | yes |

mechanical data

| | |
|------------------|--------------------------|
| width / diameter | 18 mm |
| height / length | 50 mm |
| type | cylindrical |
| housing material | brass nickel plated / PC |
| front (optics) | PC |
| connection types | cabl 3 pin, 2 m |

ambient conditions

| | |
|-----------------------|----------------|
| operating temperature | -25 ... +55 °C |
| protection class | IP 65 |

order reference

| order reference | output circuit |
|-----------------|----------------|
| FZAM 18N1155 | NPN |
| FZAM 18P1155 | PNP |

connection diagrams

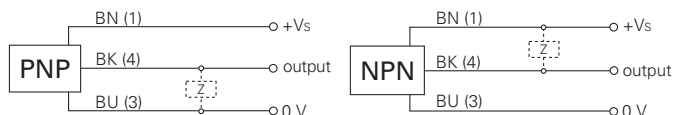

accessories

| | |
|-----------------------|----------|
| SENSOFIX mounting kit | 10151658 |
| glass cover | 10103068 |
| doubling lens | 10107408 |
| cap nut | 10101480 |

for details, see accessories section

remarks

With doubling lens / cap nut, the sensing distance can be doubled.

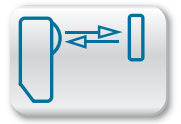

relative receiving signal

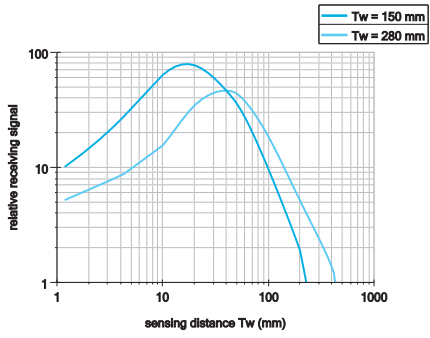

dimension drawing

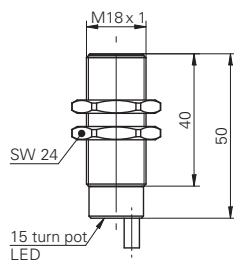

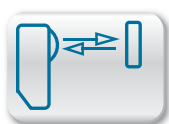

Tw = 60 ... 430 mm

- rugged metal housing
- sensing distance adjustable with radially mounted potentiometer



general data

| | |
|---|--------------------------|
| type | intensity difference |
| light source | pulsed infrared diode |
| sensing distance Tw | 60 ... 430 mm |
| sensing distance Tw (with doubling lense) | 80 ... 800 mm |
| alignment / soiled lens indicator | flashing light indicator |
| light indicator | LED yellow |
| sensitivity adjustment | potentiometer, 270° |
| wave length | 880 nm |
| suppression of reciprocal influence | yes |

electrical data

| | |
|------------------------------------|---------------|
| response time / release time | < 1 ms |
| voltage supply range +Vs | 10 ... 30 VDC |
| current consumption max. (no load) | 45 mA |
| current consumption typ. | 30 mA |
| voltage drop Vd | < 1,8 VDC |
| output function | light operate |
| output current | < 200 mA |
| short circuit protection | yes |
| reverse polarity protection | yes |

mechanical data

| | |
|------------------|--------------------------|
| width / diameter | 18 mm |
| type | cylindrical |
| housing material | brass nickel plated / PC |
| front (optics) | PC |

ambient conditions

| | |
|-----------------------|----------------|
| operating temperature | -25 ... +55 °C |
| protection class | IP 67 |

connection diagrams

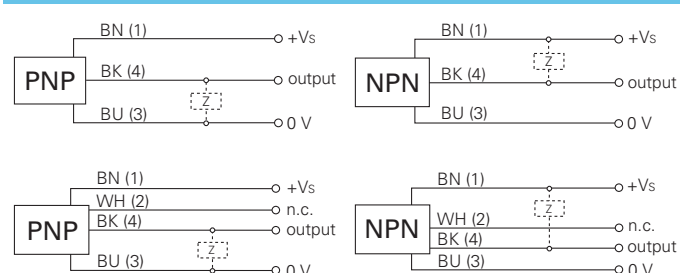

connectors

| | | |
|--------------|-------|--------------|
| ESG 34AH0200 | 4 pin | 2 m straight |
| ESW 33AH0200 | 4 pin | 2 m angular |

additional cable connectors and field wireable connectors, see accessories

accessories

| | |
|------------------------------|----------|
| SENSOFIX mounting kit | 10151658 |
| glass cover | 10103068 |
| doubling lens | 10107408 |
| cap nut | 10101480 |

for details, see accessories section

remarks

With doubling lens / cap nut, the sensing distance can be doubled.

| order reference | height / length | connection types | output circuit |
|-------------------------|-----------------|---------------------|----------------|
| FZAM 18N1150 | 50 mm | cable 3 pin, 2 m | NPN |
| FZAM 18N1150/S14 | 60 mm | connector M12 4 pin | NPN |
| FZAM 18P1150 | 50 mm | cable 3 pin, 2 m | PNP |
| FZAM 18P1150/S14 | 60 mm | connector M12 4 pin | PNP |

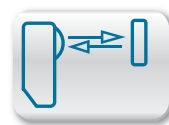

relative receiving signal

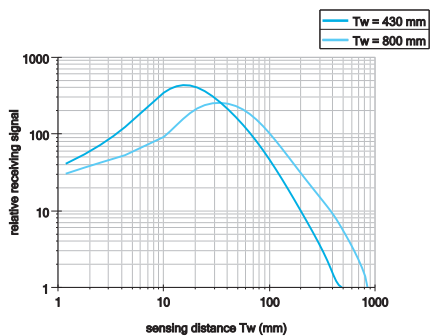

dimension drawings

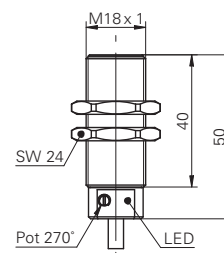
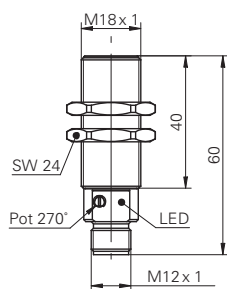

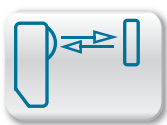

$T_w = 5 \dots 500 \text{ mm}$

- cross-technology housing concept
- sensing distance adjustable via potentiometer
- small mounting depth



general data

| | |
|-------------------------------------|--------------------------|
| type | intensity difference |
| light source | pulsed red LED |
| sensing distance T_w | 5 ... 500 mm |
| alignment / soiled lens indicator | flashing light indicator |
| light indicator | LED yellow |
| sensitivity adjustment | potentiometer, 270° |
| wave length | 660 nm |
| suppression of reciprocal influence | yes |

electrical data

| | |
|------------------------------------|----------------------|
| response time / release time | < 0,5 ms |
| voltage supply range +Vs | 10 ... 30 VDC |
| current consumption max. (no load) | 25 mA |
| current consumption typ. | 22 mA |
| voltage drop Vd | < 1,8 VDC |
| output function | light / dark operate |
| output current | < 100 mA |
| short circuit protection | yes |
| reverse polarity protection | yes |

mechanical data

| | |
|------------------|--------------------|
| width / diameter | 20 mm |
| height / length | 42 mm |
| depth | 15 mm |
| type | rectangular |
| housing material | plastic (PBT-ASA) |
| front (optics) | PMMA |
| connection types | connector M8 4 pin |

ambient conditions

| | |
|-----------------------|----------------|
| operating temperature | -25 ... +65 °C |
| protection class | IP 67 |

order reference

FZDK 20N5101/S35A

output circuit

NPN

FZDK 20P5101/S35A

PNP

connection diagrams



connectors

| | | |
|--------------|-------|--------------|
| ESG 32AH0200 | 4 pin | 2 m straight |
| ESW 31AH0200 | 4 pin | 2 m angular |

additional cable connectors and field wireable connectors, see accessories

accessories

| | |
|-----------------------|----------|
| SENSOFIX mounting kit | 10150326 |
|-----------------------|----------|

for details, see accessories section

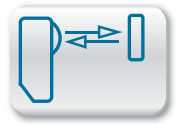

relative receiving signal

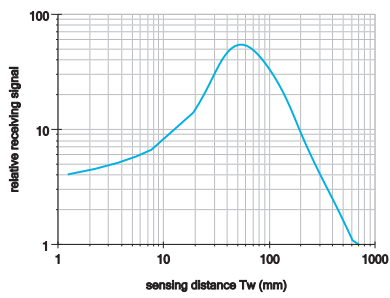

dimension drawing

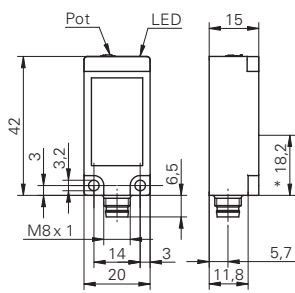

* emitter axis

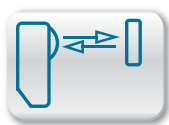

$T_w = 100 \dots 1500 \text{ mm}$

- rugged metal housing
- long sensing range



general data

| | |
|-----------------------------------|--------------------------|
| type | intensity difference |
| light source | pulsed infrared diode |
| alignment / soiled lens indicator | flashing light indicator |
| light indicator | LED yellow |
| sensitivity adjustment | potentiometer, 15 turn |
| wave length | 880 nm |

electrical data

| | |
|------------------------------------|----------------------|
| voltage supply range +Vs | 10 ... 30 VDC |
| current consumption max. (no load) | 60 mA |
| current consumption typ. | 50 mA |
| voltage drop Vd | < 2,5 VDC |
| output function | light / dark operate |
| output current | < 100 mA |
| short circuit protection | yes |
| reverse polarity protection | yes |

mechanical data

| | |
|------------------|---------------------|
| width / diameter | 30 mm |
| height / length | 66 mm |
| type | cylindrical |
| housing material | brass nickel plated |
| front (optics) | PC |
| connection types | cable 4 pin, 2 m |

ambient conditions

| | |
|-----------------------|--------------|
| operating temperature | 0 ... +65 °C |
| protection class | IP 65 |

connection diagrams



accessories

| | |
|---------------|----------|
| glass cover | 10103226 |
| doubling lens | 10107408 |
| cap nut | 10102801 |

for details, see accessories section

| order reference | sensing distance T_w | output circuit | response time / release time |
|-----------------|------------------------|----------------|------------------------------|
| FZAM 30N5002 | 300 ... 1500 mm | NPN | < 2,5 ms |
| FZAM 30P5002 | 300 ... 1500 mm | PNP | < 2,5 ms |
| FZAM 30P5003 | 100 ... 700 mm | PNP | < 0,25 ms |

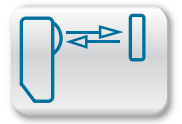

relative receiving signals

Tw = 300 ... 1500 mm

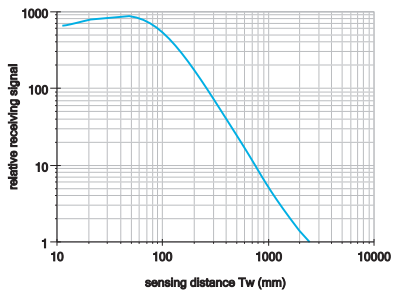



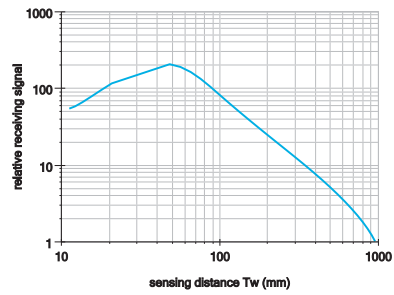

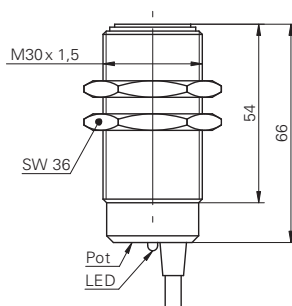

Tw = 100 ... 700 mm



dimension drawing



| product family | FFAK 17 | FFAK 17 | FFAK 16 | FFAM 17 | FFAM 16 | FFDK 16 | FODK 23 |
|------------------------------|---|---|---|---|---|---|---|
| |  |  |  |  |  |  |  |
| type | liquid level sensor | liquid level sensor | liquid level sensor | liquid level sensor | liquid level sensor | liquid level sensor | Leakage sensor |
| width / diameter | 30 mm | 30 mm | 30 mm | 30 mm | 30 mm | 16 mm | 23 mm |
| response time / release time | | | | | | < 2 ms | < 1 ms |
| sensitivity adjustment | no | potentiometer, 15 turn | no | potentiometer, 15 turn | potentiometer, 15 turn | no | no |
| NPN | ■ | ■ | ■ | | | | |
| PNP | ■ | ■ | ■ | ■ | ■ | ■ | ■ |
| cable | ■ | ■ | ■ | ■ | ■ | ■ | ■ |
| thread | G 3/8" | G 3/8" | M16x1 mm | G 3/8" | M16x1 mm | | |
| housing material | plastic | plastic | plastic | metal | metal | plastic | plastic |
| page | 188 | 189 | 190 | 191 | 192 | 193 | 194 |



General information

With photoelectric level monitoring and leak sensors, liquids can be easily and reliably detected without the need of an electrical connection or mechanical movement between the liquid and the sensor. There are two possible principles of detection: the sensor is in direct contact with the liquid or it is fastened to a hose or stand pipe to detect the level without contact. The available fiber optic versions permit level and leak control in constricted surroundings and even in hazardous zones.

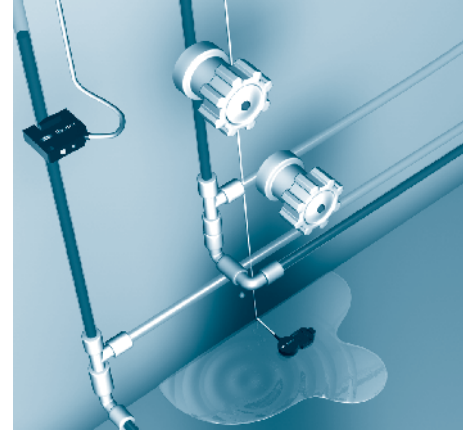

Typical applications

The chemical resistance of the sensors permits versatile applications:

- Level monitoring of liquids such as
 - acetone
 - alkalis
 - milk
 - acids, e.g. hydrochloric, sulfuric or battery acid
 - mineral oil
 - all non-conductive liquids
- Contact free level detection in (semi) transparent hoses and stand pipes
- Detection of the minimum and maximum levels in trays and tanks
- Leak monitoring of oil trays or lubricant tanks
- Monitoring of leaked liquids in dispensers and other liquid handling systems

Characteristics and advantages of level monitoring sensors

Chemical resistance

The sensor housings are made of polysulfonide or stainless steel and are resistant to certain liquids.

Detectable media

As optical light is used to detect the liquid, various and non-conductive liquids can be detected.

Simple commissioning

It is unnecessary to adjust sensors with integrated electronics. With fiber optics, the adjustment is made via a fiber optic sensor.

Hazardous environments

The intrinsically safe fiber optic version with PFA coating can also be used in hazardous environments.

Characteristics and advantages of leak sensors

Detectable media

As optical light is used to detect the liquid, various and non-conductive liquids can be detected. Typically, 1ml of leaked liquid is sufficient to initiate an alarm.

Failsafe facility

The integrated failsafe facility triggers an alarm on leaks, cable rupture, detachment from the fastening or if the sensor is defective.

Hazardous environments

The intrinsically safe fiber optic version with PFA coating can also be used in hazardous environments.



Technology and operation

Level monitoring and leak sensors in contact with the liquid

The operating principles of both types of sensor are shown in the sketch below. The critical angle for total reflection changes depending on whether the sensor tip is surrounded by water or air. If the sensor tip is surrounded by a liquid, the light beam is refracted by the liquid and the sensor output changes its state. The liquid medium may be electrically conductive, turbid or clear. The same operating principle is employed for the leak sensors. Only the volume of the liquid is different. Typically, as little as 1ml of a liquid can be detected.

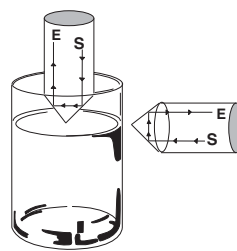

Level not reached



Level reached

Level monitoring sensors without contact with the liquid

The level monitoring sensors for hose or stand pipe mounting operate by a similar principle. For example, the FFDK 16 also exploits the refractive properties of liquids. In a state without the liquid, the emitted light (A) impinges directly on the receiver (B). If the liquid enters the detection range, a part of the emitted light is refracted, so that less light impinges on the receiver. This change in the light can be assessed by the sensor.

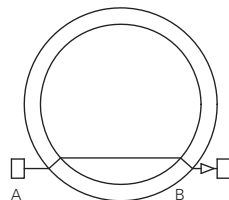

Level not reached

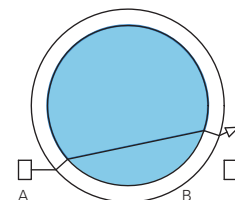

Level reached

With the fiber optic version FSL 500C6Y00, the principle is exactly the opposite. In a state without the liquid, no light impinges on the receiver (B). It is only when liquid enters the detection range of the array that a part of the emitted light (A) is diverted to the receiver (B). This change in the light can be assessed by the receiver. The advantage of the array configuration with a monitoring range of approx. 5 mm is that interference caused by foam and small air bubbles can be suppressed by a powerful fiber optic sensor.

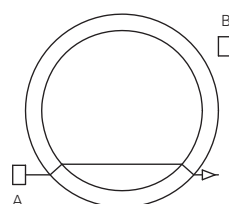

Level not reached

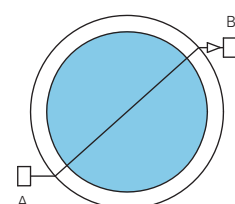

Level reached



Mounting and adjustment

Level monitoring sensors for hose/stand pipe mounting:

The sensors can very easily be attached to a hose or stand pipe with cable ties. A separate bracket or other holder is unnecessary. No adjustments must be made to the FFDK 16 with integrated electronics. It is only necessary to choose between light and dark switching. With the fiber optic version FSL, the adjustment is made via a fiber optic sensor.

Leak sensors:

The leak sensors can be screwed directly to the floor or on a base. No adjustments must be made to the sensor FODK 23. With the fiber optic version FOC, the adjustment is made via a fiber optic sensor. The sensors can be very easily released from their holders for cleaning purposes move to beginning of sentence.

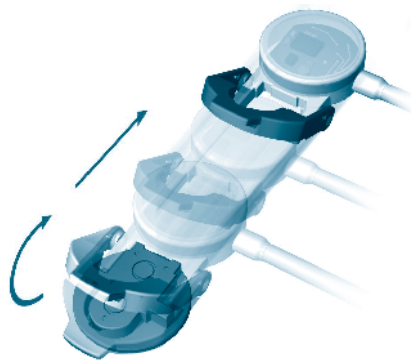



- chemical resistance
- up to 10 bar nominal pressure

general data

| | |
|------------------------------|-----------------------|
| type | liquid level sensor |
| light source | pulsed infrared diode |
| nominal pressure (probe tip) | 10 bar |
| output indicator | LED yellow |
| sensitivity adjustment | no |
| wave length | 880 nm |
| measurement type | contact with medium |

electrical data

| | |
|------------------------------------|--------------------|
| voltage supply range +Vs | 10 ... 30 VDC |
| current consumption max. (no load) | 15 mA |
| voltage drop Vd | < 2 VDC |
| output function | normally open (NO) |
| output current | < 200 mA |
| short circuit protection | no |
| reverse polarity protection | yes, Vs to GND |

mechanical data

| | |
|---------------------------|------------------|
| width / diameter | 30 mm |
| height / length | 81 mm |
| thread | G 3/8" |
| type | cylindrical |
| material (sensing device) | polysulphone |
| housing material | polysulphone |
| connection types | cable 3 pin, 2 m |

ambient conditions

| | |
|-----------------------|--------------|
| operating temperature | 0 ... +65 °C |
| protection class | IP 67 |

| order reference | output circuit |
|-----------------|----------------|
|-----------------|----------------|

| | |
|------------------|-----|
| FFAK 17NTD1001/L | NPN |
| FFAK 17PTD1001/L | PNP |



dimension drawing

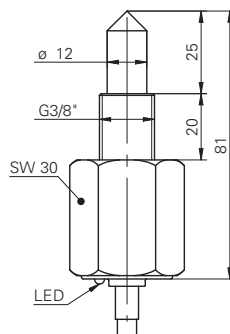

connection diagrams

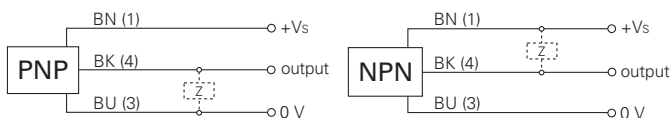

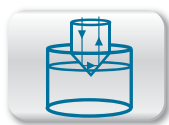

- sensitivity adjustable
- chemical resistance
- up to 10 bar nominal pressure

general data

| | |
|------------------------------|------------------------|
| type | liquid level sensor |
| light source | pulsed infrared diode |
| nominal pressure (probe tip) | 10 bar |
| output indicator | LED yellow |
| sensitivity adjustment | potentiometer, 15 turn |
| wave length | 880 nm |
| measurement type | contact with medium |

electrical data

| | |
|------------------------------------|--------------------|
| voltage supply range +Vs | 10 ... 30 VDC |
| current consumption max. (no load) | 15 mA |
| voltage drop Vd | < 2 VDC |
| output function | normally open (NO) |
| output current | < 200 mA |
| short circuit protection | no |
| reverse polarity protection | yes, Vs to GND |

mechanical data

| | |
|---------------------------|------------------|
| width / diameter | 30 mm |
| height / length | 81,5 mm |
| thread | G 3/8" |
| type | cylindrical |
| material (sensing device) | polysulphone |
| housing material | polysulphone |
| connection types | cable 3 pin, 2 m |

ambient conditions

| | |
|-----------------------|--------------|
| operating temperature | 0 ... +65 °C |
| protection class | IP 67 |

order reference

| |
|------------------|
| FFAK 17NTD1002/L |
| FFAK 17PTD1002/L |

output circuit

| |
|-----|
| NPN |
| PNP |



dimension drawing

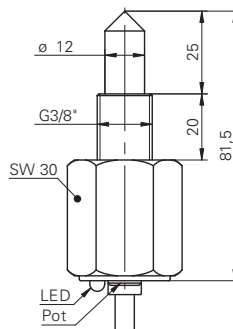

connection diagrams

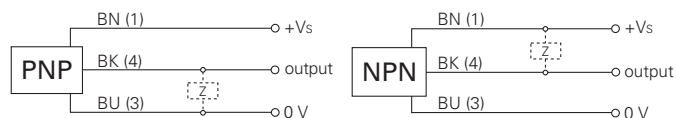



- with thread M16x1
- chemical resistance
- up to 10 bar nominal pressure

general data

| | |
|------------------------------|-----------------------|
| type | liquid level sensor |
| light source | pulsed infrared diode |
| nominal pressure (probe tip) | 10 bar |
| output indicator | LED yellow |
| sensitivity adjustment | no |
| wave length | 880 nm |
| measurement type | contact with medium |

electrical data

| | |
|------------------------------------|--------------------|
| voltage supply range +Vs | 10 ... 30 VDC |
| current consumption max. (no load) | 15 mA |
| voltage drop Vd | < 2 VDC |
| output function | normally open (NO) |
| output current | < 200 mA |
| short circuit protection | no |
| reverse polarity protection | yes, Vs to GND |

mechanical data

| | |
|---------------------------|------------------|
| width / diameter | 30 mm |
| height / length | 81 mm |
| thread | M16x1 mm |
| type | cylindrical |
| material (sensing device) | polysulphone |
| housing material | polysulphone |
| connection types | cable 3 pin, 2 m |

ambient conditions

| | |
|-----------------------|--------------|
| operating temperature | 0 ... +65 °C |
| protection class | IP 67 |

| order reference | output circuit |
|-----------------|----------------|
|-----------------|----------------|

| | |
|------------------|-----|
| FFAK 16NTD1001/L | NPN |
| FFAK 16PTD1001/L | PNP |



dimension drawing

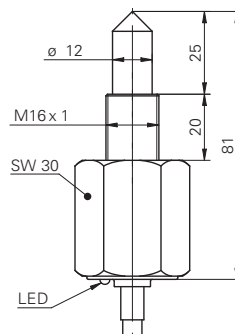

connection diagrams

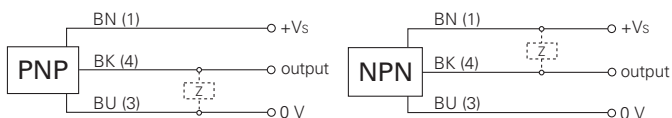

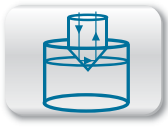

- rugged metal housing
- chemical resistance
- up to 40 bar nominal pressure



general data

| | |
|------------------------------|------------------------|
| type | liquid level sensor |
| light source | pulsed infrared diode |
| nominal pressure (probe tip) | 40 bar |
| output indicator | LED yellow |
| sensitivity adjustment | potentiometer, 15 turn |
| wave length | 880 nm |
| measurement type | contact with medium |

electrical data

| | |
|------------------------------------|--------------------|
| voltage supply range +Vs | 10 ... 30 VDC |
| current consumption max. (no load) | 15 mA |
| voltage drop Vd | < 2 VDC |
| output function | normally open (NO) |
| output circuit | PNP |
| output current | < 200 mA |
| short circuit protection | no |
| reverse polarity protection | yes, Vs to GND |

mechanical data

| | |
|---------------------------|-------------------------------------|
| width / diameter | 30 mm |
| height / length | 66,5 mm |
| thread | G 3/8" |
| type | cylindrical |
| material (sensing device) | glass (borosilicate) |
| housing material | stainless steel DIN 1.4305/AISI 303 |
| connection types | cable 3 pin, 2 m |

ambient conditions

| | |
|-----------------------|--------------|
| operating temperature | 0 ... +65 °C |
| protection class | IP 67 |

order reference

FFAM 17PTD1002/L

dimension drawing

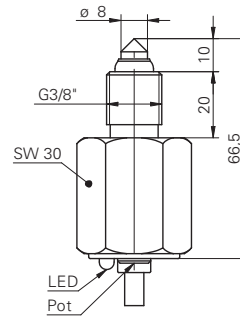

connection diagram

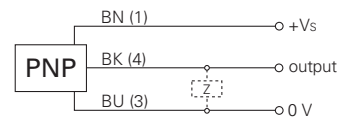



- with thread M16x1
- rugged metal housing
- up to 40 bar nominal pressure

general data

| | |
|------------------------------|------------------------|
| type | liquid level sensor |
| light source | pulsed infrared diode |
| nominal pressure (probe tip) | 40 bar |
| output indicator | LED yellow |
| sensitivity adjustment | potentiometer, 15 turn |
| wave length | 880 nm |
| measurement type | contact with medium |

electrical data

| | |
|------------------------------------|--------------------|
| voltage supply range +Vs | 10 ... 30 VDC |
| current consumption max. (no load) | 15 mA |
| voltage drop Vd | < 2 VDC |
| output function | normally open (NO) |
| output circuit | PNP |
| output current | < 200 mA |
| short circuit protection | no |
| reverse polarity protection | yes, Vs to GND |

mechanical data

| | |
|---------------------------|-------------------------------------|
| width / diameter | 30 mm |
| height / length | 66,5 mm |
| thread | M16x1 mm |
| type | cylindrical |
| material (sensing device) | glass (borosilicate) |
| housing material | stainless steel DIN 1.4305/AISI 303 |
| connection types | cable 3 pin, 2 m |

ambient conditions

| | |
|-----------------------|--------------|
| operating temperature | 0 ... +65 °C |
| protection class | IP 67 |

order reference

FFAM 16PTD1002/L



dimension drawing

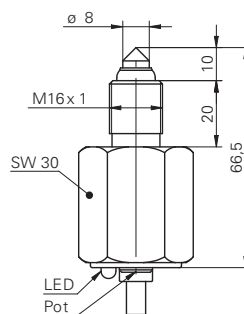

connection diagram



- liquid level sensor for pipe mounting
- pipe diameter from 3 ... 13 mm
- easy setup - no adjustment necessary



general data

| | |
|-----------------------------------|-----------------------|
| type | liquid level sensor |
| light source | pulsed infrared diode |
| output indicator | LED red |
| sensitivity adjustment | no |
| wave length | 950 nm |
| max. thickness of the pipe / tube | 1 mm |

electrical data

| | |
|------------------------------------|---------------------------------|
| response time / release time | < 2 ms |
| current consumption max. (no load) | 25 mA |
| voltage drop Vd | < 1 VDC |
| output function | light / dark operate switchable |
| output circuit | PNP |
| output current | < 100 mA |
| short circuit protection | yes |
| reverse polarity protection | yes |

mechanical data

| | |
|------------------|------------------|
| width / diameter | 16 mm |
| height / length | 28 mm |
| depth | 26 mm |
| type | rectangular |
| housing material | PC |
| connection types | cable 3 pin, 2 m |

ambient conditions

| | |
|-----------------------|----------------|
| operating temperature | -10 ... +55 °C |
| protection class | IP 50 |

dimension drawing

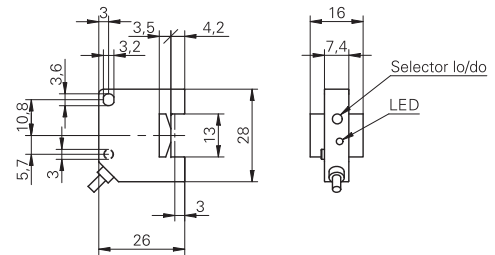

connection diagram

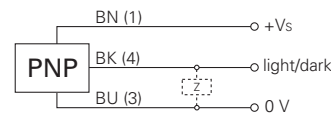

| order reference | voltage supply range +Vs | max. outer diameter of the pipe / tube |
|-----------------|--------------------------|--|
| FFDK 16P50Y0 | 9 ... 30,8 VDC | 8 ... 13 mm |
| FFDK 16P50Y5 | 10 ... 30 VDC | 3 ... 7 mm |

- leakage sensor with integrated electronics
- detects liquid amounts of approx. 1 ml
- chemical resistance thanks to PFA sheath



general data

| | |
|------------------------|---------------------|
| type | Leakage sensor |
| light source | pulsed red LED |
| output indicator | LED orange |
| light indicator | LED green |
| sensitivity adjustment | no |
| wave length | 875 nm |
| measurement type | contact with medium |

electrical data

| | |
|------------------------------------|----------------------|
| response time / release time | < 1 ms |
| voltage supply range +Vs | 12 ... 24 VDC |
| current consumption max. (no load) | 30 mA |
| voltage drop Vd | < 1 VDC |
| output function | normally closed (NC) |
| output circuit | PNP |
| output current | < 50 mA |
| short circuit protection | yes |
| reverse polarity protection | yes |

mechanical data

| | |
|---------------------------|-------------|
| width / diameter | 23 mm |
| height / length | 10,5 mm |
| depth | 37,2 mm |
| type | rectangular |
| material (sensing device) | PFA |

ambient conditions

| | |
|-----------------------|----------------|
| operating temperature | -25 ... +50 °C |
| protection class | IP 67 |

accessories

| | |
|-------------------|--|
| mounting clip PVC | |
| mounting clip PFA | |
| on request | |

| order reference | housing material | connection types |
|-------------------|------------------|------------------|
| FODK 23P90Y0 | PFA / PVC | cable 3 pin, 2 m |
| FODK 23P90Y0/0500 | PFA / PVC | cable 3 pin, 5 m |
| FODK 23P90Y5 | PFA | cable 3 pin, 2 m |

dimension drawings

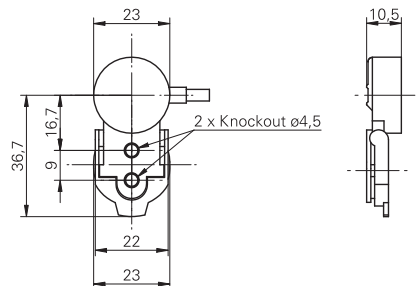

FODK 23P90Y0...

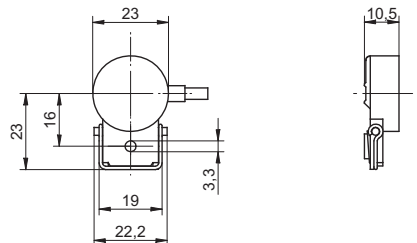

FODK 23P90Y5

connection diagram

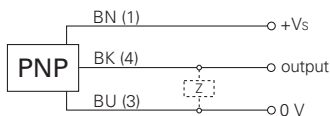

Fiber optic level sensor FUL

- the special sensor tip prevents drop formation
- high chemical resistance

| general data | |
|------------------------|---|
| type | liquid level sensor |
| optical fiber length | 2 m / 5 m |
| mechanical data | |
| min. bending radius | 30 mm |
| tensile strength | 5 N |
| optical fiber material | PFA |
| ambient conditions | |
| operating temperature | -30 ... +105 °C |
| order reference | |
| FUL 200D2Y00 | (use with fiber optic sensor FVDK 66 / FVDK 67) |
| FUL 500D2Y00 | (use with fiber optic sensor FVDK 66 / FVDK 67) |

dimension drawing

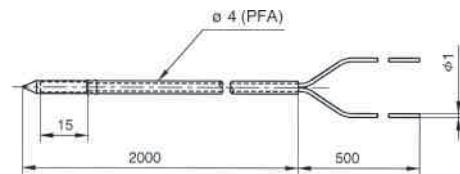

R = 15 mm / 30 mm tip to 40 mm length

Fiber optic level sensor for stand pipe mounting FSL

- fine light curtain suppresses foam/air bubbles
- diameter of the pipe/tube 3 ... 13 mm

| general data | |
|--------------------------------------|---|
| type | liquid level sensor |
| optical fiber length | 5 m |
| max. outer diameter of the pipe/tube | 3 ... 13 mm |
| max. thickness of the pipe/tube | 1 mm |
| mechanical data | |
| min. bending radius | 4 mm |
| tensile strength | 20 N |
| optical fiber material | PMMA, PFA coated |
| housing material | PEI / PC |
| ambient conditions | |
| operating temperature | -30 ... +70 °C |
| order reference | |
| FSL 500C6Y00 | (use with fiber optic sensor FVDK 66 / FVDK 67) |

dimension drawing

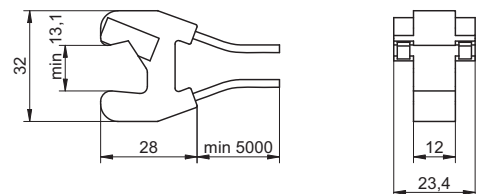

Fiber optic leak sensor FOC

- detects typical liquid volumes of 1 ml
- high chemical resistance

| general data | |
|------------------------|---|
| type | leakage sensor |
| optical fiber length | 5 m |
| mechanical data | |
| min. bending radius | 20 mm |
| tensile strength | 10 N |
| optical fiber material | PE, PFA coated |
| housing material | PFA |
| ambient conditions | |
| operating temperature | -30 ... +70 °C |
| order reference | |
| FOC 500C6Y00 | (use with fiber optic sensor FVDK 66 / FVDK 67) |

dimension drawing

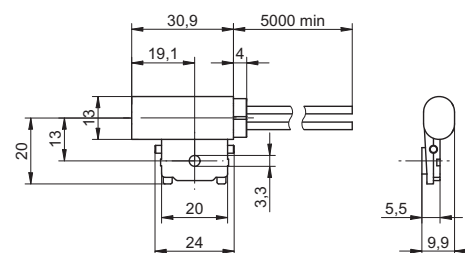



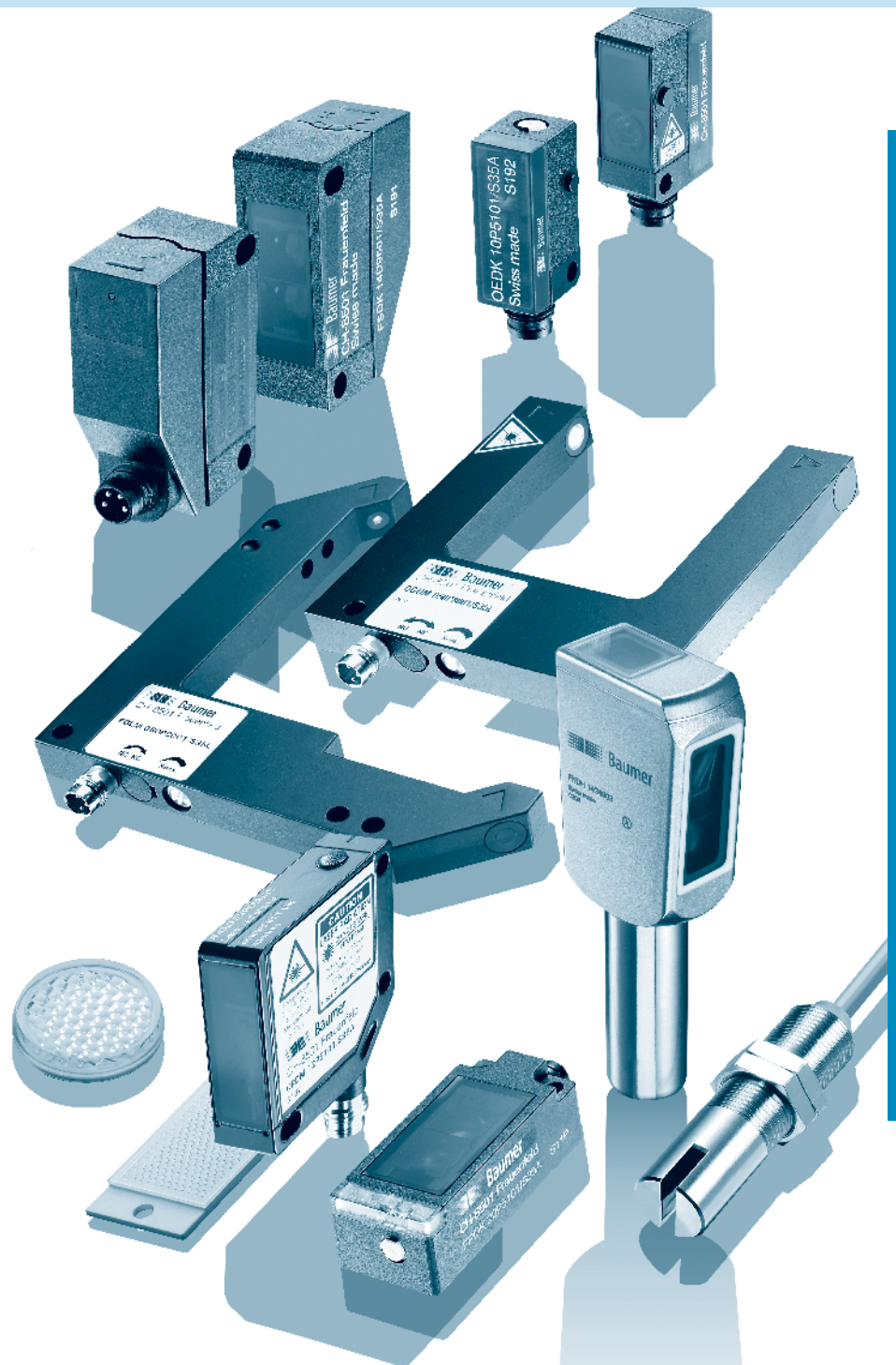

Light barriers



SmartReflect Light barriers
Retro-reflective sensors
Through beam sensors
Fork and angle sensors

Page 198
Page 214
Page 250
Page 282

red light LED version

| product family | FNCK 07 | FNDK 07 | FNDK 14 | FNDH 14 | FNDR 14 |
|------------------------------|---|---|---|---|---|
| |  |  |  |  |  |
| version | MINOS | MINOS | Tray and bottle detection Foil detection standard object detection | standard object detection Tray and bottle detection Foil detection | standard object detection Tray and bottle detection Foil detection |
| width / diameter | 8 mm | 8 mm | 14,8 mm | 19,6 mm | 19,6 mm |
| response time / release time | < 0,5 ms | < 0,5 ms | < 1,8 ms | < 1,8 ms | < 1,8 ms |
| sensing distance adjustment | Teach-in | Teach-in | Teach-in and IO-Link | Teach-in Teach-in and IO-Link | Teach-in Teach-in and IO-Link |
| push-pull | | | ■ | ■ | ■ |
| NPN | ■ | ■ | | | |
| PNP | ■ | ■ | | | |
| cable | ■ | ■ | | ■ | |
| flylead connector | ■ | ■ | | ■ | |
| connector | | | ■ | | ■ |
| housing material | plastic | plastic | plastic | metal | metal |
| | | | IO-Link | IO-Link | IO-Link |
| page | 202 | 204 | 206 | 208 | 210 |

laser version

| product family | ONDK 25 |
|------------------------------|---|
| |  |
| version | standard object detection |
| width / diameter | 23,4 mm |
| response time / release time | < 10 ms |
| sensing distance adjustment | Teach-in |
| push-pull | ■ |
| connector | ■ |
| housing material | plastic |
| page | 212 |



General information

SmartReflect light barriers offer the safest and most convenient type of object detection.

Applications

- If there is no room for the installation of a separate receiver or reflector
- If cleaning agents could damage the reflector

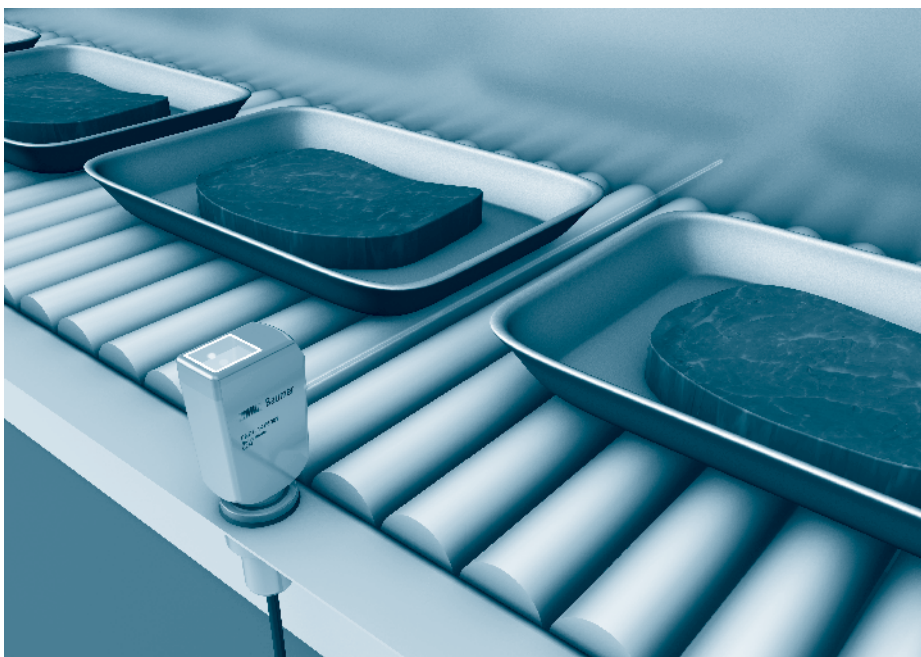

Characteristics and advantages

Maximum security

- Most secure object detection due to the barrier principle
- Higher process reliability by eliminating the reflector as the weak spot
- No functional impairment due to contamination

Reduced operating costs

- Time savings during installation, as no separate reflector / receiver is necessary
- No regular reflector exchange necessary
- Expensive reflector cleaning not required



Technology and operation



Contrary to diffuse or through beam sensors, SmartReflect light barriers feature a closed light beam which is set up between the sensor and machine. The sensor switches when an object interrupts the light beam. The only requirement is the presence of a defined background, e.g. a machine part, within the sensing range of the sensor, which closes the light beam.

Mounting and adjustment

The SmartReflect light barrier has to be aligned with a machine part within its sensing range. This machine part is then set using the teach-in.

It should be noted that there is a dead band directly in front of the machine part that is set automatically during teach-in. The dead band is determined by the specification of the sensing range (Sa) as a percentage (%) of the background position (Sde).

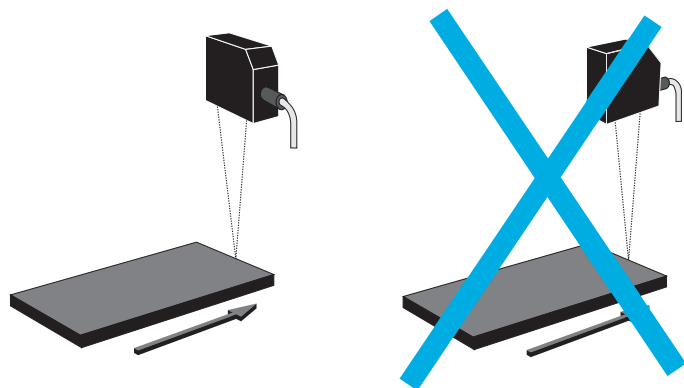

It should be noted that an object to be detected must approach the active range of the sensor from the side in order to avoid switching errors.

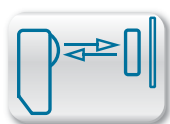

Tw = 10 ... 45 mm

- ultra compact housing with cable rear side
- sensing distance adjustable via Teach-in
- suppression of mutual optical interference

general data

| | |
|-------------------------------------|----------------|
| type | light barrier |
| light source | pulsed red LED |
| background position Sde | 17 ... 45 mm |
| scanning range sa | 82% Sde |
| light indicator | LED green |
| output indicator | LED yellow |
| sensing distance adjustment | Teach-in |
| wave length | 660 nm |
| suppression of reciprocal influence | yes |

electrical data

| | |
|------------------------------------|----------------------|
| response time / release time | < 0,5 ms |
| voltage supply range +Vs | 10 ... 30 VDC |
| current consumption max. (no load) | 25 mA |
| current consumption typ. | 20 mA |
| voltage drop Vd | < 1,8 VDC |
| output function | light / dark operate |
| output current | < 100 mA |
| short circuit protection | yes |
| reverse polarity protection | yes |

mechanical data

| | |
|------------------|--------------------------|
| width / diameter | 8 mm |
| height / length | 16,2 mm |
| depth | 10,8 mm |
| type | rectangular |
| housing material | plastic (PMMA, MABS, PA) |
| front (optics) | PMMA |

ambient conditions

| | |
|-----------------------|----------------|
| operating temperature | -20 ... +50 °C |
| protection class | IP 65 |

| order reference | connection types | output circuit |
|--------------------|----------------------------|----------------|
| FNCK 07N6910 | cable rear side, 2 m | NPN |
| FNCK 07N6910/KS35A | flylead connector M8 4 pin | NPN |
| FNCK 07P6910 | cable rear side, 2 m | PNP |
| FNCK 07P6910/KS35A | flylead connector M8 4 pin | PNP |



connection diagrams



connectors

| | | |
|--------------|-------|--------------|
| ESG 32AH0200 | 4 pin | 2 m straight |
| ESW 31AH0200 | 4 pin | 2 m angular |

additional cable connectors and field wireable connectors, see accessories

accessories

| | |
|----------------------|----------|
| MINOFIX mounting kit | 10150844 |
|----------------------|----------|

for details, see accessories section

FNCK 07 Tw = 10 ... 45 mm

MINOS

SmartReflect Light barriers

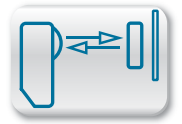

dimension drawings

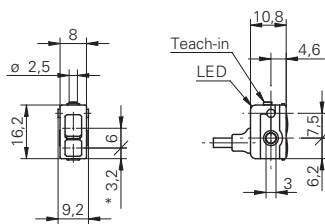

* emitter axis

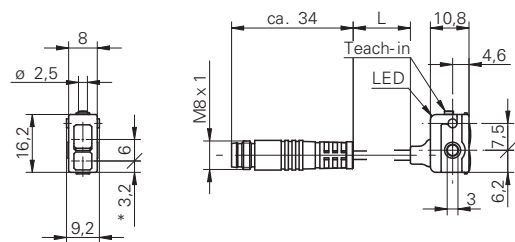

* emitter axis cable length L = 200 mm

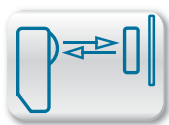

Tw = 10 ... 45 mm

- ultra compact housing with cable bottom side
- sensing distance adjustable via Teach-in
- suppression of mutual optical interference

general data

| | |
|-------------------------------------|----------------|
| type | light barrier |
| light source | pulsed red LED |
| background position Sde | 17 ... 45 mm |
| scanning range sa | 82% Sde |
| light indicator | LED green |
| output indicator | LED yellow |
| sensing distance adjustment | Teach-in |
| wave length | 660 nm |
| suppression of reciprocal influence | yes |

electrical data

| | |
|------------------------------------|----------------------|
| response time / release time | < 0,5 ms |
| voltage supply range +Vs | 10 ... 30 VDC |
| current consumption max. (no load) | 25 mA |
| current consumption typ. | 20 mA |
| voltage drop Vd | < 1,8 VDC |
| output function | light / dark operate |
| output current | < 100 mA |
| short circuit protection | yes |
| reverse polarity protection | yes |

mechanical data

| | |
|------------------|--------------------------|
| width / diameter | 8 mm |
| height / length | 16,2 mm |
| depth | 10,8 mm |
| type | rectangular |
| housing material | plastic (PMMA, MABS, PA) |
| front (optics) | PMMA |

ambient conditions

| | |
|-----------------------|----------------|
| operating temperature | -20 ... +50 °C |
| protection class | IP 65 |

| order reference | connection types | output circuit |
|--------------------|----------------------------|----------------|
| FNDK 07N6910 | cable bottom side, 2 m | NPN |
| FNDK 07N6910/KS35A | flylead connector M8 4 pin | NPN |
| FNDK 07P6910 | cable bottom side, 2 m | PNP |
| FNDK 07P6910/KS35A | flylead connector M8 4 pin | PNP |



connection diagrams



connectors

| | | |
|--------------|-------|--------------|
| ESG 32AH0200 | 4 pin | 2 m straight |
| ESW 31AH0200 | 4 pin | 2 m angular |

additional cable connectors and field wireable connectors, see accessories

accessories

| | |
|----------------------|----------|
| MINOFIX mounting kit | 10150844 |
|----------------------|----------|

for details, see accessories section

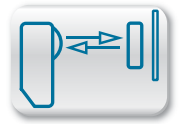

dimension drawings

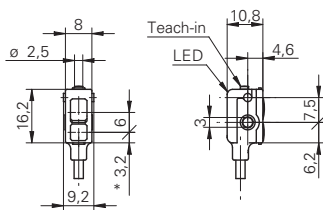

* emitter axis

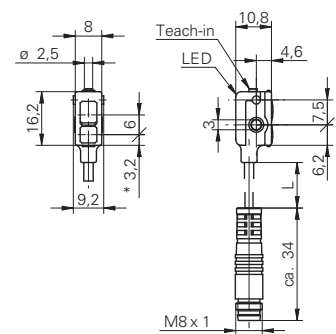

* emitter axis cable length L = 200 mm

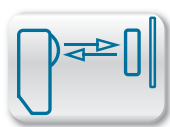

Tw = 55 ... 200 mm

IO-Link

- short response time
- sensing distance adjustable via Teach-in
- IO-Link



general data

| | |
|-----------------------------------|--------------------------|
| type | light barrier |
| light source | pulsed red LED |
| alignment / soiled lens indicator | flashing light indicator |
| power on indication | LED green |
| output indicator | LED red |
| sensing distance adjustment | Teach-in and IO-Link |
| wave length | 660 nm |

electrical data

| | |
|------------------------------------|----------------------|
| response time / release time | < 1,8 ms |
| voltage supply range +Vs | 10 ... 30 VDC |
| current consumption max. (no load) | 35 mA |
| current consumption typ. | 30 mA |
| voltage drop Vd | < 2 VDC |
| output function | light / dark operate |
| output circuit | push-pull |
| output current | < 100 mA |
| short circuit protection | yes |

mechanical data

| | |
|------------------|---------------------|
| width / diameter | 14,8 mm |
| height / length | 43 mm |
| depth | 31 mm |
| type | rectangular |
| housing material | plastic (ASA, MABS) |
| front (optics) | PMMA |

ambient conditions

| | |
|-----------------------|----------------|
| operating temperature | -30 ... +60 °C |
| protection class | IP 67 |

connection diagrams

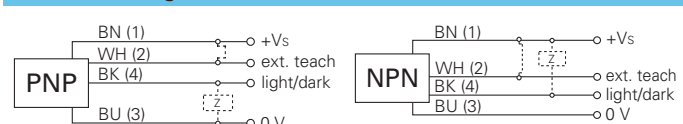

connectors

| | | |
|--------------|-------|--------------|
| ESG 32AH0200 | 4 pin | 2 m straight |
| ESW 31AH0200 | 4 pin | 2 m angular |

additional cable connectors and field wireable connectors, see accessories

accessories

| | |
|-----------------------|----------|
| SENSOFIX mounting kit | 10149011 |
| mounting bracket | 10134964 |

for details, see accessories section

| order reference | version | background position Sde | connection types | reverse polarity protection | scanning range sa | minimal signal attenuation |
|----------------------|---------------------------|-------------------------|---------------------|-----------------------------|-------------------|----------------------------|
| FNDK 14G6902/S14/IO | Tray and bottle detection | 200 ... 800 mm on V4A | connector M12 4 pin | yes, Vs to GND | - | 30 % |
| FNDK 14G6902/S35A/IO | Tray and bottle detection | 200 ... 800 mm on V4A | connector M8 4 pin | yes, Vs to GND | - | 30 % |
| FNDK 14G6903/S14/IO | Foil detection | 200 ... 800 mm on V4A | connector M12 4 pin | yes | - | 12 % |
| FNDK 14G6903/S35A/IO | Foil detection | 200 ... 800 mm on V4A | connector M8 4 pin | yes | - | 12 % |
| FNDK 14G6904/S14/IO | standard object detection | 50 ... 800 mm on V4A | connector M12 4 pin | yes | 96% Sde | - |
| FNDK 14G6904/S35A/IO | standard object detection | 50 ... 800 mm on V4A | connector M8 4 pin | yes | 96% Sde | - |

FNDK 14 Tw = 55 ... 200 mm

SmartReflect Light barriers

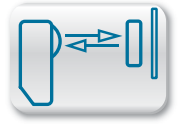

dimension drawings

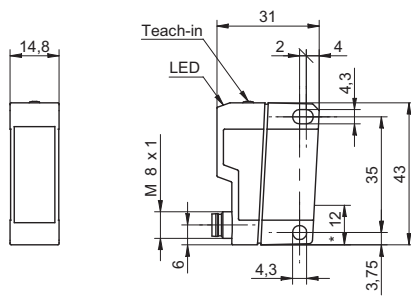

* emitter axis

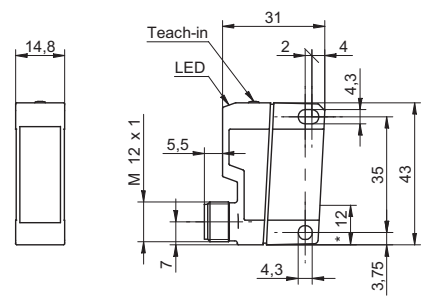

* emitter axis

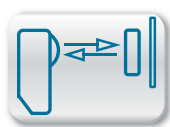

Tw = 50 ... 800 mm

IO-Link

- hygiene design
- IO-Link
- remote Teach-in



general data

| | |
|-----------------------------------|--------------------------|
| type | light barrier |
| special type | Hygiene design |
| light source | pulsed red LED |
| alignment / soiled lens indicator | flashing light indicator |
| power on indication | LED green |
| output indicator | LED red |
| wave length | 660 nm |
| Approvals/certificates | Ecolab EHEDG |

electrical data

| | |
|------------------------------------|----------------------|
| response time / release time | < 1,8 ms |
| voltage supply range +Vs | 10 ... 30 VDC |
| current consumption max. (no load) | 40 mA |
| current consumption typ. | 35 mA |
| voltage drop Vd | < 2 VDC |
| output function | light / dark operate |
| output circuit | push-pull |
| output current | < 100 mA |
| short circuit protection | yes |

mechanical data

| | |
|------------------|-----------------------------------|
| type | rectangular |
| housing material | stainless steel 1.4404 (V4A); LSR |
| front (optics) | PMMA |

ambient conditions

| | |
|-----------------------|----------------------|
| operating temperature | -30 ... +60 °C |
| protection class | IP 68/69K & proTect+ |
| storage temperature | -30 ... +70 °C |

connection diagrams

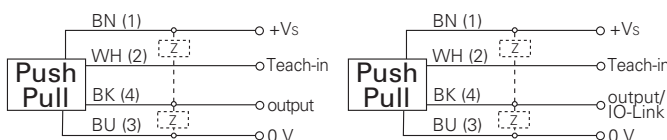

connectors

| | | |
|--------------|-------|--------------|
| ESG 34AF0200 | 4 pin | 2 m straight |
| ESW 33AF0200 | 4 pin | 2 m angular |

additional cable connectors and field wireable connectors, see accessories

accessories

| | | |
|---------------------------|---------|--------------|
| mounting | ø 17 mm | HI17-1H |
| stainless steel reflector | | FTDR 017W035 |

for details, see accessories section

remarks

Sensor FDA compliant, EHEDG certified and Ecolab approved
 IO-Link: output signal, service status, object presence
 sensitivity adjustable: via Teach-in wire input
 LSR = Liquid Silicon Rubber

| order reference | version | background position Sde | connection types | sensing distance adjustment | reverse polarity protection | scanning range | min. signal attenuation |
|-----------------------|---------------------------|-------------------------|---------------------------------|-----------------------------|-----------------------------|----------------|-------------------------|
| FNDH 14G6901 | standard object detection | 50 ... 800 mm on V4A | cable 4 pin, 2 m | Teach-in | yes | 96% Sde | - |
| FNDH 14G6901/IO | standard object detection | 50 ... 800 mm on V4A | cable 4 pin, 2 m | Teach-in and IO-Link | yes | 96% Sde | - |
| FNDH 14G6901/KS34A | standard object detection | 50 ... 800 mm on V4A | flylead connector M12, L=300 mm | Teach-in | yes | 96% Sde | - |
| FNDH 14G6901/KS34A/IO | standard object detection | 50 ... 800 mm on V4A | flylead connector M12, L=300 mm | Teach-in and IO-Link | yes | 96% Sde | - |
| FNDH 14G6902 | Tray and bottle detection | 200 ... 800 mm on V4A | cable 4 pin, 2 m | Teach-in | yes, Vs to GND | - | 30 % |
| FNDH 14G6902/IO | Tray and bottle detection | 200 ... 800 mm on V4A | cable 4 pin, 2 m | Teach-in and IO-Link | yes, Vs to GND | - | 30 % |
| FNDH 14G6902/KS34A | Tray and bottle detection | 200 ... 800 mm on V4A | flylead connector M12, L=300 mm | Teach-in | yes, Vs to GND | - | 30 % |
| FNDH 14G6902/KS34A/IO | Tray and bottle detection | 200 ... 800 mm on V4A | flylead connector M12, L=300 mm | Teach-in and IO-Link | yes, Vs to GND | - | 30 % |
| FNDH 14G6903 | Foil detection | 200 ... 800 mm on V4A | cable 4 pin, 2 m | Teach-in | yes | - | 12 % |
| FNDH 14G6903/IO | Foil detection | 200 ... 800 mm on V4A | cable 4 pin, 2 m | Teach-in and IO-Link | yes | - | 12 % |
| FNDH 14G6903/KS34A | Foil detection | 200 ... 800 mm on V4A | flylead connector M12, L=300 mm | Teach-in | yes | - | 12 % |
| FNDH 14G6903/KS34A/IO | Foil detection | 200 ... 800 mm on V4A | flylead connector M12, L=300 mm | Teach-in and IO-Link | yes | - | 12 % |

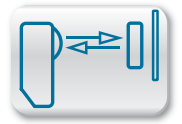

dimension drawings

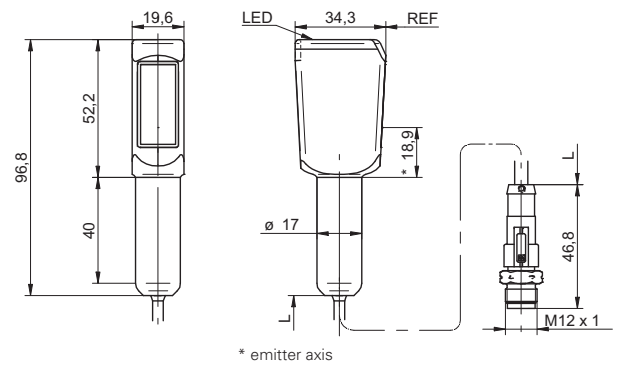
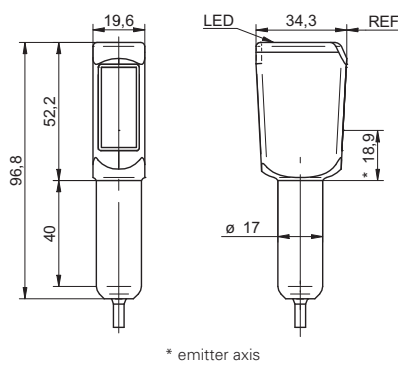

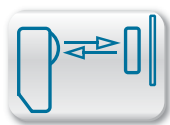

Tw = 50 ... 800 mm

IO-Link

- washdown design
- IO-Link
- remote Teach-in



general data

| | |
|-----------------------------------|--------------------------|
| type | light barrier |
| special type | Washdown design |
| light source | pulsed red LED |
| alignment / soiled lens indicator | flashing light indicator |
| power on indication | LED green |
| output indicator | LED red |
| wave length | 660 nm |
| Approvals/certificates | Ecolab |

electrical data

| | |
|------------------------------------|----------------------|
| response time / release time | < 1,8 ms |
| voltage supply range +Vs | 10 ... 30 VDC |
| current consumption max. (no load) | 40 mA |
| current consumption typ. | 35 mA |
| voltage drop Vd | < 2 VDC |
| output function | light / dark operate |
| output circuit | push-pull |
| output current | < 100 mA |
| short circuit protection | yes |

mechanical data

| | |
|------------------|-----------------------------------|
| width / diameter | 19,6 mm |
| height / length | 51 mm |
| depth | 34,3 mm |
| type | rectangular |
| housing material | stainless steel 1.4404 (V4A); LSR |
| front (optics) | PMMA |
| connection types | connector M12 |

ambient conditions

| | |
|-----------------------|----------------------|
| operating temperature | -30 ... +60 °C |
| protection class | IP 68/69K & proTect+ |
| storage temperature | -30 ... +70 °C |

connection diagrams

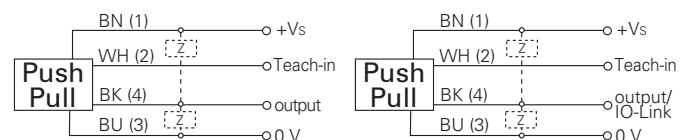

connectors

| | | |
|--------------|-------|--------------|
| ESG 32AH0200 | 4 pin | 2 m straight |
| ESW 31AH0200 | 4 pin | 2 m angular |

additional cable connectors and field wireable connectors, see accessories

accessories

| | |
|---------------------------|--------------|
| SENSOFIX mounting kit | 11046279 |
| mounting bracket | 11046278 |
| stainless steel reflector | FTDR 050R060 |
| stainless steel reflector | FTDR 017W035 |

for details, see accessories section

remarks

Sensor FDA compliant and Ecolab approved
 IO-Link: output signal, service status, object presence
 sensitivity adjustable: via Teach-in wire input
 LSR = Liquid Silicon Rubber

| order reference | version | background position Sde | sensing distance adjustment | reverse polarity protection | scanning range sa | minimal signal attenuation |
|----------------------------|---------------------------|-------------------------|-----------------------------|-----------------------------|-------------------|----------------------------|
| FNDR 14G6901/S14 | standard object detection | 50 ... 800 mm on V4A | Teach-in | yes | 96% Sde | - |
| FNDR 14G6901/S14/IO | standard object detection | 50 ... 800 mm on V4A | Teach-in and IO-Link | yes | 96% Sde | - |
| FNDR 14G6902/S14 | Tray and bottle detection | 200 ... 800 mm on V4A | Teach-in | yes, Vs to GND | - | 30 % |
| FNDR 14G6902/S14/IO | Tray and bottle detection | 200 ... 800 mm on V4A | Teach-in and IO-Link | yes, Vs to GND | - | 30 % |
| FNDR 14G6903/S14 | Foil detection | 200 ... 800 mm on V4A | Teach-in | yes | - | 12 % |
| FNDR 14G6903/S14/IO | Foil detection | 200 ... 800 mm on V4A | Teach-in and IO-Link | yes | - | 12 % |

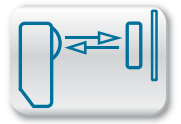

dimension drawing

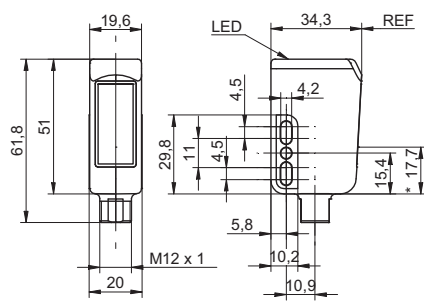

* emitter axis

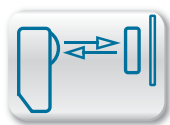

Tw = 100 ... 2000 mm

- long sensing range
- qTeach



general data

| | |
|-----------------------------------|---------------------------|
| type | light barrier |
| version | standard object detection |
| light source | pulsed red laser diode |
| background position Sde | 100 ... 2000 mm |
| scanning range sa | 90% ... 98% Sde |
| alignment / soiled lens indicator | flashing light indicator |
| power on indication | LED green |
| light indicator | LED yellow |
| sensing distance adjustment | Teach-in |
| laser class | 1 |
| wave length | 656 nm |
| beam diameter | 3,7 ... 22 mm |

electrical data

| | |
|------------------------------------|----------------------|
| response time / release time | < 10 ms |
| voltage supply range +Vs | 10 ... 30 VDC |
| current consumption max. (no load) | 80 mA |
| voltage drop Vd | < 3,5 VDC |
| output function | light / dark operate |
| output circuit | push-pull |
| output current | < 100 mA |
| short circuit protection | yes |
| reverse polarity protection | yes |

mechanical data

| | |
|------------------|--------------------------|
| width / diameter | 23,4 mm |
| height / length | 63 mm |
| depth | 45 mm |
| type | rectangular |
| housing material | plastic (SAN LURAN 378P) |
| front (optics) | PMMA |
| connection types | connector M12 4 pin |

ambient conditions

| | |
|-----------------------|----------------|
| operating temperature | 0 ... +50 °C |
| protection class | IP 67 |
| storage temperature | -10 ... +70 °C |

order reference

ONDK 25G6911/S14

connection diagram

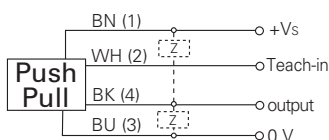

connectors

| | | |
|--------------|-------|--------------|
| ESG 34AH0200 | 4 pin | 2 m straight |
| ESW 33AH0200 | 4 pin | 2 m angular |

additional cable connectors and field wireable connectors, see accessories

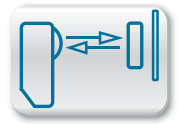

switching point



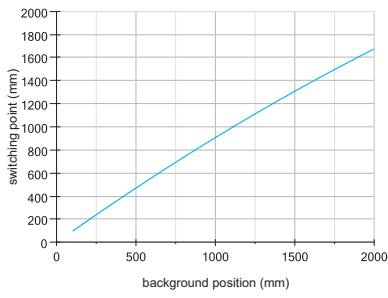

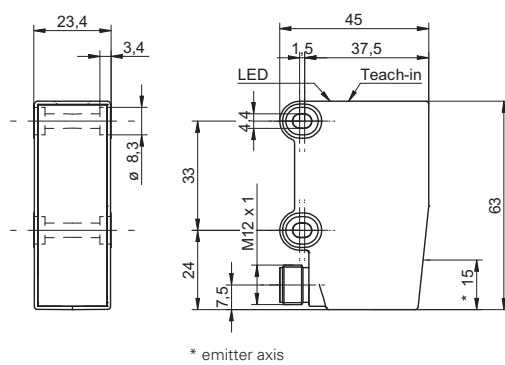

Sd = 100 ... 1000 mm







dimension drawing



red light LED version

| product family | FPCK 07 | FDPK 07 | FDPK 10 | FPDM 12 | FDPK 14 | FRDK 14 | FDPH 14 |
|------------------------------|---|---|---|---|---|---|---|
| |  |  |  |  |  |  |  |
| version | | | | | single lens optics | for transparent objects | |
| width / diameter | 8 mm | 8 mm | 10,4 mm | 12,4 mm | 14,8 mm | 14,8 mm | 19,6 mm |
| actual range Sb | 0,6 m | 0,6 m | 3,5 m | 5 m | 3,2 m 7 m | 7 m | 3 m |
| response time / release time | < 0,5 ms | < 0,5 ms | < 0,5 ms | < 1 ms | < 1 ms | < 0,1 ms | < 1 ms |
| sensitivity adjustment | Teach-in | Teach-in | no potentiometer, 240° | no | no | Teach-in | no |
| NPN | ■ | ■ | ■ | ■ | ■ | ■ | ■ |
| PNP | ■ | ■ | ■ | ■ | ■ | ■ | ■ |
| cable | ■ | ■ | ■ | ■ | ■ | ■ | ■ |
| flylead connector | ■ | ■ | | | | | ■ |
| connector | | | ■ | ■ | ■ | ■ | |
| housing material | plastic | plastic | plastic | metal | plastic | plastic | metal |
| page | 218 | 220 | 222 | 224 | 228 | 230 | 232 |

laser version

| product family | OPDM 12 | OPDK 14 | OPDK 14 | OPDM 16 |
|------------------------------|---|---|---|---|
| |  |  |  |  |
| version | single lens optics | single lens optics | for transparent objects single lens optics | |
| width / diameter | 12,4 mm | 14,8 mm | 14,8 mm | 15,4 mm |
| actual range Sb | 4,5 m 7 m | 10 m | 4,5 m | 7,5 m 11 m |
| response time / release time | < 0,05 ms < 0,1 ms | < 0,25 ms | < 0,25 ms | < 0,1 ms |
| sensitivity adjustment | no | Teach-in | Teach-in | no potentiometer, 270° |
| NPN | ■ | | | |
| PNP | ■ | ■ | ■ | ■ |
| cable | ■ | ■ | ■ | ■ |
| connector | ■ | ■ | ■ | ■ |
| housing material | metal | plastic | plastic | metal |
| page | 226 | 236 | 238 | 244 |

| FPDR 14 | FPDM 16 | FPDM 16 | FPAM 18 | FPDK 20 |
|---------|---------|---------|---------|---------|
|---------|---------|---------|---------|---------|



| | | | | |
|------------|---------------------------|-------------------------|------------|---------------------|
| | | for transparent objects | | |
| 19,6 mm | 15,4 mm | 15,4 mm | 18 mm | 20 mm |
| 3 m | 7,3 m | 6 m | 3,2 m | 5,5 m |
| < 1 ms | < 1 ms | < 2,5 ms | < 1 ms | < 0,5 ms |
| no | no potentiometer, 10 turn | Teach-in | no | potentiometer, 270° |
| ■ | ■ | | ■ | ■ |
| ■ | ■ | ■ | ■ | ■ |
| | ■ | | ■ | |
| ■ | ■ | ■ | ■ | ■ |
| metal | metal | metal | metal | plastic |
| 234 | 240 | 242 | 246 | 248 |



General information

The emitter and receiver are installed in the same housing. The emitted infrared, red or laser light is returned by a triple reflector or a reflective film to the receiver. The output changes its state when the object breaks the light beam (sensor receives no light).

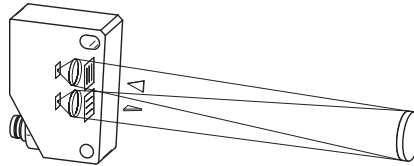

Applications

- Stack height monitoring
- Detection of objects located at any position on a conveyor belt
- Detection of transparent objects
- Detection of glossy objects on a conveyor belt
- Retro-reflective laser sensors with single-lens optics allow the precise detection of objects through small openings and the smallest distances between the sensor and the reflector.

Characteristics and advantages

Polarizing filter

This filter allows objects to be detected regardless of the texture and color of the surface. Glossy and reflective objects are also reliably detected.

Single-lens optics

Because the emitted and received beams are on the same axis, the direction of approach of the object is irrelevant, and it is possible to look through small openings. Reflectors can also be used in close-range without signal breakdown.

Transparent objects

Special versions of retro-reflective sensors can also reliably detect transparent objects such as packaging films, PET bottles and glassware.

Short response times

Retro-reflective laser sensors with response times of 0,05 ms and focused laser beams correctly detect the smallest, fast-moving objects (0,1 mm in diameter).

Technology and operation

The polarizing filter permits the emitted light to pass in only one polarization plane. The triple reflector depolarizes the light on reflection. A part of the light reflected back to the receiver passes the second polarization filter, offset by 90°, and is detected by the receiver.

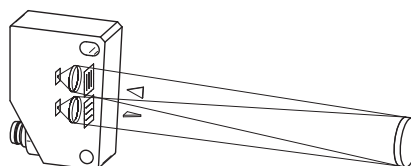



Technology and operation

A glossy object in the light beam reflects the light without changing its polarization direction. This light cannot pass through the polarization filter in front of the receiver. A glossy object therefore also breaks the light beam.

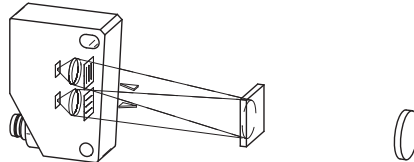

Mounting and adjustment

Each sensor has a separate excess gain curve. As the operating reliability depends heavily on the ambient conditions, it must be ensured that the sensor operates with the highest possible excess signal gain.

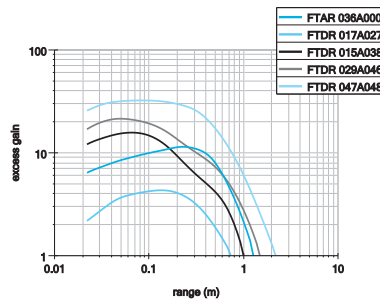

With narrow light beams as used in laser sensors, the size of the light spot on the reflector in relation to the triple structure is crucial factor when it comes to choosing the reflector or the reflective type. A special reflective type or reflector for laser sensors should be used for spot diameters of up to 1,5mm, while the use of reflectors with microstructures is recommended for spot diameters of up to 3 mm. It should also be ensured that the reflective type or reflector is not placed close to the focus.

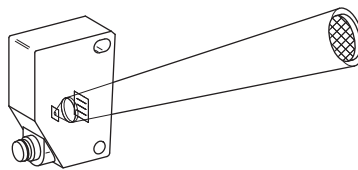

The reflector is aligned and centered.

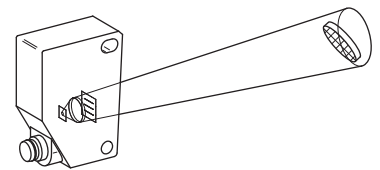

The reflector may not be tilted by more than 15°.

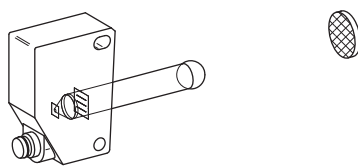

For a correct function, the object must cover the reflector or at least have the size of the beam diameter on the distance.

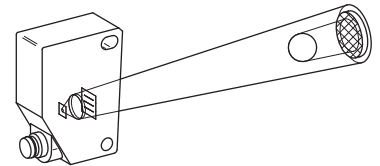

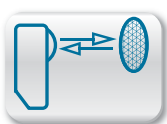

S_b = 0,6 m

- ultra compact housing
- sensing range adjustable via Teach-in
- suppression of mutual optical interference

general data

| | |
|-------------------------------------|--------------------------|
| type | retro-reflective sensor |
| light source | pulsed red LED |
| actual range S _b | 0,6 m |
| nominal range S _n | 0,8 m |
| polarization filter | yes |
| alignment / soiled lens indicator | flashing light indicator |
| light indicator | LED green |
| output indicator | LED yellow |
| sensitivity adjustment | Teach-in |
| wave length | 660 nm |
| suppression of reciprocal influence | yes |

electrical data

| | |
|------------------------------------|----------------------|
| response time / release time | < 0,5 ms |
| voltage supply range +Vs | 10 ... 30 VDC |
| current consumption max. (no load) | 25 mA |
| current consumption typ. | 20 mA |
| voltage drop V _d | < 1,8 VDC |
| output function | light / dark operate |
| output current | < 100 mA |
| short circuit protection | yes |
| reverse polarity protection | yes |

mechanical data

| | |
|------------------|--------------------------|
| width / diameter | 8 mm |
| height / length | 17,8 mm |
| depth | 12,6 mm |
| type | rectangular |
| housing material | plastic (PMMA, MABS, PA) |
| front (optics) | PMMA |

ambient conditions

| | |
|-----------------------|----------------|
| operating temperature | -20 ... +50 °C |
| protection class | IP 65 |

| order reference | connection types | output circuit |
|--------------------|----------------------------|----------------|
| FPCK 07N6901 | cable rear side, 2 m | NPN |
| FPCK 07N6901/KS35A | flylead connector M8 4 pin | NPN |
| FPCK 07P6901 | cable rear side, 2 m | PNP |
| FPCK 07P6901/KS35A | flylead connector M8 4 pin | PNP |



connection diagrams



connectors

| | | |
|--------------|-------|--------------|
| ESG 32AH0200 | 4 pin | 2 m straight |
| ESW 31AH0200 | 4 pin | 2 m angular |

additional cable connectors and field wireable connectors, see accessories

accessories

| | |
|----------------------|----------|
| MINOFIX mounting kit | 10150844 |
|----------------------|----------|

for details, see accessories section

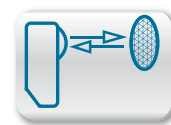

excess gain curves

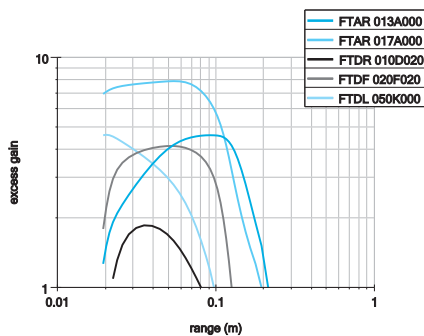
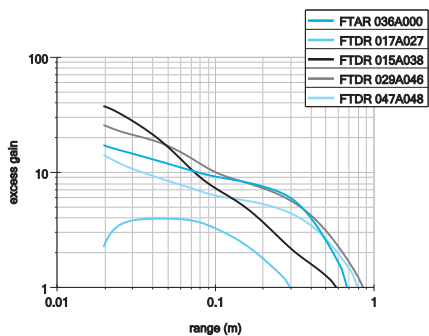

reflectors

| | | |
|--------------------|----------------|-------------|
| FTAR 013A000 | ∅ 15 mm | Sn = 210 mm |
| FTAR 017A000 | ∅ 20,7 mm | Sn = 190 mm |
| FTAR 036A000 | ∅ 46 mm | Sn = 680 mm |
| FTDR 010D020 | 15 x 25 mm | Sn = 80 mm |
| FTDR 017A027 | 20 x 42 mm | Sn = 290 mm |
| FTDR 015A038 | 18 x 40 mm | Sn = 570 mm |
| FTDR 029A046 | 32,5 x 48 mm | Sn = 830 mm |
| FTDR 047A048 | 54 x 75 mm | Sn = 790 mm |
| FTDF 020F020 | 20 x 20 mm | Sn = 120 mm |
| FTDL 050K000/... m | tape 50x... mm | Sn = 97 mm |

dimension drawings

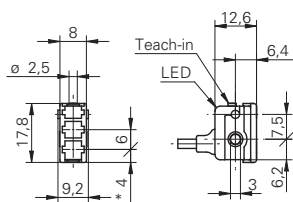

* emitter axis

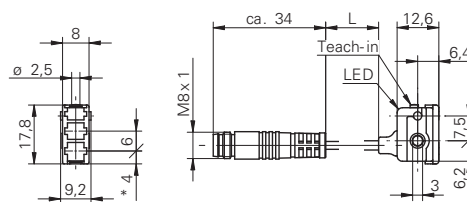

* emitter axis cable length L = 200 mm

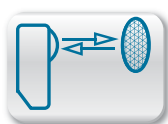

S_b = 0,6 m

- ultra compact housing
- sensing range adjustable via Teach-in
- suppression of mutual optical interference

general data

| | |
|-------------------------------------|--------------------------|
| type | retro-reflective sensor |
| light source | pulsed red LED |
| actual range S _b | 0,6 m |
| nominal range S _n | 0,8 m |
| polarization filter | yes |
| alignment / soiled lens indicator | flashing light indicator |
| light indicator | LED green |
| output indicator | LED yellow |
| sensitivity adjustment | Teach-in |
| wave length | 660 nm |
| suppression of reciprocal influence | yes |

electrical data

| | |
|------------------------------------|----------------------|
| response time / release time | < 0,5 ms |
| voltage supply range +Vs | 10 ... 30 VDC |
| current consumption max. (no load) | 25 mA |
| current consumption typ. | 20 mA |
| voltage drop V _d | < 1,8 VDC |
| output function | light / dark operate |
| output current | < 100 mA |
| short circuit protection | yes |
| reverse polarity protection | yes |

mechanical data

| | |
|------------------|--------------------------|
| width / diameter | 8 mm |
| height / length | 17,8 mm |
| depth | 12,6 mm |
| type | rectangular |
| housing material | plastic (PMMA, MABS, PA) |
| front (optics) | PMMA |

ambient conditions

| | |
|-----------------------|----------------|
| operating temperature | -20 ... +50 °C |
| protection class | IP 65 |

| order reference | connection types | output circuit |
|--------------------|----------------------------|----------------|
| FPDK 07N6901 | cable bottom side, 2 m | NPN |
| FPDK 07N6901/KS35A | flylead connector M8 4 pin | NPN |
| FPDK 07P6901 | cable bottom side, 2 m | PNP |
| FPDK 07P6901/KS35A | flylead connector M8 4 pin | PNP |



connection diagrams



connectors

| | | |
|--------------|-------|--------------|
| ESG 32AH0200 | 4 pin | 2 m straight |
| ESW 31AH0200 | 4 pin | 2 m angular |

additional cable connectors and field wireable connectors, see accessories

accessories

| | |
|----------------------|----------|
| MINOFIX mounting kit | 10150844 |
|----------------------|----------|

for details, see accessories section

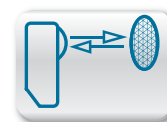

excess gain curves

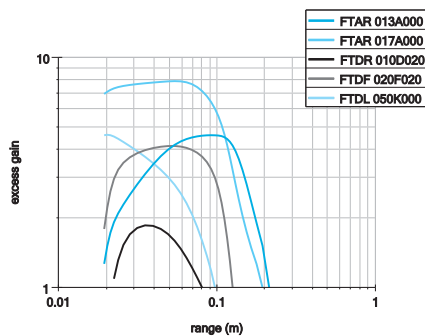
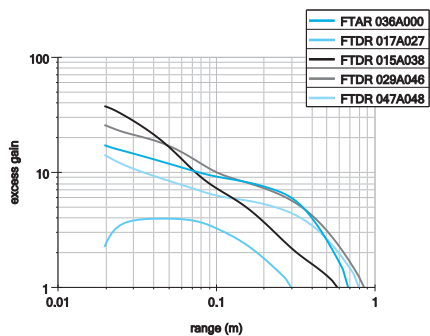

reflectors

| | | |
|--------------------|---------------|-------------|
| FTAR 013A000 | ∅ 15 mm | Sn = 210 mm |
| FTAR 017A000 | ∅ 20,7 mm | Sn = 190 mm |
| FTAR 036A000 | ∅ 46 mm | Sn = 680 mm |
| FTDR 010D020 | 15 x 25 mm | Sn = 80 mm |
| FTDR 017A027 | 20 x 42 mm | Sn = 290 mm |
| FTDR 015A038 | 18 x 40 mm | Sn = 570 mm |
| FTDR 029A046 | 32,5 x 48 mm | Sn = 830 mm |
| FTDR 047A048 | 54 x 75 mm | Sn = 790 mm |
| FTDF 020F020 | 20 x 20 mm | Sn = 120 mm |
| FTDL 050K000/... m | tape 50x...mm | Sn = 97 mm |

dimension drawings

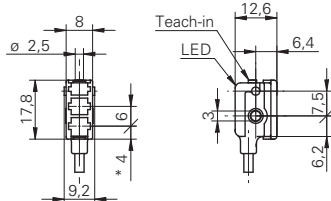

* emitter axis

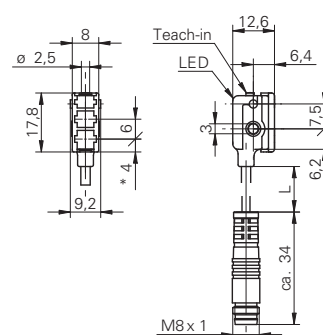

* emitter axis cable length L = 200 mm

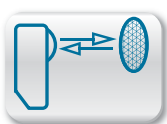

S_b = 3,5 m

- compact housing
- polarization filter to detect shiny objects
- suppression of mutual optical interference

general data

| | |
|-------------------------------------|--------------------------|
| type | retro-reflective sensor |
| light source | pulsed red LED |
| actual range S _b | 3,5 m |
| nominal range S _n | 4 m |
| polarization filter | yes |
| alignment / soiled lens indicator | flashing light indicator |
| light indicator | LED yellow |
| wave length | 660 nm |
| suppression of reciprocal influence | yes |

electrical data

| | |
|------------------------------------|----------------------|
| response time / release time | < 0,5 ms |
| voltage supply range +Vs | 10 ... 30 VDC |
| current consumption max. (no load) | 25 mA |
| current consumption typ. | 20 mA |
| voltage drop V _d | < 1,8 VDC |
| output function | light / dark operate |
| output current | < 100 mA |
| short circuit protection | yes |
| reverse polarity protection | yes |

mechanical data

| | |
|------------------|---------------|
| width / diameter | 10,4 mm |
| height / length | 27 mm |
| depth | 16,3 mm |
| type | rectangular |
| housing material | plastic (ASA) |
| front (optics) | PMMA |

ambient conditions

| | |
|-----------------------|----------------|
| operating temperature | -25 ... +65 °C |
|-----------------------|----------------|



connection diagrams



connectors

| | | |
|--------------|-------|--------------|
| ESG 32AH0200 | 4 pin | 2 m straight |
| ESW 31AH0200 | 4 pin | 2 m angular |

additional cable connectors and field wireable connectors, see accessories

accessories

| | |
|-----------------------------------|----------|
| <i>SENSOFIX</i> mounting kit | 10150326 |
| mounting bracket (cable type) | 10114501 |
| mounting bracket (connector type) | 10133792 |

for details, see accessories section

| order reference | connection types | output circuit | sensitivity adjustment | protection class |
|-------------------|--------------------|----------------|------------------------|------------------|
| FPDK 10N5130 | cable 4 pin, 2 m | NPN | no | IP 65 |
| FPDK 10N5130/S35A | connector M8 4 pin | NPN | no | IP 67 |
| FPDK 10N5135 | cable 4 pin, 2 m | NPN | potentiometer, 240° | IP 65 |
| FPDK 10N5135/S35A | connector M8 4 pin | NPN | potentiometer, 240° | IP 67 |
| FPDK 10P5130 | cable 4 pin, 2 m | PNP | no | IP 65 |
| FPDK 10P5130/S35A | connector M8 4 pin | PNP | no | IP 67 |
| FPDK 10P5135 | cable 4 pin, 2 m | PNP | potentiometer, 240° | IP 65 |
| FPDK 10P5135/S35A | connector M8 4 pin | PNP | potentiometer, 240° | IP 67 |

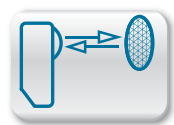

excess gain curves

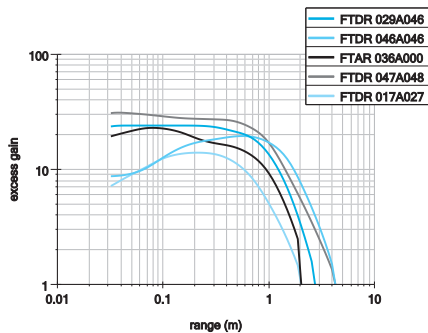
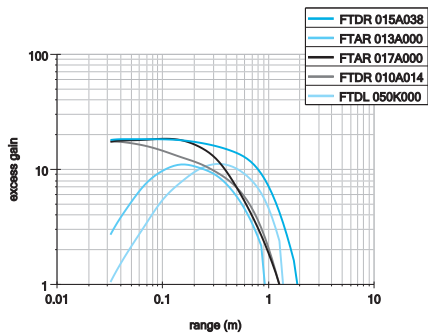

reflectors

| | | |
|--------------------|------------------|------------|
| FTAR 013A000 | ∅ 15 mm | Sn = 0,9 m |
| FTAR 017A000 | ∅ 20,7 mm | Sn = 1,2 m |
| FTAR 036A000 | ∅ 46 mm | Sn = 2 m |
| FTDR 010D014 | 12,8 x 16,8 mm | Sn = 1,2 m |
| FTDR 017A027 | 20 x 42 mm | Sn = 2 m |
| FTDR 015A038 | 18 x 40 mm | Sn = 1,8 m |
| FTDR 029A046 | 32,5 x 48 mm | Sn = 2,7 m |
| FTDR 047A048 | 54 x 75 mm | Sn = 4 m |
| FTDL 050K000/... m | tape 50 x ... mm | Sn = 1,3 m |

dimension drawings

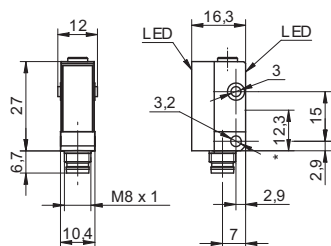

* emitter axis

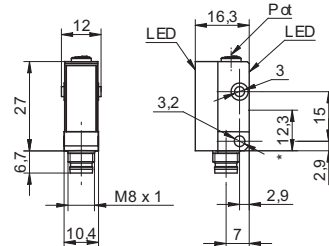

* emitter axis

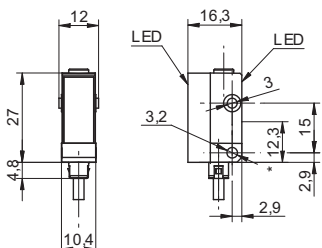

* emitter axis

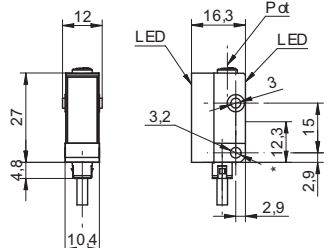

* emitter axis

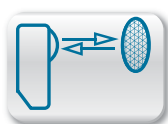

Sb = 5 m

- rugged miniature metal housing
- polarization filter to detect shiny objects
- available with alarm output

general data

| | |
|-------------------------------------|--------------------------|
| type | retro-reflective sensor |
| light source | pulsed red LED |
| actual range Sb | 5 m |
| nominal range Sn | 5,2 m |
| polarization filter | yes |
| alignment / soiled lens indicator | flashing light indicator |
| light indicator | LED yellow |
| sensitivity adjustment | no |
| wave length | 660 nm |
| suppression of reciprocal influence | yes |

electrical data

| | |
|------------------------------------|---------------|
| response time / release time | < 1 ms |
| voltage supply range +Vs | 10 ... 30 VDC |
| current consumption max. (no load) | 35 mA |
| current consumption typ. | 25 mA |
| voltage drop Vd | < 1,8 VDC |
| output current | < 100 mA |
| short circuit protection | yes |
| reverse polarity protection | yes |

mechanical data

| | |
|------------------|---------------|
| width / diameter | 12,4 mm |
| height / length | 35 mm |
| depth | 35 mm |
| type | rectangular |
| housing material | die-cast zinc |
| front (optics) | PMMA |

ambient conditions

| | |
|-----------------------|----------------|
| operating temperature | -25 ... +65 °C |
| protection class | IP 67 |



connection diagrams

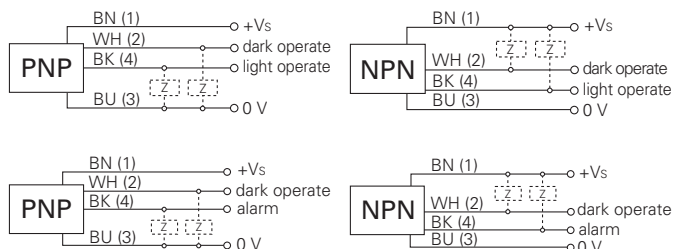

connectors

| | | |
|--------------|-------|--------------|
| ESG 32AH0200 | 4 pin | 2 m straight |
| ESW 31AH0200 | 4 pin | 2 m angular |

additional cable connectors and field wireable connectors, see accessories

accessories

| | |
|-----------------------|----------|
| SENSOFIX mounting kit | 10150328 |
| mounting bracket | 10113873 |

for details, see accessories section

| order reference | connection types | output circuit | output function |
|-------------------|--------------------|----------------|----------------------|
| FPDM 12N3401 | cable 4 pin, 2 m | NPN | alarm output dark |
| FPDM 12N3401/S35A | connector M8 4 pin | NPN | alarm output dark |
| FPDM 12N5101 | cable 4 pin, 2 m | NPN | light / dark operate |
| FPDM 12N5101/S35A | connector M8 4 pin | NPN | light / dark operate |
| FPDM 12P3401 | cable 4 pin, 2 m | PNP | alarm output dark |
| FPDM 12P3401/S35A | connector M8 4 pin | PNP | alarm output dark |
| FPDM 12P5101 | cable 4 pin, 2 m | PNP | light / dark operate |
| FPDM 12P5101/S35A | connector M8 4 pin | PNP | light / dark operate |

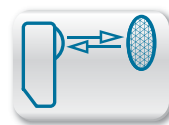

excess gain curves

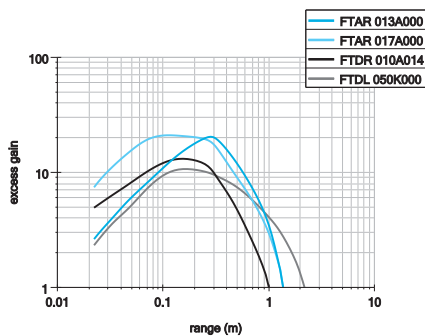
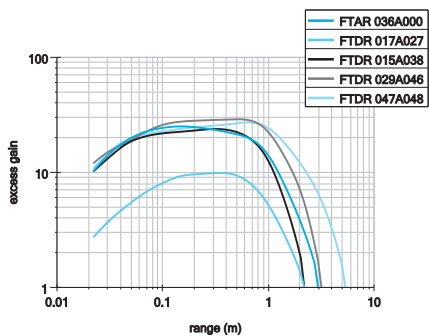

reflectors

| | | |
|--------------------|------------------|------------|
| FTAR 013A000 | ∅ 15 mm | Sn = 1,2 m |
| FTAR 017A000 | ∅ 20,7 mm | Sn = 1,2 m |
| FTAR 036A000 | ∅ 46 mm | Sn = 2,9 m |
| FTDR 010D014 | 12,8 x 16,8 mm | Sn = 1 m |
| FTDR 017A027 | 20 x 42 mm | Sn = 2,1 m |
| FTDR 015A038 | 18 x 40 mm | Sn = 2,1 m |
| FTDR 029A046 | 32,5 x 48 mm | Sn = 3,1 m |
| FTDR 047A048 | 54 x 75 mm | Sn = 5,2 m |
| FTDL 050K000/... m | tape 50 x ... mm | Sn = 2,1 m |

dimension drawings

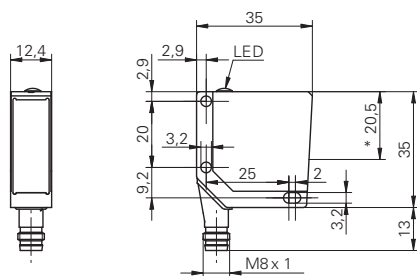

* emitter axis

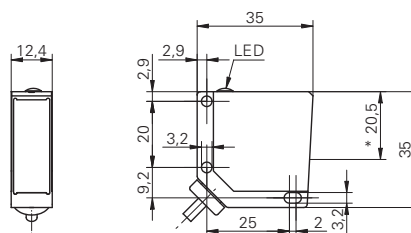

* emitter axis

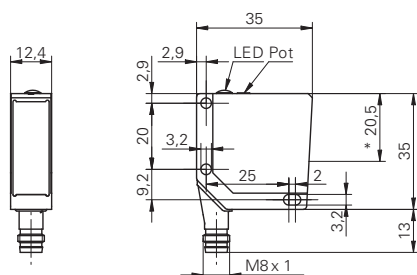

* emitter axis

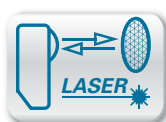

S_b = 7 m

- rugged miniature metal housing
- single lens optics
- short response time



general data

| | |
|-----------------------------------|-------------------------------|
| type | retro-reflective laser sensor |
| version | single lens optics |
| light source | pulsed red laser diode |
| repeat accuracy | < 0,1 mm at laser focus |
| polarization filter | yes |
| alignment / soiled lens indicator | flashing light indicator |
| light indicator | LED yellow |
| power on indication | LED green |
| sensitivity adjustment | no |
| laser class | 2 |
| wave length | 650 nm |

actual range S_b = 4,5 m

| | |
|------------------------------|-----|
| nominal range S _n | 5 m |
|------------------------------|-----|

actual range S_b = 7 m

| | |
|------------------------------|-----|
| nominal range S _n | 8 m |
|------------------------------|-----|

electrical data

| | |
|------------------------------------|----------------------|
| voltage supply range +Vs | 10 ... 30 VDC |
| current consumption max. (no load) | 50 mA |
| current consumption typ. | 40 mA |
| voltage drop V _d | < 1,8 VDC |
| output function | light / dark operate |
| output current | < 100 mA |
| short circuit protection | yes |
| reverse polarity protection | yes |

mechanical data

| | |
|------------------|---------------|
| width / diameter | 12,4 mm |
| height / length | 35 mm |
| depth | 35 mm |
| type | rectangular |
| housing material | die-cast zinc |
| front (optics) | glass |

ambient conditions

| | |
|-----------------------|----------------|
| operating temperature | -10 ... +50 °C |
| protection class | IP 67 |

connection diagrams



connectors

| | | |
|--------------|-------|--------------|
| ESG 32AH0200 | 4 pin | 2 m straight |
| ESW 31AH0200 | 4 pin | 2 m angular |

additional cable connectors and field wireable connectors, see accessories

accessories

| | |
|-----------------------|----------|
| SENSOFIX mounting kit | 10150328 |
| mounting bracket | 10113873 |

for details, see accessories section

laser warning

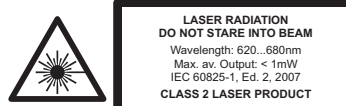

Complies with 21 CFR 1040.10 and 1040.11 except for deviations pursuant to laser notice No. 50, dated June 24, 2007

| order reference | actual range S _b | connection types | output circuit | response time / release time | distance to focus |
|-------------------|-----------------------------|--------------------|----------------|------------------------------|-------------------|
| OPDM 12N5101/S35A | 7 m | connector M8 4 pin | NPN | < 0,1 ms | 400 mm |
| OPDM 12P5101 | 7 m | cable 4 pin, 2 m | PNP | < 0,1 ms | 400 mm |
| OPDM 12P5101/S35A | 7 m | connector M8 4 pin | PNP | < 0,1 ms | 400 mm |
| OPDM 12P5102/S35A | 4,5 m | connector M8 4 pin | PNP | < 0,1 ms | 100 mm |
| OPDM 12P5103/S35A | 7 m | connector M8 4 pin | PNP | < 0,1 ms | parallel beam |
| OPDM 12P5104/S35A | 4,5 m | connector M8 4 pin | PNP | < 0,05 ms | 100 mm |

OPDM 12

Retro-reflective sensors

excess gain curves

Sb = 7 m

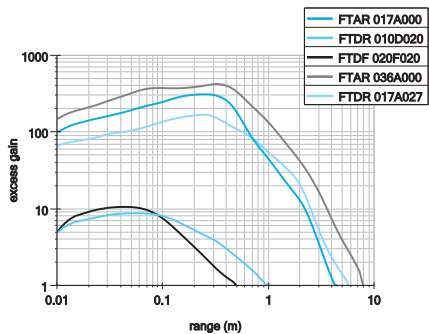

Sb = 4,5 m

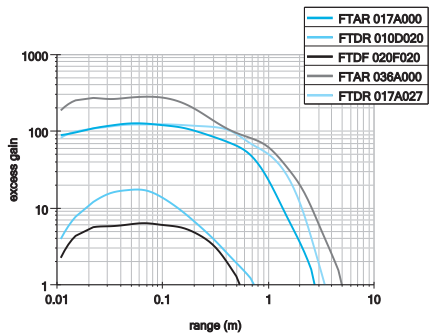

reflectors

| | | |
|--------------|------------|-------------|
| FTAR 017A000 | ∅ 20,7 mm | Sn = 4,1 m |
| FTAR 036A000 | ∅ 46 mm | Sn = 8 m |
| FTDR 010D020 | 15 x 25 mm | Sn = 0,95 m |
| FTDR 017A027 | 20 x 42 mm | Sn = 5,7 m |
| FTDF 020F020 | 20 x 20 mm | Sn = 0,5 m |

| | | |
|--------------|------------|-------------|
| FTAR 017A000 | ∅ 20,7 mm | Sn = 2,7 m |
| FTAR 036A000 | ∅ 46 mm | Sn = 5 m |
| FTDR 010D020 | 15 x 25 mm | Sn = 0,71 m |
| FTDR 017A027 | 20 x 42 mm | Sn = 3,2 m |
| FTDF 020F020 | 20 x 20 mm | Sn = 0,5 m |

beam characteristics (typically)

Sb = 7 m

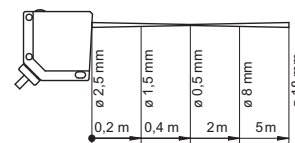

Sb = 4,5 m

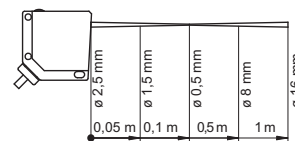

dimension drawings

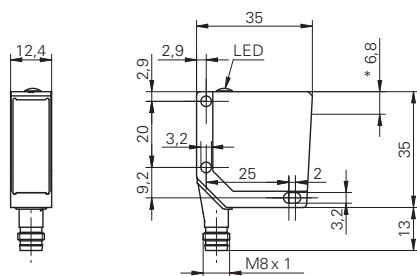

* emitter and receiver axis

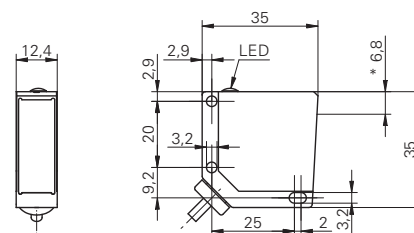

* emitter and receiver axis

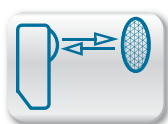

Sb = 7 m

- polarization filter to detect shiny objects
- single lens optics (FPDK 14x5111/S35A)
- suppression of mutual optical interference



general data

| | |
|-------------------------------------|--------------------------|
| type | retro-reflective sensor |
| light source | pulsed red LED |
| polarization filter | yes |
| alignment / soiled lens indicator | flashing light indicator |
| light indicator | LED yellow |
| sensitivity adjustment | no |
| wave length | 660 nm |
| suppression of reciprocal influence | yes |

actual range Sb = 3,2 m

| | |
|------------------|--------------------|
| version | single lens optics |
| nominal range Sn | 3,8 m |

actual range Sb = 7 m

| | |
|------------------|-------|
| nominal range Sn | 7,2 m |
|------------------|-------|

electrical data

| | |
|------------------------------------|----------------------|
| response time / release time | < 1 ms |
| voltage supply range +Vs | 10 ... 30 VDC |
| current consumption max. (no load) | 25 mA |
| current consumption typ. | 20 mA |
| voltage drop Vd | < 1,8 VDC |
| output function | light / dark operate |
| output current | < 100 mA |
| short circuit protection | yes |
| reverse polarity protection | yes |

mechanical data

| | |
|------------------|---------------------|
| width / diameter | 14,8 mm |
| height / length | 43 mm |
| depth | 31 mm |
| type | rectangular |
| housing material | plastic (ASA, MABS) |
| front (optics) | PMMA |

ambient conditions

| | |
|-----------------------|----------------|
| operating temperature | -25 ... +65 °C |
| protection class | IP 67 |

connection diagrams



connectors

| | | |
|--------------|-------|--------------|
| ESG 32AH0200 | 4 pin | 2 m straight |
| ESW 31AH0200 | 4 pin | 2 m angular |

additional cable connectors and field wireable connectors, see accessories

accessories

| | |
|-----------------------|----------|
| SENSOFIX mounting kit | 10149011 |
| mounting bracket | 10134964 |

for details, see accessories section

| order reference | actual range Sb | connection types | output circuit |
|-------------------|-----------------|---------------------|----------------|
| FPDK 14N5101 | 7 m | cable 4 pin, 2 m | NPN |
| FPDK 14N5101/S14 | 7 m | connector M12 4 pin | NPN |
| FPDK 14N5101/S35A | 7 m | connector M8 4 pin | NPN |
| FPDK 14N5111 | 3,2 m | cable 4 pin, 2 m | NPN |
| FPDK 14N5111/S14 | 3,2 m | connector M12 4 pin | NPN |
| FPDK 14N5111/S35A | 3,2 m | connector M8 4 pin | NPN |
| FPDK 14P5101 | 7 m | cable 4 pin, 2 m | PNP |
| FPDK 14P5101/S14 | 7 m | connector M12 4 pin | PNP |
| FPDK 14P5101/S35A | 7 m | connector M8 4 pin | PNP |
| FPDK 14P5111 | 3,2 m | cable 4 pin, 2 m | PNP |
| FPDK 14P5111/S14 | 3,2 m | connector M12 4 pin | PNP |
| FPDK 14P5111/S35A | 3,2 m | connector M8 4 pin | PNP |

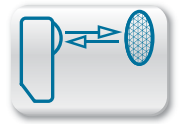

excess gain curves

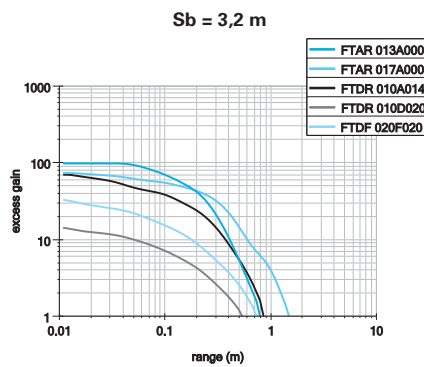
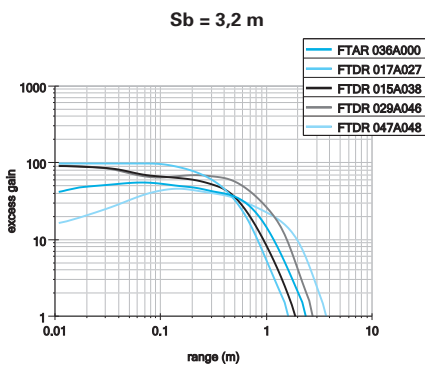
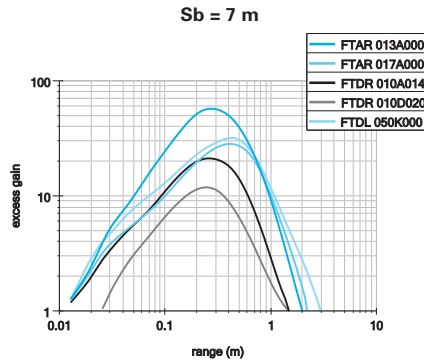
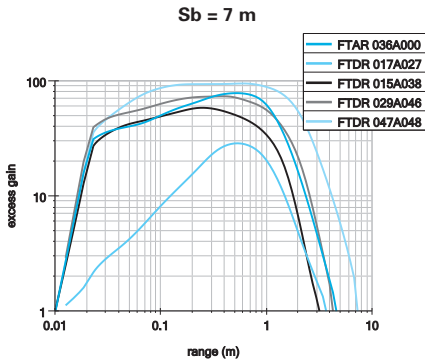

reflectors

| | | |
|------------------|------------------|------------|
| FTAR 013A000 | ∅ 15 mm | Sn = 2 m |
| FTAR 017A000 | ∅ 20,7 mm | Sn = 2,1 m |
| FTAR 036A000 | ∅ 46 mm | Sn = 4,5 m |
| FTDR 010D14 | 12,8 x 16,8 mm | Sn = 1,4 m |
| FTDR 010D020 | 15 x 25 mm | Sn = 1,4 m |
| FTDR 017A027 | 20 x 42 mm | Sn = 3,6 m |
| FTDR 015A038 | 18 x 40 mm | Sn = 3,1 m |
| FTDR 029A046 | 32,5 x 48 mm | Sn = 4,2 m |
| FTDR 047A048 | 54 x 75 mm | Sn = 7,2 m |
| FTDL 050K000/... | tape 50 x ... mm | Sn = 2,9 m |

| | | |
|--------------|----------------|------------|
| FTAR 013A000 | ∅ 15 mm | Sn = 0,8 m |
| FTAR 017A000 | ∅ 20,7 mm | Sn = 1,4 m |
| FTAR 036A000 | ∅ 46 mm | Sn = 2,2 m |
| FTDR 010D14 | 12,8 x 16,8 mm | Sn = 0,8 m |
| FTDR 010D020 | 15 x 25 mm | Sn = 0,5 m |
| FTDR 017A027 | 20 x 42 mm | Sn = 1,5 m |
| FTDR 015A038 | 18 x 40 mm | Sn = 1,8 m |
| FTDR 029A046 | 32,5 x 48 mm | Sn = 2,8 m |
| FTDR 047A048 | 54 x 75 mm | Sn = 3,8 m |
| FTDF 020F020 | 20 x 20 mm | Sn = 0,7 m |

dimension drawings

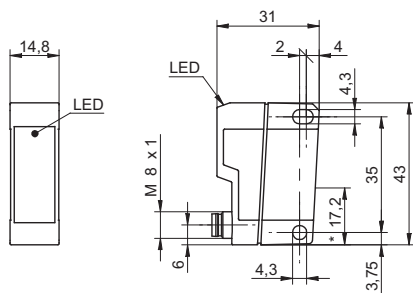

* emitter axis FPKD 14x5101/S35A

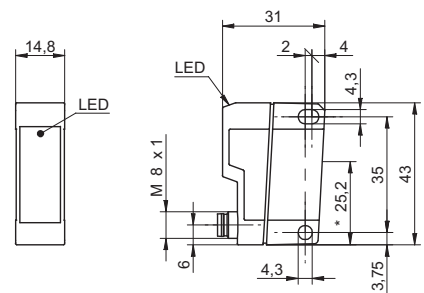

* emitter and receiver axis FPKD 14x5111... single lens optics

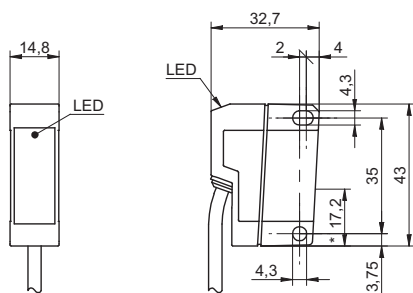

* emitter axis FPKD 14x5101

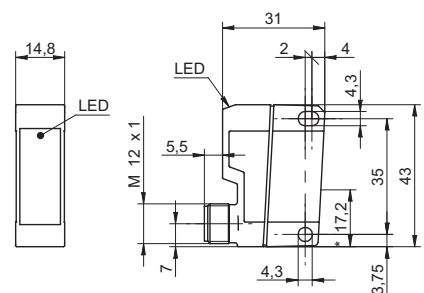

* emitter axis FPKD 14x5101/S14

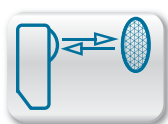

Sb = 7 m

- designed for detection of transparent objects
- sensitivity adjustable via Teach-in
- short response time

general data

| | |
|------------------------|-------------------------|
| type | retro-reflective sensor |
| version | for transparent objects |
| light source | pulsed red LED |
| actual range Sb | 7 m |
| nominal range Sn | 8 m |
| polarization filter | no |
| light indicator | LED yellow |
| sensitivity adjustment | Teach-in |
| wave length | 660 nm |

electrical data

| | |
|------------------------------------|---------------------------------|
| response time / release time | < 0,1 ms |
| teach-in signal time | > 500 µs |
| adaption time | < 20 ms |
| voltage supply range +Vs | 10 ... 30 VDC |
| current consumption max. (no load) | 40 mA |
| current consumption typ. | 35 mA |
| voltage drop Vd | < 2,2 VDC |
| output function | light / dark operate switchable |
| output current | < 100 mA |
| short circuit protection | yes |
| reverse polarity protection | yes |

mechanical data

| | |
|------------------|---------------------|
| width / diameter | 14,8 mm |
| height / length | 43 mm |
| depth | 31 mm |
| type | rectangular |
| housing material | plastic (ASA, MABS) |
| front (optics) | PMMA |

ambient conditions

| | |
|-----------------------|----------------|
| operating temperature | -25 ... +65 °C |
| protection class | IP 67 |

order reference

| order reference | connection types | output circuit |
|-------------------|---------------------|----------------|
| FRDK 14N6901 | cable 4 pin, 2 m | NPN |
| FRDK 14N6901/S14 | connector M12 4 pin | NPN |
| FRDK 14N6901/S35A | connector M8 4 pin | NPN |
| FRDK 14P6901 | cable 4 pin, 2 m | PNP |
| FRDK 14P6901/S14 | connector M12 4 pin | PNP |
| FRDK 14P6901/S35A | connector M8 4 pin | PNP |

**connection diagrams****connectors**

| | | |
|--------------|-------|--------------|
| ESG 32AH0200 | 4 pin | 2 m straight |
| ESW 31AH0200 | 4 pin | 2 m angular |

additional cable connectors and field wireable connectors, see accessories

accessories

| | |
|-----------------------|----------|
| SENSOFIX mounting kit | 10149011 |
| mounting bracket | 10134964 |

for details, see accessories section

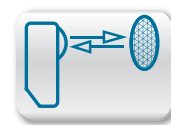

excess gain curves

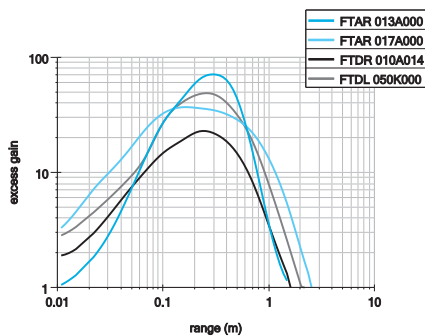
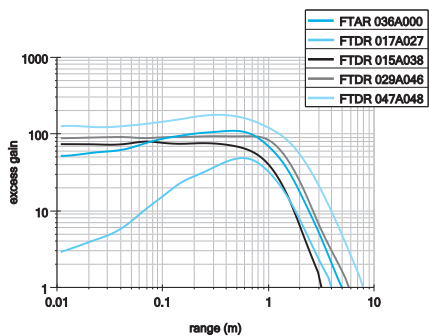

reflectors

| | | |
|--------------------|------------------|------------|
| FTAR 013A000 | ∅ 15 mm | Sn = 1,7 m |
| FTAR 017A000 | ∅ 20,7 mm | Sn = 2,4 m |
| FTAR 036A000 | ∅ 46 mm | Sn = 5 m |
| FTDR 010A014 | 12,8 x 16,8 mm | Sn = 1,7 m |
| FTDR 017A027 | 20 x 42 mm | Sn = 4 m |
| FTDR 015A038 | 18 x 40 mm | Sn = 2,1 m |
| FTDR 029A046 | 32,5 x 48 mm | Sn = 5,8 m |
| FTDR 047A048 | 54 x 75 mm | Sn = 8 m |
| FTDL 050K000/... m | tape 50 x ... mm | Sn = 2 m |

dimension drawings

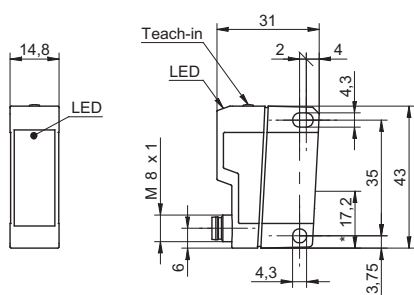

* emitter axis

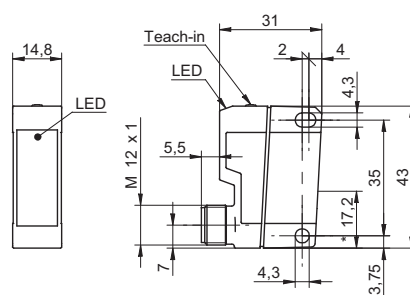

* emitter axis

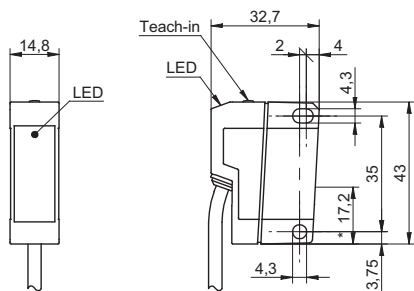

* emitter axis

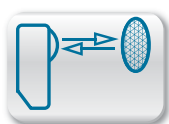

Sb = 3 m

- hygiene design
- EHEDG certified

general data

| | |
|-------------------------------------|--------------------------|
| type | retro-reflective sensor |
| special type | Hygiene design |
| light source | pulsed red LED |
| actual range Sb | 3 m |
| nominal range Sn | 3,5 m |
| polarization filter | yes |
| alignment / soiled lens indicator | flashing light indicator |
| light indicator | LED yellow |
| sensitivity adjustment | no |
| wave length | 660 nm |
| suppression of reciprocal influence | yes |
| Approvals/certificates | Ecolab EHEDG |

electrical data

| | |
|------------------------------------|----------------------|
| response time / release time | < 1 ms |
| voltage supply range +Vs | 10 ... 30 VDC |
| current consumption max. (no load) | 25 mA |
| current consumption typ. | 20 mA |
| voltage drop Vd | < 1,8 VDC |
| output function | light / dark operate |
| output current | < 100 mA |
| short circuit protection | yes |
| reverse polarity protection | yes |

mechanical data

| | |
|------------------|-----------------------------------|
| width / diameter | 19,6 mm |
| height / length | 52,2 mm |
| depth | 34,3 mm |
| type | rectangular |
| housing material | stainless steel 1.4404 (V4A); LSR |
| front (optics) | PMMA |

ambient conditions

| | |
|-----------------------|----------------------|
| operating temperature | -30 ... +60 °C |
| protection class | IP 68/69K & proTect+ |
| storage temperature | -30 ... +70 °C |



connection diagrams



connectors

| | | |
|--------------|-------|--------------|
| ESG 34AF0200 | 4 pin | 2 m straight |
| ESW 33AF0200 | 4 pin | 2 m angular |

additional cable connectors and field wireable connectors, see accessories

accessories

| | |
|------------------|--------------|
| mounting ø 17 mm | HI17-1H |
| reflector | FTDR 051E051 |

for details, see accessories section

remarks

Sensor FDA compliant, EHEDG certified and Ecolab approved
LSR = Liquid Silicon Rubber

| order reference | connection types | output circuit |
|--------------------|---------------------------------|----------------|
| FPDH 14N5101 | cable 4 pin, 2 m | NPN |
| FPDH 14N5101/KS34A | flylead connector M12, L=300 mm | NPN |
| FPDH 14P5101 | cable 4 pin, 2 m | PNP |
| FPDH 14P5101/KS34A | flylead connector M12, L=300 mm | PNP |

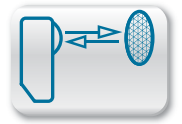

dimension drawings

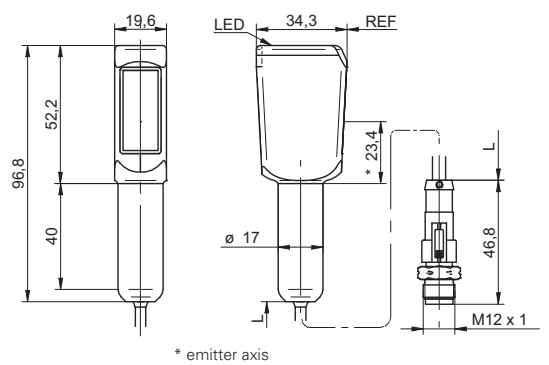
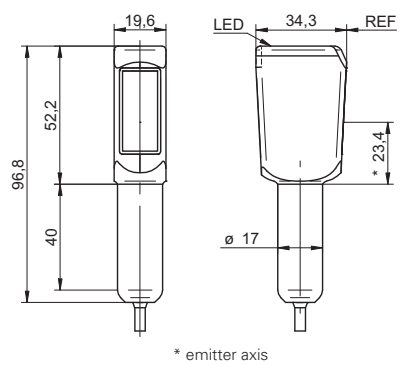

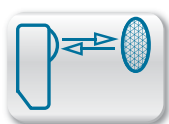

Sb = 3 m

- washdown design
- Ecolab approved

general data

| | |
|-------------------------------------|--------------------------|
| type | retro-reflective sensor |
| special type | Washdown design |
| light source | pulsed red LED |
| actual range Sb | 3 m |
| nominal range Sn | 3,5 m |
| polarization filter | yes |
| alignment / soiled lens indicator | flashing light indicator |
| light indicator | LED yellow |
| sensitivity adjustment | no |
| wave length | 660 nm |
| suppression of reciprocal influence | yes |
| Approvals/certificates | Ecolab |

electrical data

| | |
|------------------------------------|----------------------|
| response time / release time | < 1 ms |
| voltage supply range +Vs | 10 ... 30 VDC |
| current consumption max. (no load) | 25 mA |
| current consumption typ. | 20 mA |
| voltage drop Vd | < 1,8 VDC |
| output function | light / dark operate |
| output current | < 100 mA |
| short circuit protection | yes |
| reverse polarity protection | yes |

mechanical data

| | |
|------------------|-----------------------------------|
| width / diameter | 19,6 mm |
| height / length | 51 mm |
| depth | 34,3 mm |
| type | rectangular |
| housing material | stainless steel 1.4404 (V4A); LSR |
| front (optics) | PMMA |
| connection types | connector M12 |

ambient conditions

| | |
|-----------------------|----------------------|
| operating temperature | -30 ... +60 °C |
| protection class | IP 68/69K & proTect+ |
| storage temperature | -30 ... +70 °C |

order reference

| order reference | output circuit |
|------------------|----------------|
| FPDR 14N5101/S14 | NPN |
| FPDR 14P5101/S14 | PNP |



connection diagrams



connectors

| | | |
|--------------|-------|--------------|
| ESG 32AH0200 | 4 pin | 2 m straight |
| ESW 31AH0200 | 4 pin | 2 m angular |

additional cable connectors and field wireable connectors, see accessories

accessories

| | |
|-----------------------|--------------|
| SENSOFIX mounting kit | 11046279 |
| mounting bracket | 11046278 |
| reflector | FTDR 051E051 |

for details, see accessories section

remarks

Sensor FDA compliant and Ecolab approved
LSR = Liquid Silicon Rubber

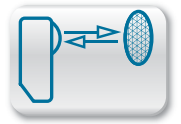

dimension drawing

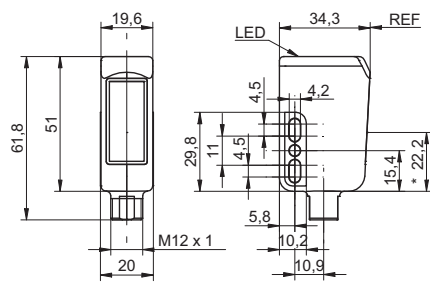

* emitter axis

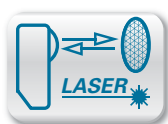

Sb = 10 m

- single lens optics
- long sensing range
- short response time

general data

| | |
|-----------------------------------|-------------------------------|
| type | retro-reflective laser sensor |
| version | single lens optics |
| light source | pulsed red laser diode |
| actual range Sb | 10 m |
| nominal range Sn | 11 m |
| repeat accuracy | < 0,1 mm at laser focus |
| polarization filter | yes |
| alignment / soiled lens indicator | flashing light indicator |
| light indicator | LED yellow |
| power on indication | LED green |
| sensitivity adjustment | Teach-in |
| laser class | 1 |
| distance to focus | 400 mm |
| wave length | 650 nm |

electrical data

| | |
|------------------------------------|----------------------|
| response time / release time | < 0,25 ms |
| voltage supply range +Vs | 10 ... 30 VDC |
| current consumption max. (no load) | 35 mA |
| current consumption typ. | 25 mA |
| voltage drop Vd | < 2,2 VDC |
| output function | light / dark operate |
| output circuit | PNP |
| output current | < 100 mA |
| short circuit protection | yes |
| reverse polarity protection | yes |

mechanical data

| | |
|------------------|---------------------|
| width / diameter | 14,8 mm |
| height / length | 43 mm |
| depth | 31 mm |
| type | rectangular |
| housing material | plastic (ASA, MABS) |
| front (optics) | PMMA |

ambient conditions

| | |
|-----------------------|----------------|
| operating temperature | -10 ... +50 °C |
| protection class | IP 67 |

order reference**connection types**

| | |
|-------------------|---------------------|
| OPDK 14P5901 | cable 4 pin, 2 m |
| OPDK 14P5901/S14 | connector M12 4 pin |
| OPDK 14P5901/S35A | connector M8 4 pin |

**connection diagrams****connectors**

| | | |
|--------------|-------|--------------|
| ESG 32AH0200 | 4 pin | 2 m straight |
| ESW 31AH0200 | 4 pin | 2 m angular |

additional cable connectors and field wireable connectors, see accessories

accessories

| | |
|-----------------------|----------|
| SENSOFIX mounting kit | 10149011 |
| mounting bracket | 10134964 |

for details, see accessories section

laser warning

**CLASS 1 LASER
PRODUCT**

Complies with 21 CFR 1040.10 and 1040.11
except for deviations pursuant to laser
notice No. 50, dated June 24, 2007

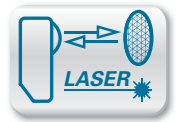

excess gain curves

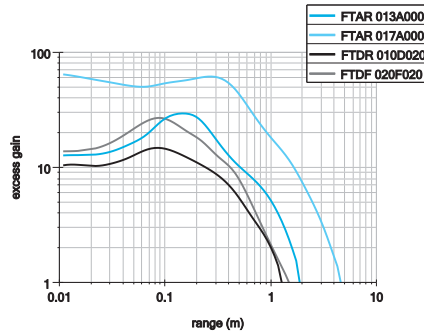
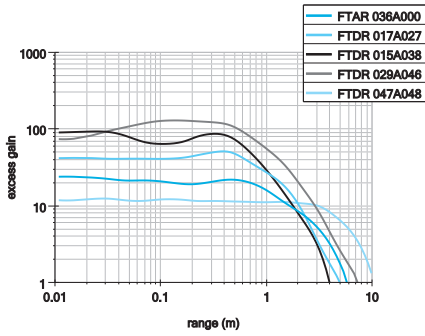

reflectors

| | | |
|--------------|--------------|------------|
| FTAR 013A000 | ∅ 15 mm | Sn = 1,9 m |
| FTAR 017A000 | ∅ 20,7 mm | Sn = 4,4 m |
| FTAR 036A000 | ∅ 46 mm | Sn = 5,8 m |
| FTDR 010D020 | 15 x 25 mm | Sn = 1,1 m |
| FTDR 017A027 | 20 x 42 mm | Sn = 5 m |
| FTDR 015A038 | 18 x 40 mm | Sn = 4 m |
| FTDR 029A046 | 32,5 x 48 mm | Sn = 7,2 m |
| FTDR 047A048 | 54 x 75 mm | Sn = 11 m |
| FTDF 020F020 | 20 x 20 mm | Sn = 1,2 m |

beam characteristic (typically)

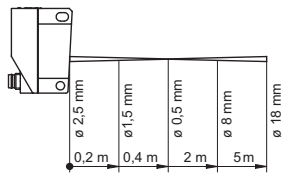

dimension drawings

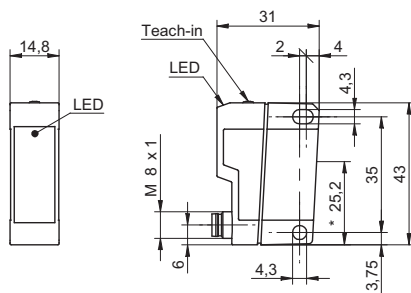

* emitter and receiver axis

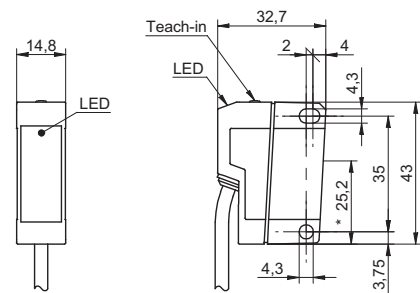

* emitter and receiver axis

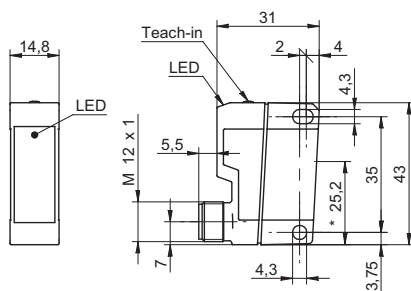

* emitter and receiver axis

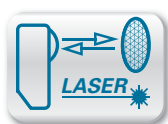

S_b = 4,5 m

- designed for detection of transparent objects
- single lens optics
- short response time



general data

| | |
|------------------------------|---|
| type | retro-reflective laser sensor |
| version | for transparent objects single lens optics |
| light source | pulsed red laser diode |
| actual range S _b | 4,5 m |
| nominal range S _n | 5,2 m |
| repeat accuracy | < 0,1 mm at laser focus |
| polarization filter | yes |
| light indicator | LED yellow |
| power on indication | LED green |
| sensitivity adjustment | Teach-in |
| laser class | 1 |
| distance to focus | 100 mm |
| wave length | 650 nm |

electrical data

| | |
|------------------------------------|---------------|
| response time / release time | < 0,25 ms |
| voltage supply range +Vs | 10 ... 30 VDC |
| current consumption max. (no load) | 35 mA |
| current consumption typ. | 25 mA |
| voltage drop V _d | < 2,2 VDC |
| output circuit | PNP |
| output current | < 100 mA |
| short circuit protection | yes |
| reverse polarity protection | yes |

mechanical data

| | |
|------------------|---------------------|
| width / diameter | 14,8 mm |
| height / length | 43 mm |
| depth | 31 mm |
| type | rectangular |
| housing material | plastic (ASA, MABS) |
| front (optics) | PMMA |

ambient conditions

| | |
|-----------------------|----------------|
| operating temperature | -10 ... +50 °C |
| protection class | IP 67 |

connection diagrams



connectors

| | | |
|--------------|-------|--------------|
| ESG 32AH0200 | 4 pin | 2 m straight |
| ESW 31AH0200 | 4 pin | 2 m angular |

additional cable connectors and field wireable connectors, see accessories

accessories

| | |
|-----------------------|----------|
| SENSOFIX mounting kit | 10149011 |
| mounting bracket | 10134964 |

for details, see accessories section

laser warning



Complies with 21 CFR 1040.10 and 1040.11 except for deviations pursuant to laser notice No. 50, dated June 24, 2007

| order reference | connection types | output function | teach value stored after power-off |
|-------------------|---------------------|-----------------|------------------------------------|
| OPDK 14P1902 | cable 4 pin, 2 m | light operate | volatile |
| OPDK 14P1902/S14 | connector M12 4 pin | light operate | volatile |
| OPDK 14P1902/S35A | connector M8 4 pin | light operate | volatile |
| OPDK 14P1903 | cable 4 pin, 2 m | light operate | non volatile |
| OPDK 14P1903/S14 | connector M12 4 pin | light operate | non volatile |
| OPDK 14P1903/S35A | connector M8 4 pin | light operate | non volatile |
| OPDK 14P3902 | cable 4 pin, 2 m | dark operate | volatile |
| OPDK 14P3902/S14 | connector M12 4 pin | dark operate | volatile |
| OPDK 14P3902/S35A | connector M8 4 pin | dark operate | volatile |
| OPDK 14P3903 | cable 4 pin, 2 m | dark operate | non volatile |
| OPDK 14P3903/S14 | connector M12 4 pin | dark operate | non volatile |
| OPDK 14P3903/S35A | connector M8 4 pin | dark operate | non volatile |

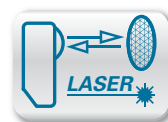

excess gain curves

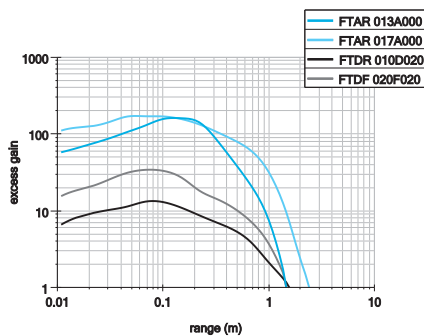
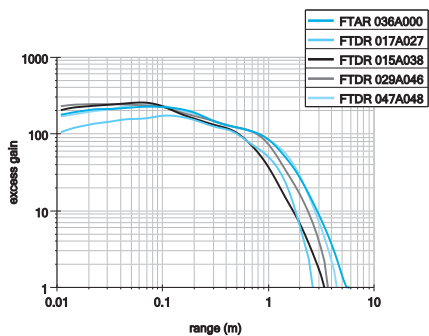

reflectors

| | | |
|--------------|--------------|------------|
| FTAR 013A000 | ∅ 15 mm | Sn = 1,4 m |
| FTAR 017A000 | ∅ 20,7 mm | Sn = 2,2 m |
| FTAR 036A000 | ∅ 46 mm | Sn = 4,2 m |
| FTDR 010D020 | 15 x 25 mm | Sn = 1,4 m |
| FTDR 017A027 | 20 x 42 mm | Sn = 2,6 m |
| FTDR 015A038 | 18 x 40 mm | Sn = 3,2 m |
| FTDR 029A046 | 32,5 x 48 mm | Sn = 3,6 m |
| FTDR 047A048 | 54 x 75 mm | Sn = 5,2 m |
| FTDF 020F020 | 20 x 20 mm | Sn = 1,4 m |

beam characteristic (typically)

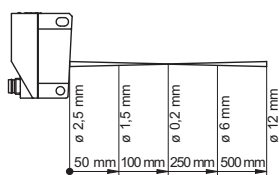

dimension drawings

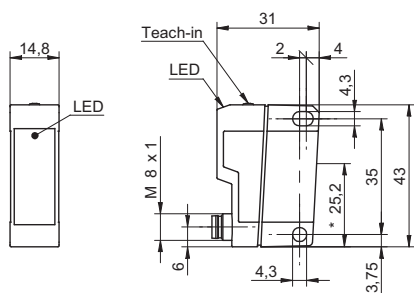

* emitter and receiver axis

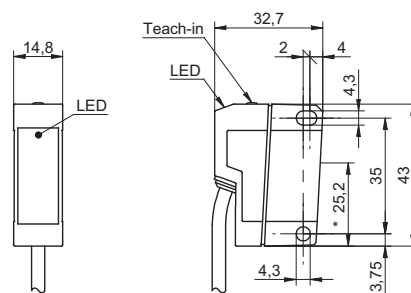

* emitter and receiver axis

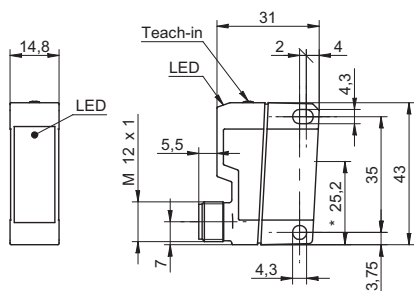

* emitter and receiver axis

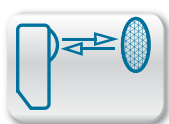

S_b = 7,3 m

- rugged metal housing
- sensing range adjustable via potentiometer
- polarization filter to detect shiny objects

general data

| | |
|-------------------------------------|--------------------------|
| type | retro-reflective sensor |
| light source | pulsed red LED |
| actual range S _b | 7,3 m |
| nominal range S _n | 8,5 m |
| polarization filter | yes |
| alignment / soiled lens indicator | flashing light indicator |
| light indicator | LED yellow |
| wave length | 660 nm |
| suppression of reciprocal influence | yes |

electrical data

| | |
|--------------------------------------|----------------------|
| response time / release time | < 1 ms |
| voltage supply range +V _s | 10 ... 30 VDC |
| current consumption max. (no load) | 36 mA |
| current consumption typ. | 26 mA |
| voltage drop V _d | < 1,8 VDC |
| output function | light / dark operate |
| output current | < 200 mA |
| short circuit protection | yes |
| reverse polarity protection | yes |

mechanical data

| | |
|------------------|---------------|
| width / diameter | 15,4 mm |
| height / length | 50 mm |
| depth | 50 mm |
| type | rectangular |
| housing material | die-cast zinc |
| front (optics) | PMMA |

ambient conditions

| | |
|-----------------------|----------------|
| operating temperature | -25 ... +65 °C |
| protection class | IP 67 |



connection diagrams



connectors

| | | |
|--------------|-------|--------------|
| ESG 34AH0200 | 4 pin | 2 m straight |
| ESW 33AH0200 | 4 pin | 2 m angular |

additional cable connectors and field wireable connectors, see accessories

accessories

| | |
|----------------------------------|----------|
| <i>SENSOFIX</i> mounting kit | 10151721 |
| mounting bracket | 10113917 |
| lens cleaning air nozzle bracket | 10116407 |

for details, see accessories section

| order reference | connection types | output circuit | sensitivity adjustment |
|------------------|---------------------|----------------|------------------------|
| FPDM 16N5101 | cable 4 pin, 2 m | NPN | no |
| FPDM 16N5101/S14 | connector M12 4 pin | NPN | no |
| FPDM 16P5101 | cable 4 pin, 2 m | PNP | no |
| FPDM 16P5101/S14 | connector M12 4 pin | PNP | no |
| FPDM 16P5105 | cable 4 pin, 2 m | PNP | potentiometer, 10 turn |
| FPDM 16P5105/S14 | connector M12 4 pin | PNP | potentiometer, 10 turn |

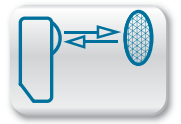

excess gain curves

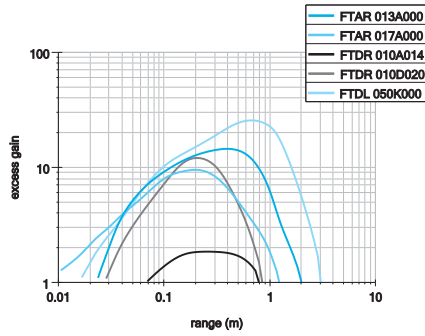
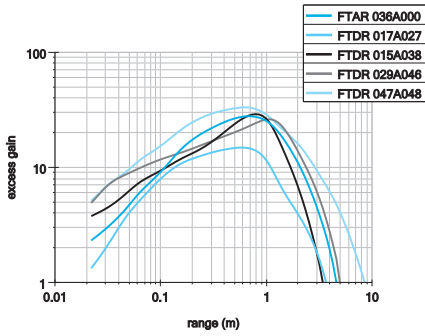

reflectors

| | | |
|--------------------|------------------|------------|
| FTAR 013A000 | ø 15 mm | Sn = 2 m |
| FTAR 017A000 | ø 20,7 mm | Sn = 1,1 m |
| FTAR 036A000 | ø 46 mm | Sn = 4,5 m |
| FTDR 010D014 | 12,8 x 16,8 mm | Sn = 0,8 m |
| FTDR 010D020 | 15 x 25 mm | Sn = 0,8 m |
| FTDR 017A027 | 20 x 42 mm | Sn = 3,6 m |
| FTDR 015A038 | 18 x 40 mm | Sn = 3,2 m |
| FTDR 029A046 | 32,5 x 48 mm | Sn = 5 m |
| FTDR 047A048 | 54 x 75 mm | Sn = 8,5 m |
| FTDL 050K000/... m | tape 50 x ... mm | Sn = 3 m |

dimension drawings

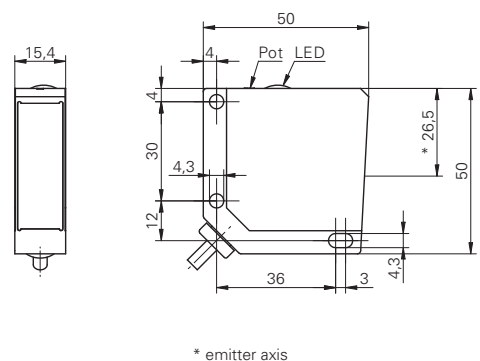
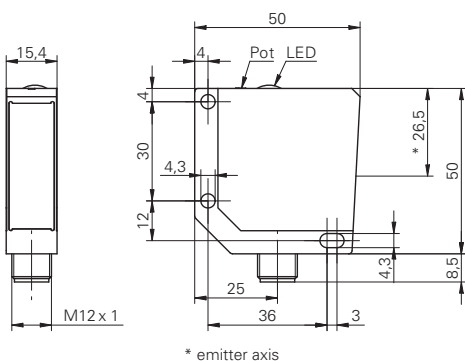
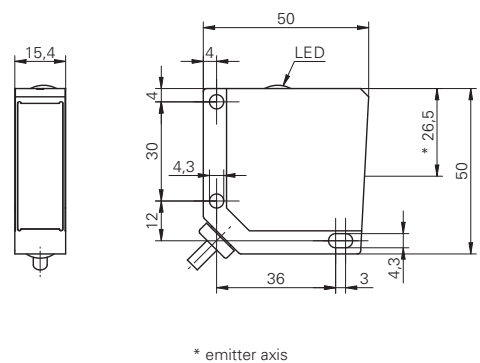
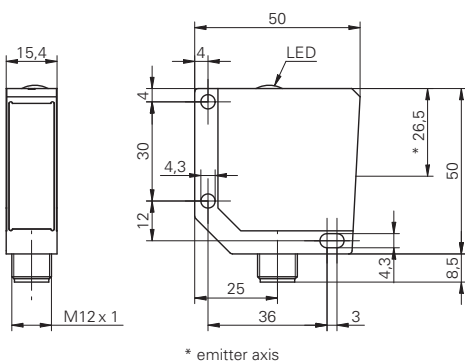

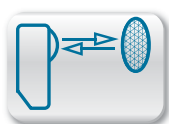

Sb = 6 m

- rugged metal housing
- designed for detection of transparent objects
- sensitivity adjustable via Teach-in

general data

| | |
|------------------------|-------------------------|
| type | retro-reflective sensor |
| version | for transparent objects |
| light source | pulsed red LED |
| actual range Sb | 6 m |
| nominal range Sn | 7,2 m |
| polarization filter | yes |
| light indicator | LED yellow |
| sensitivity adjustment | Teach-in |
| wave length | 660 nm |

electrical data

| | |
|------------------------------------|---------------|
| response time / release time | < 2,5 ms |
| adaption time | < 25 ms |
| voltage supply range +Vs | 10 ... 30 VDC |
| current consumption max. (no load) | 50 mA |
| current consumption typ. | 40 mA |
| voltage drop Vd | < 1,8 VDC |
| output function | dark operate |
| output circuit | PNP |
| output current | < 200 mA |
| short circuit protection | yes |
| reverse polarity protection | yes |

mechanical data

| | |
|------------------|---------------------|
| width / diameter | 15,4 mm |
| height / length | 50 mm |
| depth | 50 mm |
| type | rectangular |
| housing material | die-cast zinc |
| front (optics) | PMMA |
| connection types | connector M12 4 pin |

ambient conditions

| | |
|-----------------------|----------------|
| operating temperature | -25 ... +65 °C |
| protection class | IP 67 |

order reference

FPDM 16P3921/S14

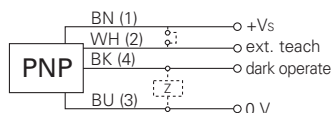
**connection diagram****connectors**

| | | |
|--------------|-------|--------------|
| ESG 34AH0200 | 4 pin | 2 m straight |
| ESW 33AH0200 | 4 pin | 2 m angular |

additional cable connectors and field wireable connectors, see accessories

accessories

| | |
|----------------------------------|----------|
| SENSOFIX mounting kit | 10151721 |
| mounting bracket | 10113917 |
| lens cleaning air nozzle bracket | 10116407 |

for details, see accessories section

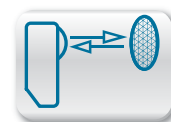

excess gain curves

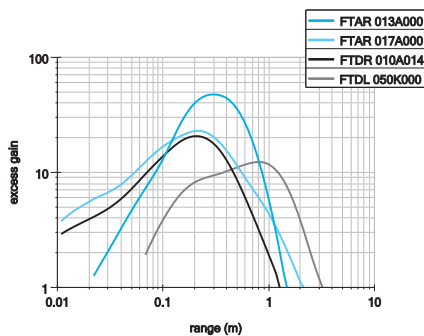
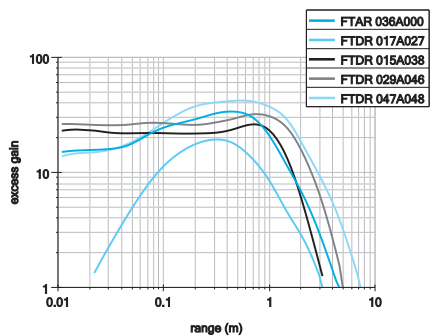

reflectors

| | | |
|--------------------|------------------|------------|
| FTAR 013A000 | ∅ 15 mm | Sn = 1,5 m |
| FTAR 017A000 | ∅ 20,7 mm | Sn = 2,1 m |
| FTAR 036A000 | ∅ 46 mm | Sn = 4,6 m |
| FTDR 010D014 | 12,8 x 16,8 mm | Sn = 1,3 m |
| FTDR 017A027 | 20 x 42 mm | Sn = 3,1 m |
| FTDR 015A038 | 18 x 40 mm | Sn = 3,2 m |
| FTDR 029A046 | 32,5 x 48 mm | Sn = 5 m |
| FTDR 047A048 | 54 x 75 mm | Sn = 7,2 m |
| FTDL 050K000/... m | tape 50 x ... mm | Sn = 3 m |

dimension drawing

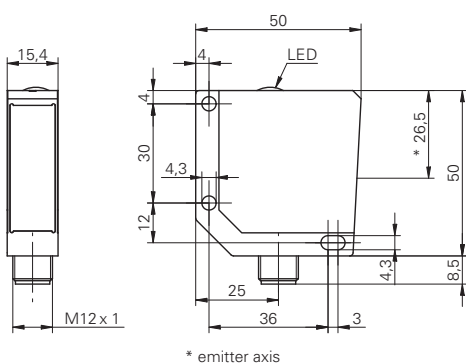

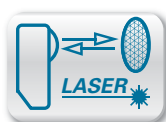

Sb = 11 m

- rugged metal housing
- high repeatability
- short response time

| general data | |
|------------------------------------|-------------------------------|
| type | retro-reflective laser sensor |
| light source | pulsed red laser diode |
| polarization filter | yes |
| alignment / soiled lens indicator | flashing light indicator |
| light indicator | LED yellow |
| laser class | 1 |
| wave length | 650 nm |
| actual range Sb = 7,5 m | |
| nominal range Sn | 8,3 m |
| repeat accuracy | < 0,1 mm at laser focus |
| sensitivity adjustment | potentiometer, 270° |
| distance to focus | 80 mm |
| actual range Sb = 11 m | |
| nominal range Sn | 12 m |
| repeat accuracy | < 1,5 mm at 0 ... 0,5 m |
| sensitivity adjustment | no |
| distance to focus | 400 mm |
| electrical data | |
| response time / release time | < 0,1 ms |
| voltage supply range +Vs | 10 ... 30 VDC |
| current consumption max. (no load) | 70 mA |
| current consumption typ. | 60 mA |
| voltage drop Vd | < 2 VDC |
| output function | light / dark operate |
| output circuit | PNP |
| output current | < 200 mA |
| short circuit protection | yes |
| reverse polarity protection | yes |
| mechanical data | |
| width / diameter | 15,4 mm |
| height / length | 50 mm |
| depth | 50 mm |
| type | rectangular |
| housing material | die-cast zinc |
| front (optics) | glass |
| ambient conditions | |
| operating temperature | -10 ... +50 °C |
| protection class | IP 67 |

| order reference | actual range Sb | connection types |
|------------------|-----------------|---------------------|
| OPDM 16P5102 | 11 m | cable 4 pin, 2 m |
| OPDM 16P5102/S14 | 11 m | connector M12 4 pin |
| OPDM 16P5103/S14 | 7,5 m | connector M12 4 pin |



connection diagram

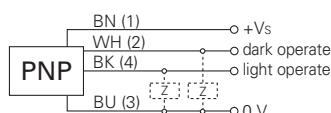

connectors

| | | |
|--------------|-------|--------------|
| ESG 34AH0200 | 4 pin | 2 m straight |
| ESW 33AH0200 | 4 pin | 2 m angular |

additional cable connectors and field wireable connectors, see accessories

accessories

| | |
|----------------------------------|----------|
| SENSOFIX mounting kit | 10151721 |
| mounting bracket | 10113917 |
| lens cleaning air nozzle bracket | 10116407 |

for details, see accessories section

laser warning

**CLASS 1 LASER
PRODUCT**

Complies with 21 CFR 1040.10 and 1040.11
except for deviations pursuant to laser
notice No. 50, dated June 24, 2007

excess gain curves

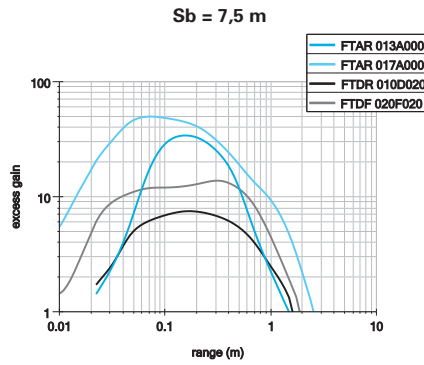
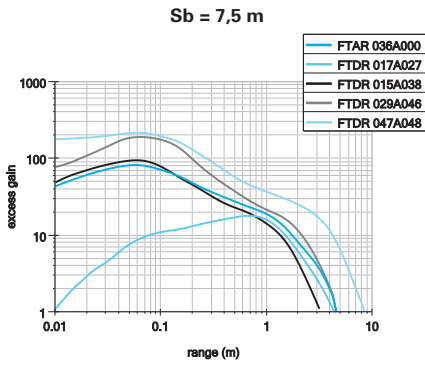
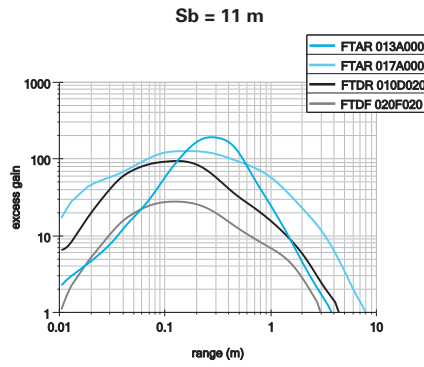
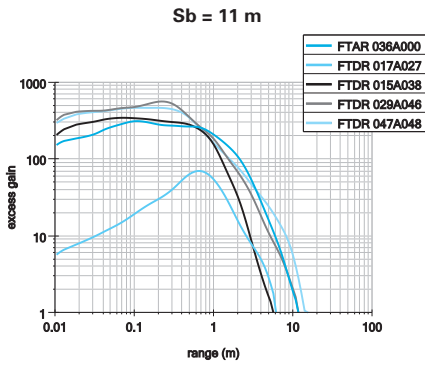

reflectors

| | | |
|--------------|--------------|------------|
| FTAR 013A000 | ∅ 15 mm | Sn = 1,3 m |
| FTAR 017A000 | ∅ 20,7 mm | Sn = 2,4 m |
| FTAR 036A000 | ∅ 46 mm | Sn = 4,4 m |
| FTDR 010D020 | 15 x 25 mm | Sn = 1,4 m |
| FTDR 017A027 | 20 x 42 mm | Sn = 4,4 m |
| FTDR 015A038 | 18 x 40 mm | Sn = 3,1 m |
| FTDR 029A046 | 32,5 x 48 mm | Sn = 4,4 m |
| FTDR 047A048 | 54 x 75 mm | Sn = 8,3 m |
| FTDF 020F020 | 20 x 20 mm | Sn = 1,8 m |

| | | |
|--------------|--------------|------------|
| FTAR 013A000 | ∅ 15 mm | Sn = 3,8 m |
| FTAR 017A000 | ∅ 20,7 mm | Sn = 8 m |
| FTAR 036A000 | ∅ 46 mm | Sn = 11 m |
| FTDR 010D020 | 15 x 25 mm | Sn = 4,2 m |
| FTDR 017A027 | 20 x 42 mm | Sn = 6 m |
| FTDR 015A038 | 18 x 40 mm | Sn = 5,5 m |
| FTDR 029A046 | 32,5 x 48 mm | Sn = 11 m |
| FTDR 047A048 | 54 x 75 mm | Sn = 12 m |
| FTDF 020F020 | 20 x 20 mm | Sn = 3 m |

beam characteristics (typically)

Sb = 11 m

Sb = 7,5 m

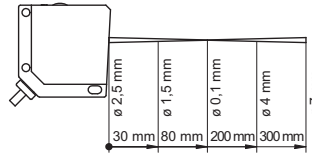
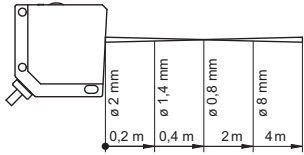

dimension drawings

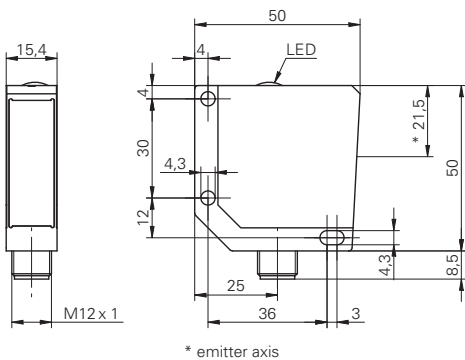

* emitter axis

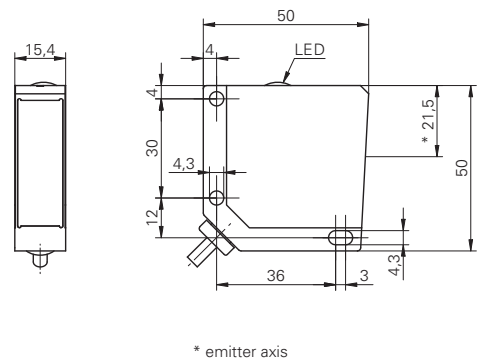

* emitter axis

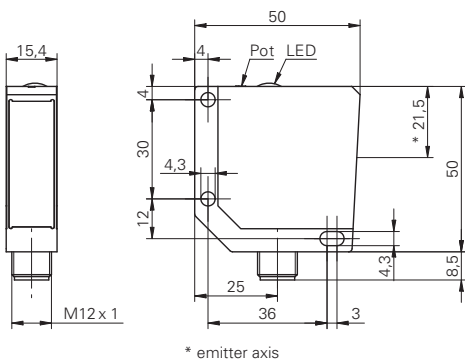

* emitter axis

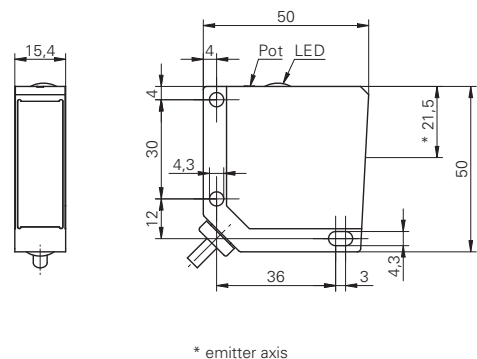

* emitter axis

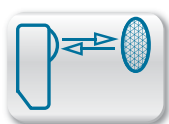

S_b = 3,2 m

- rugged metal housing
- polarization filter to detect shiny objects

general data

| | |
|-------------------------------------|--------------------------|
| type | retro-reflective sensor |
| light source | pulsed red LED |
| actual range S _b | 3,2 m |
| nominal range S _n | 4 m |
| polarization filter | yes |
| alignment / soiled lens indicator | flashing light indicator |
| light indicator | LED yellow |
| sensitivity adjustment | no |
| wave length | 660 nm |
| suppression of reciprocal influence | yes |

electrical data

| | |
|------------------------------------|---------------|
| response time / release time | < 1 ms |
| voltage supply range +Vs | 10 ... 30 VDC |
| current consumption max. (no load) | 35 mA |
| current consumption typ. | 22 mA |
| voltage drop V _d | < 1,8 VDC |
| output function | dark operate |
| output current | < 200 mA |
| short circuit protection | yes |
| reverse polarity protection | yes |

mechanical data

| | |
|------------------|--------------------------|
| width / diameter | 18 mm |
| type | cylindrical |
| housing material | brass nickel plated / PC |
| front (optics) | PMMA |

ambient conditions

| | |
|-----------------------|----------------|
| operating temperature | -25 ... +55 °C |
| protection class | IP 67 |



connection diagrams

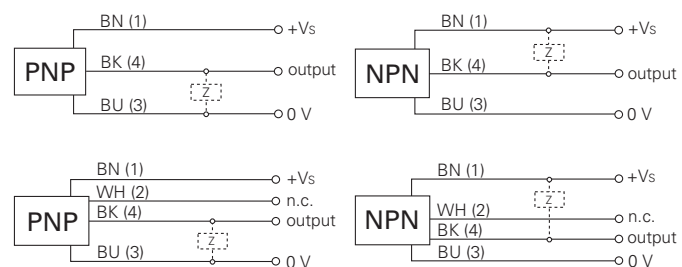

connectors

| | | |
|--------------|-------|--------------|
| ESG 34AH0200 | 4 pin | 2 m straight |
| ESW 33AH0200 | 4 pin | 2 m angular |

additional cable connectors and field wireable connectors, see accessories

accessories

| | |
|-----------------------|----------|
| SENSOFIX mounting kit | 10151658 |
| glass cover | 10103068 |
| doubling lens | 10107408 |
| cap nut | 10101480 |

for details, see accessories section

| order reference | connection types | height / length | output circuit |
|------------------|---------------------|-----------------|----------------|
| FPAM 18N3151 | cable 3 pin, 2 m | 57 mm | NPN |
| FPAM 18N3151/S14 | connector M12 4 pin | 67 mm | NPN |
| FPAM 18P3151 | cable 3 pin, 2 m | 57 mm | PNP |
| FPAM 18P3151/S14 | connector M12 4 pin | 67 mm | PNP |

FPAM 18 S_b = 3,2 m

Retro-reflective sensors

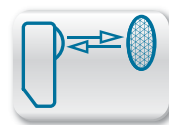

excess gain curves

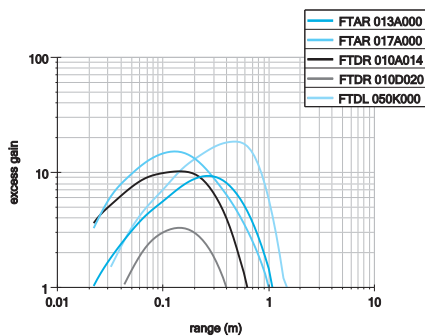
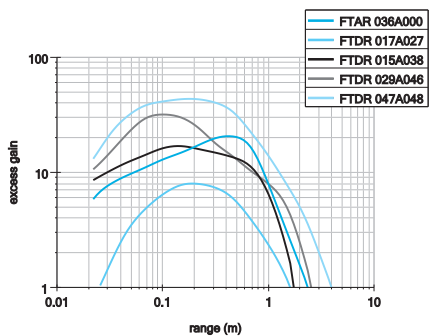

reflectors

| | | |
|--------------------|------------------|------------|
| FTAR 013A000 | ∅ 15 mm | Sn = 1,1 m |
| FTAR 017A000 | ∅ 20,7 mm | Sn = 1 m |
| FTAR 036A000 | ∅ 46 mm | Sn = 2,2 m |
| FTDR 010D014 | 12,8 x 16,8 mm | Sn = 0,6 m |
| FTDR 010D020 | 15 x 25 mm | Sn = 0,4 m |
| FTDR 017A027 | 20 x 42 mm | Sn = 1,6 m |
| FTDR 015A038 | 18 x 40 mm | Sn = 1,7 m |
| FTDR 029A046 | 32,5 x 48 mm | Sn = 2,3 m |
| FTDR 047A048 | 54 x 75 mm | Sn = 4 m |
| FTDL 050K000/... m | tape 50 x ... mm | Sn = 1,4 m |

dimension drawings

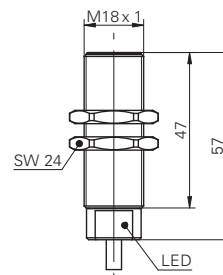
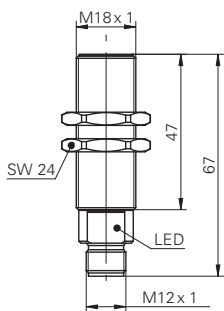

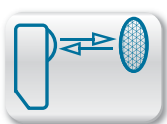

S_b = 5,5 m

- cross-technology housing concept
- polarization filter to detect shiny objects
- small mounting depth

general data

| | |
|-------------------------------------|--------------------------|
| type | retro-reflective sensor |
| light source | pulsed red LED |
| actual range S _b | 5,5 m |
| nominal range S _n | 6,8 m |
| polarization filter | yes |
| alignment / soiled lens indicator | flashing light indicator |
| light indicator | LED yellow |
| sensitivity adjustment | potentiometer, 270° |
| wave length | 660 nm |
| suppression of reciprocal influence | yes |

electrical data

| | |
|------------------------------------|----------------------|
| response time / release time | < 0,5 ms |
| voltage supply range +Vs | 10 ... 30 VDC |
| current consumption max. (no load) | 25 mA |
| current consumption typ. | 22 mA |
| voltage drop V _d | < 1,8 VDC |
| output function | light / dark operate |
| output current | < 100 mA |
| short circuit protection | yes |
| reverse polarity protection | yes |

mechanical data

| | |
|------------------|--------------------|
| width / diameter | 20 mm |
| height / length | 42 mm |
| depth | 15 mm |
| type | rectangular |
| housing material | plastic (PBT-ASA) |
| front (optics) | PMMA |
| connection types | connector M8 4 pin |

ambient conditions

| | |
|-----------------------|----------------|
| operating temperature | -25 ... +65 °C |
| protection class | IP 67 |

order reference

| | |
|-------------------|-----|
| FPDK 20N5101/S35A | NPN |
| FPDK 20P5101/S35A | PNP |

output circuit



connection diagrams



connectors

| | | |
|--------------|-------|--------------|
| ESG 32AH0200 | 4 pin | 2 m straight |
| ESW 31AH0200 | 4 pin | 2 m angular |

additional cable connectors and field wireable connectors, see accessories

accessories

| | |
|-----------------------|----------|
| SENSOFIX mounting kit | 10150326 |
|-----------------------|----------|

for details, see accessories section

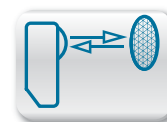

excess gain curves

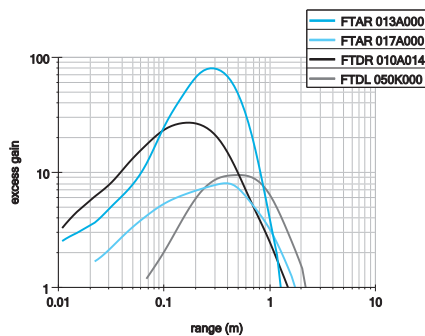
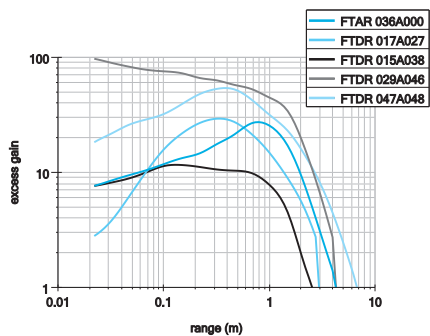

reflectors





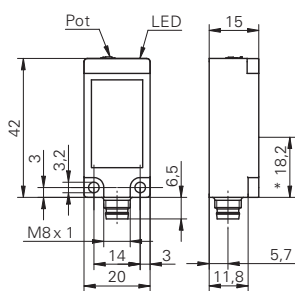

| | | |
|--------------------|------------------|------------|
| FTAR 013A000 | ∅ 15 mm | Sn = 1,2 m |
| FTAR 017A000 | ∅ 20,7 mm | Sn = 1,8 m |
| FTAR 036A000 | ∅ 46 mm | Sn = 4,2 m |
| FTDR 010D014 | 12,8 x 16,8 mm | Sn = 1,3 m |
| FTDR 017A027 | 20 x 42 mm | Sn = 3 m |
| FTDR 015A038 | 18 x 40 mm | Sn = 2,4 m |
| FTDR 029A046 | 32,5 x 48 mm | Sn = 4,2 m |
| FTDR 047A048 | 54 x 75 mm | Sn = 6,8 m |
| FTDL 050K000/... m | tape 50 x ... mm | Sn = 2,1 m |

dimension drawing









* emitter axis

red light LED version

| product family | FSCK 07 / FECK 07 | FSDK 07 / FEDK 07 | FSDM 08 / FEDM 08 | FSDM 08 / FEDM 08 | FSAM 08 / FEAM 08 | FSDK 10 / FEDK 10 | FSDM 12 / FEDM 12 |
|------------------------------|---|---|---|---|---|---|---|
| |  |  |  |  |  |  |  |
| width / diameter | 8 mm | 8 mm | 8 mm | 8 mm | 8 mm | 10,4 mm | 12,4 mm |
| actual range Sb | 2 m | 2 m | 0,7 m | 2,5 m | 2,5 m | 5 m | 6 m |
| response time / release time | < 0,5 ms | < 0,5 ms | < 2,5 ms | < 2,5 ms | < 2,5 ms | < 1,4 ms | < 1 ms |
| sensitivity adjustment | Teach-in | Teach-in | no | no | no | potentiometer, 270° | no |
| NPN | ■ | ■ | | | | ■ | |
| PNP | ■ | ■ | ■ | ■ | ■ | ■ | ■ |
| cable | ■ | ■ | ■ | ■ | ■ | ■ | ■ |
| flylead connector | ■ | ■ | | | | ■ | |
| connector | | | ■ | ■ | ■ | ■ | ■ |
| housing material | plastic | plastic | metal | metal | metal | plastic | metal |
| | | | | | | | |
| page | 254 | 256 | 258 | 260 | 262 | 264 | 268 |

laser version

| product family | OSDK 10 / OEDK 10 | OSDK 14 / OEDK 14 | OSDM 16 / OEDM 16 |
|------------------------------|---|---|---|
| |  |  |  |
| width / diameter | 10,4 mm | 14,8 mm | 15,4 mm |
| actual range Sb | 8 m | 8 m | 8 m |
| response time / release time | < 0,2 ms | < 0,5 ms | < 0,1 ms |
| sensitivity adjustment | potentiometer, 270° | no | potentiometer, 270° |
| NPN | ■ | | |
| PNP | ■ | ■ | ■ |
| cable | ■ | | ■ |
| connector | ■ | ■ | ■ |
| housing material | plastic | plastic | metal |
| page | 266 | 272 | 276 |

| FSDK 14 / FEDK 14 | FSDM 16 / FEDM 16 | FSAM 18 / FEAM 18 | FSDK 20 / FEDK 20 |
|---|---|---|---|
|  |  |  |  |
| 14,8 mm | 15,4 mm | 18 mm | 20 mm |
| 12 m | 3 m 8 m | 16 m | 6 m |
| < 1,2 ms | < 1 ms | < 1 ms | < 0,5 ms |
| no | no potentiometer, 10 turn | potentiometer, 270° | potentiometer, 270° |
| ■ | | ■ | ■ |
| ■ | ■ | ■ | ■ |
| | ■ | ■ | |
| ■ | ■ | ■ | ■ |
| plastic | metal | metal | plastic |
| | | | |
| 270 | 274 | 278 | 280 |



General information

An emitter in a separate housing transmits the light to a separate receiver. The object is detected when it breaks the emitted beam.

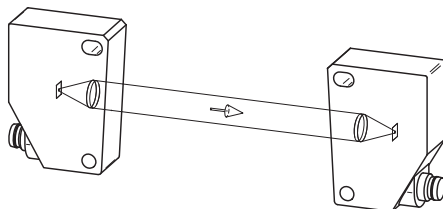

Applications

- Detection of objects at a great distance – through beam sensors have the longest ranges.
- Monitoring of doors and entrances
- Due to the good repeatability throughout the entire range, positioning of objects
- Reliable detection of high-gloss objects such as mirrors, wafers or chrome-plated surfaces

Characteristics and advantages

- Due to the separated configuration, long ranges with large signal excess gain can be achieved in comparison with equivalent retro-reflective systems. Through beam sensors are therefore most suitable for operation in unfavorable ambient conditions such as dirt, dust and moisture.
- The clearly defined, consistent active zone permits highly constant repeatability throughout the entire sensing distance.
- The switching point is independent of the surface properties of the object.



Technology and operation

The active area (A) of a through beam sensor is equal to the diameter of the lens of the receiver or emitter. The acceptance zone (B) of the emitter and receiver is larger. However, this is only important for adjustment and for operation close to glossy surfaces. With focused through beam laser sensors, the active area is the diameter of the laser beam if this is smaller than the receiver lens or the front opening at the receiver end.

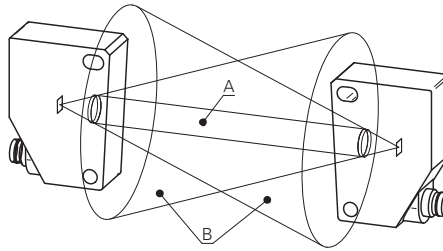

Mounting and adjustment

The emitter and receiver must be aimed at each other. The narrower the angle of radiation and reception, the more accurately this must be conducted.

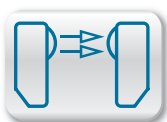

Sb = 2 m

- ultra compact housing
- sensing range adjustable via Teach-in
- test input

general data

| | |
|------------------|---------------------|
| type | through beam sensor |
| actual range Sb | 2 m |
| nominal range Sn | 2,5 m |

receiver

| | |
|-----------------------------------|--------------------------|
| alignment / soiled lens indicator | flashing light indicator |
| light indicator | LED green |
| output indicator | LED yellow |
| sensitivity adjustment | Teach-in |

emitter

| | |
|--------------|----------------|
| light source | pulsed red LED |
| wave length | 660 nm |

electrical data

| | |
|------------------------------------|---------------|
| voltage supply range +Vs | 10 ... 30 VDC |
| current consumption max. (no load) | 20 mA |
| reverse polarity protection | yes |

receiver

| | |
|------------------------------|----------------------|
| response time / release time | < 0,5 ms |
| current consumption typ. | 20 mA |
| voltage drop Vd | < 1,8 VDC |
| output function | light / dark operate |
| output current | < 100 mA |
| short circuit protection | yes |

emitter

| | |
|--------------------------|-------|
| current consumption typ. | 12 mA |
|--------------------------|-------|

mechanical data

| | |
|------------------|--------------------------|
| width / diameter | 8 mm |
| height / length | 16,2 mm |
| depth | 10,8 mm |
| type | rectangular |
| housing material | plastic (PMMA, MABS, PA) |
| front (optics) | PMMA |

ambient conditions

| | |
|-----------------------|----------------|
| operating temperature | -20 ... +50 °C |
| protection class | IP 65 |

| order reference | emitter / receiver | connection types | output circuit |
|--------------------|--------------------|----------------------------|----------------|
| FECK 07N6901 | receiver | cable rear side, 2 m | NPN |
| FECK 07N6901/KS35A | receiver | flylead connector M8 4 pin | NPN |
| FECK 07P6901 | receiver | cable rear side, 2 m | PNP |
| FECK 07P6901/KS35A | receiver | flylead connector M8 4 pin | PNP |
| FSCK 07D9601 | emitter | cable rear side, 2 m | - |
| FSCK 07D9601/KS35A | emitter | flylead connector M8 4 pin | - |

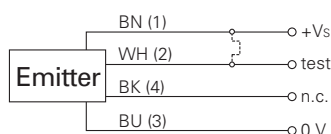
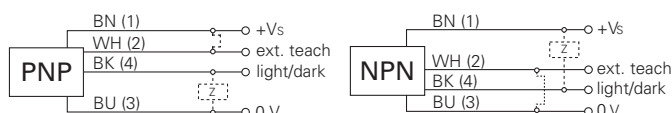
**connection diagrams****connectors**

| | | |
|--------------|-------|--------------|
| ESG 32AH0200 | 4 pin | 2 m straight |
| ESW 31AH0200 | 4 pin | 2 m angular |

additional cable connectors and field wireable connectors, see accessories

accessories

| | |
|----------------------|----------|
| MINOFIX mounting kit | 10150844 |
|----------------------|----------|

for details, see accessories section

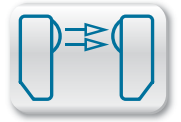

excess gain curve

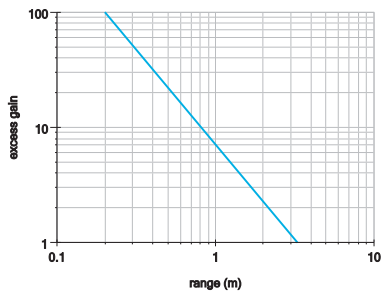

dimension drawings

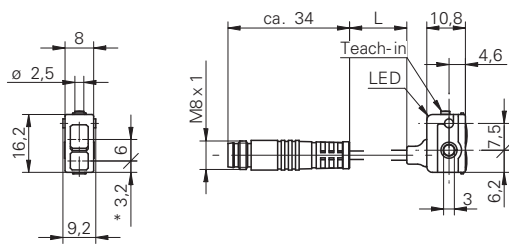

* receiver axis cable length L = 200 mm

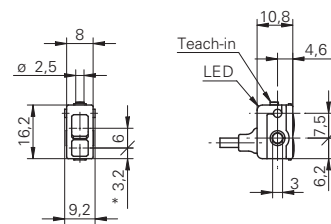

* receiver axis

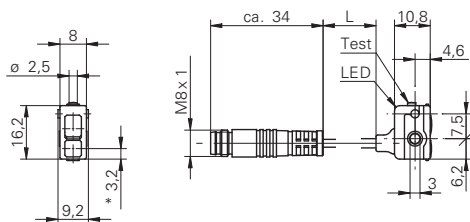

* emitter axis cable length L = 200 mm

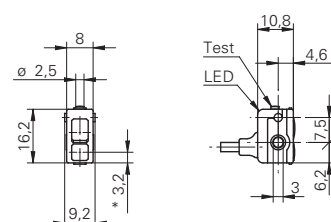

* emitter axis

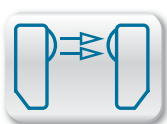

S_b = 2 m

- ultra compact housing
- sensing range adjustable via Teach-in
- test input

general data

| | |
|------------------------------|---------------------|
| type | through beam sensor |
| actual range S _b | 2 m |
| nominal range S _n | 2,5 m |

receiver

| | |
|-----------------------------------|--------------------------|
| alignment / soiled lens indicator | flashing light indicator |
| light indicator | LED green |
| output indicator | LED yellow |
| sensitivity adjustment | Teach-in |

emitter

| | |
|--------------|----------------|
| light source | pulsed red LED |
| wave length | 660 nm |

electrical data

| | |
|------------------------------------|---------------|
| voltage supply range +Vs | 10 ... 30 VDC |
| current consumption max. (no load) | 20 mA |
| reverse polarity protection | yes |

receiver

| | |
|------------------------------|----------------------|
| response time / release time | < 0,5 ms |
| current consumption typ. | 20 mA |
| voltage drop V _d | < 1,8 VDC |
| output function | light / dark operate |
| output current | < 100 mA |
| short circuit protection | yes |

emitter

| | |
|--------------------------|-------|
| current consumption typ. | 12 mA |
|--------------------------|-------|

mechanical data

| | |
|------------------|--------------------------|
| width / diameter | 8 mm |
| height / length | 16,2 mm |
| depth | 10,8 mm |
| type | rectangular |
| housing material | plastic (PMMA, MABS, PA) |
| front (optics) | PMMA |

ambient conditions

| | |
|-----------------------|----------------|
| operating temperature | -20 ... +50 °C |
| protection class | IP 65 |



connection diagrams

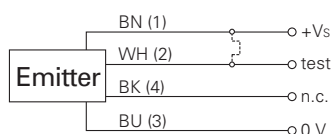

connectors

| | | |
|--------------|-------|--------------|
| ESG 32AH0200 | 4 pin | 2 m straight |
| ESW 31AH0200 | 4 pin | 2 m angular |

additional cable connectors and field wireable connectors, see accessories

accessories

| | |
|----------------------|----------|
| MINOFIX mounting kit | 10150844 |
|----------------------|----------|

for details, see accessories section

| order reference | emitter / receiver | connection types | output circuit |
|--------------------|--------------------|----------------------------|----------------|
| FEDK 07N6901 | receiver | cable bottom side, 2 m | NPN |
| FEDK 07N6901/KS35A | receiver | flylead connector M8 4 pin | NPN |
| FEDK 07P6901 | receiver | cable bottom side, 2 m | PNP |
| FEDK 07P6901/KS35A | receiver | flylead connector M8 4 pin | PNP |
| FSDK 07D9601 | emitter | cable bottom side, 2 m | - |
| FSDK 07D9601/KS35A | emitter | flylead connector M8 4 pin | - |

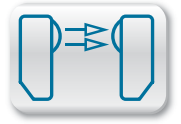

excess gain curve

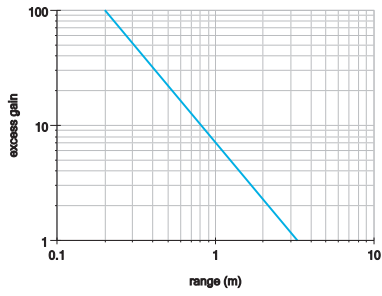

dimension drawings

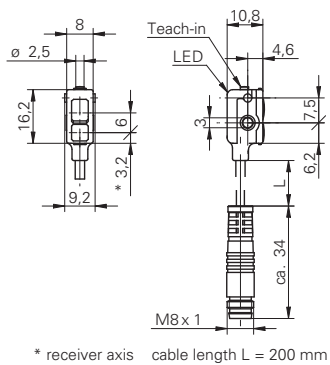

* receiver axis cable length L = 200 mm

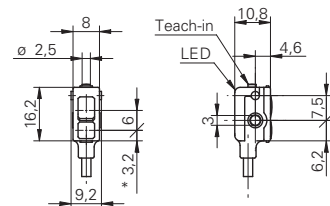

* receiver axis

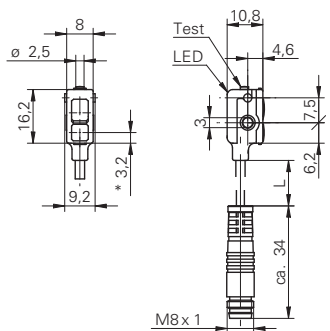

* emitter axis cable length L = 200 mm

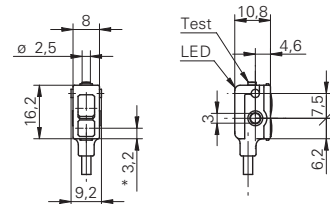

* emitter axis

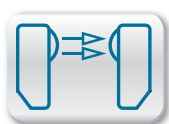

S_b = 0,7 m

- subminiature metal housing
- small rectangular design

general data

| | |
|------------------------------|---------------------|
| type | through beam sensor |
| actual range S _b | 0,7 m |
| nominal range S _n | 1 m |

receiver

| | |
|-----------------------------------|--------------------------|
| alignment / soiled lens indicator | flashing light indicator |
| light indicator | LED red |
| sensitivity adjustment | no |

emitter

| | |
|--------------|-----------------------|
| light source | pulsed infrared diode |
| wave length | 880 nm |

electrical data

| | |
|-----------------------------|---------------|
| voltage supply range +Vs | 10 ... 30 VDC |
| reverse polarity protection | yes |

receiver

| | |
|------------------------------------|----------|
| response time / release time | < 2,5 ms |
| current consumption max. (no load) | 24 mA |
| current consumption typ. | 24 mA |
| voltage drop V _d | < 2 VDC |
| output circuit | PNP |
| output current | < 100 mA |
| short circuit protection | yes |

emitter

| | |
|------------------------------------|-------|
| current consumption max. (no load) | 48 mA |
| current consumption typ. | 17 mA |

mechanical data

| | |
|------------------|-------------------|
| width / diameter | 8 mm |
| height / length | 58 mm |
| depth | 12 mm |
| type | rectangular |
| housing material | aluminum anodized |
| front (optics) | PC |

ambient conditions

| | |
|-----------------------|----------------|
| operating temperature | -25 ... +65 °C |
| protection class | IP 65 |



connection diagrams

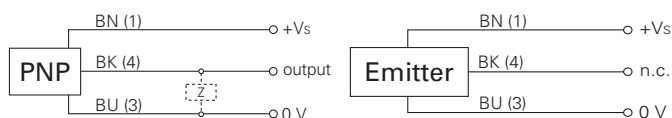

connectors

| | | |
|--------------|-------|--------------|
| ESG 32SH0200 | 3 pin | 2 m straight |
| ESW 31SH0200 | 3 pin | 2 m angular |

additional cable connectors and field wireable connectors, see accessories

accessories

| | |
|-----------------------|----------|
| SENSOFIX mounting kit | 10151719 |
|-----------------------|----------|

for details, see accessories section

| order reference | emitter / receiver | connection types | output function |
|-------------------|--------------------|---------------------|-----------------|
| FEDM 08P1001 | receiver | cable 3 pin, 2 m | light operate |
| FEDM 08P1001/S35L | receiver | connector M8, 3 pin | light operate |
| FEDM 08P3001 | receiver | cable 3 pin, 2 m | dark operate |
| FEDM 08P3001/S35L | receiver | connector M8, 3 pin | dark operate |
| FSDM 08D9001 | emitter | cable 3 pin, 2 m | - |
| FSDM 08D9001/S35 | emitter | connector M8, 3 pin | - |

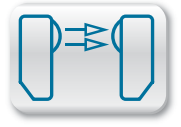

excess gain curve

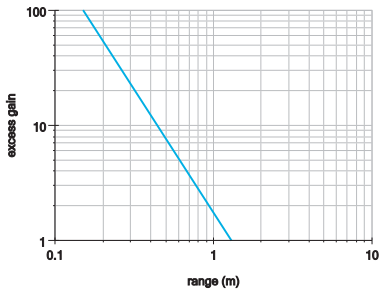

dimension drawings

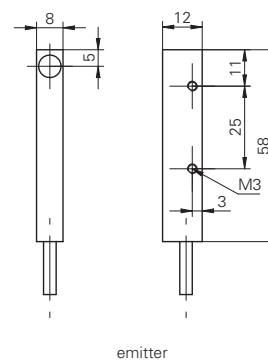
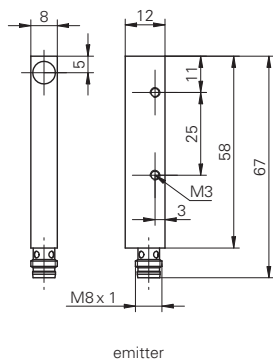
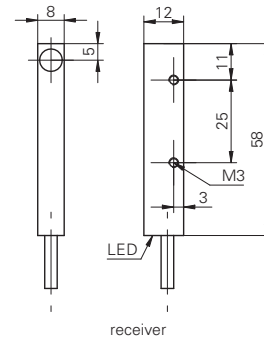
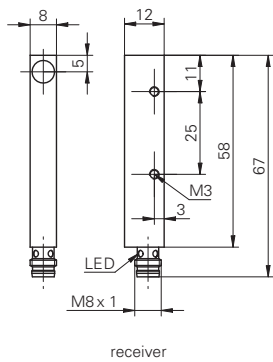

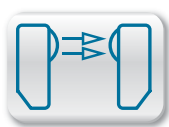

Sb = 2,5 m

- subminiature metal housing
- small rectangular design

general data

| | |
|------------------|---------------------|
| type | through beam sensor |
| actual range Sb | 2,5 m |
| nominal range Sn | 3 m |

receiver

| | |
|-----------------------------------|--------------------------|
| alignment / soiled lens indicator | flashing light indicator |
| light indicator | LED red |
| sensitivity adjustment | no |

emitter

| | |
|--------------|-----------------------|
| light source | pulsed infrared diode |
| wave length | 880 nm |

electrical data

| | |
|-----------------------------|---------------|
| voltage supply range +Vs | 10 ... 30 VDC |
| reverse polarity protection | yes |

receiver

| | |
|------------------------------------|----------|
| response time / release time | < 2,5 ms |
| current consumption max. (no load) | 24 mA |
| current consumption typ. | 24 mA |
| voltage drop Vd | < 2 VDC |
| output circuit | PNP |
| output current | < 100 mA |
| short circuit protection | yes |

emitter

| | |
|------------------------------------|-------|
| current consumption max. (no load) | 48 mA |
| current consumption typ. | 17 mA |

mechanical data

| | |
|------------------|-------------------|
| width / diameter | 8 mm |
| height / length | 58 mm |
| depth | 15 mm |
| type | rectangular |
| housing material | aluminum anodized |
| front (optics) | PC |

ambient conditions

| | |
|-----------------------|----------------|
| operating temperature | -25 ... +65 °C |
| protection class | IP 65 |

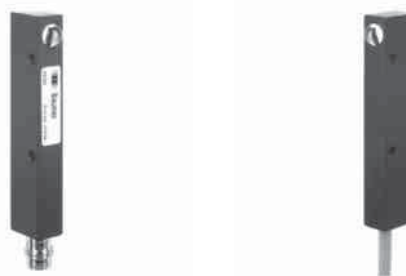

connection diagrams

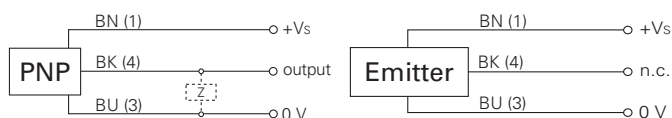

connectors

| | | |
|--------------|-------|--------------|
| ESG 32SH0200 | 3 pin | 2 m straight |
| ESW 31SH0200 | 3 pin | 2 m angular |

additional cable connectors and field wireable connectors, see accessories

accessories

| | |
|-----------------------|----------|
| SENSOFIX mounting kit | 10151719 |
|-----------------------|----------|

for details, see accessories section

| order reference | emitter / receiver | connection types | output function |
|-------------------|--------------------|---------------------|-----------------|
| FEDM 08P1002 | receiver | cable 3 pin, 2 m | light operate |
| FEDM 08P1002/S35L | receiver | connector M8, 3 pin | light operate |
| FEDM 08P3002 | receiver | cable 3 pin, 2 m | dark operate |
| FEDM 08P3002/S35L | receiver | connector M8, 3 pin | dark operate |
| FSDM 08D9002 | emitter | cable 3 pin, 2 m | - |
| FSDM 08D9002/S35 | emitter | connector M8, 3 pin | - |

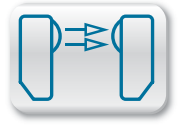

excess gain curve

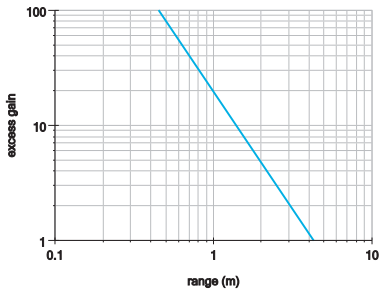

dimension drawings

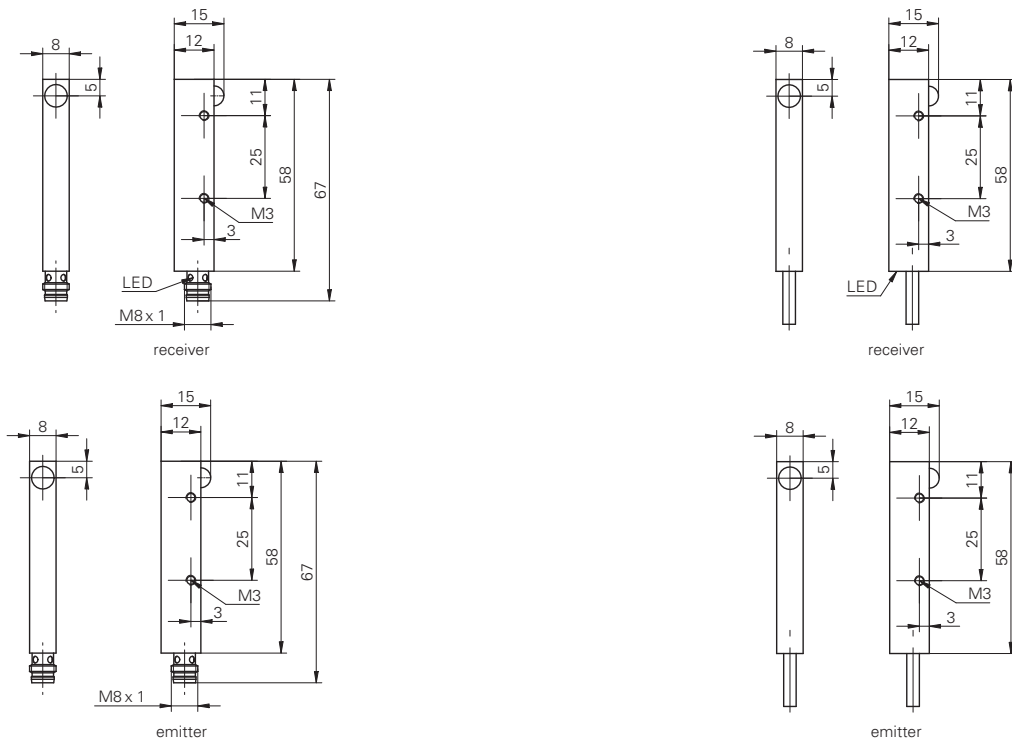

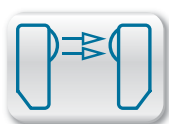

S_b = 2,5 m

- subminiature metal housing
- cylindrical design

general data

| | |
|------------------------------|---------------------|
| type | through beam sensor |
| actual range S _b | 2,5 m |
| nominal range S _n | 3 m |

receiver

| | |
|-----------------------------------|--------------------------|
| alignment / soiled lens indicator | flashing light indicator |
| light indicator | LED red |
| sensitivity adjustment | no |

emitter

| | |
|--------------|-----------------------|
| light source | pulsed infrared diode |
| wave length | 880 nm |

electrical data

| | |
|-----------------------------|---------------|
| voltage supply range +Vs | 10 ... 30 VDC |
| reverse polarity protection | yes |

receiver

| | |
|------------------------------------|----------|
| response time / release time | < 2,5 ms |
| current consumption max. (no load) | 24 mA |
| current consumption typ. | 24 mA |
| voltage drop V _d | < 2 VDC |
| output circuit | PNP |
| output current | < 100 mA |
| short circuit protection | yes |

emitter

| | |
|------------------------------------|-------|
| current consumption max. (no load) | 48 mA |
| current consumption typ. | 17 mA |

mechanical data

| | |
|------------------|---------------------|
| width / diameter | 8 mm |
| housing material | brass nickel plated |
| front (optics) | PC |

ambient conditions

| | |
|-----------------------|----------------|
| operating temperature | -25 ... +65 °C |
| protection class | IP 65 |



connection diagrams

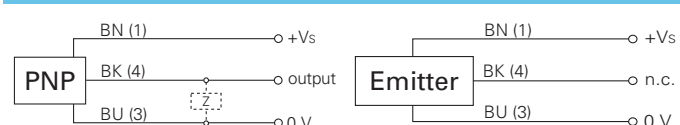

connectors

| | | |
|--------------|-------|--------------|
| ESG 32SH0200 | 3 pin | 2 m straight |
| ESW 31SH0200 | 3 pin | 2 m angular |

additional cable connectors and field wireable connectors, see accessories

accessories

| | |
|-----------------------|----------|
| SENSOFIX mounting kit | 10151719 |
|-----------------------|----------|

for details, see accessories section

| order reference | emitter / receiver | connection types | type | height / length | output function |
|-------------------|--------------------|---------------------|----------------------|-----------------|-----------------|
| FEAM 08P1002 | receiver | cable 3 pin, 2 m | cylindrical threaded | 59 mm | light operate |
| FEAM 08P1002/S35L | receiver | connector M8, 3 pin | cylindrical | 75,5 mm | light operate |
| FEAM 08P3002 | receiver | cable 3 pin, 2 m | cylindrical | 59 mm | dark operate |
| FEAM 08P3002/S35L | receiver | connector M8, 3 pin | cylindrical | 75,5 mm | dark operate |
| FSAM 08D9002 | emitter | cable 3 pin, 2 m | cylindrical | 59 mm | - |
| FSAM 08D9002/S35 | emitter | connector M8, 3 pin | cylindrical | 75,5 mm | - |

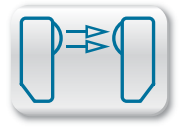

excess gain curve

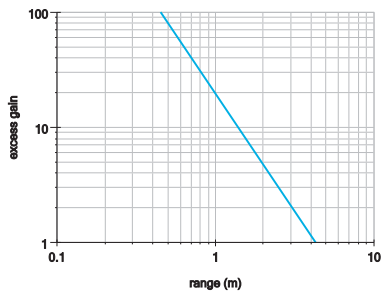

dimension drawings

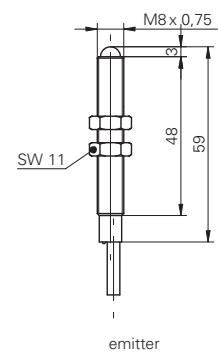
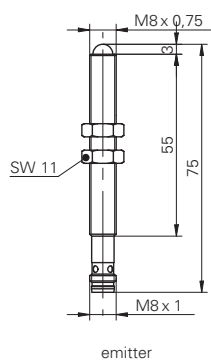
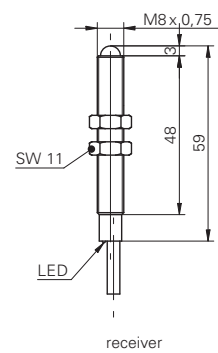
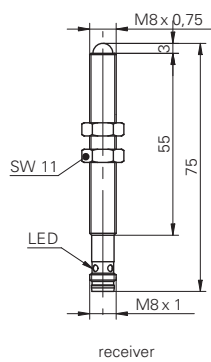

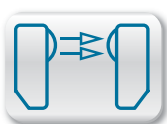

Sb = 5 m

- compact housing
- sensing range adjustable via potentiometer
- test input

general data

| | |
|------------------|---------------------|
| type | through beam sensor |
| actual range Sb | 5 m |
| nominal range Sn | 6 m |

receiver

| | |
|-----------------------------------|--------------------------|
| alignment / soiled lens indicator | flashing light indicator |
| light indicator | LED yellow |
| sensitivity adjustment | potentiometer, 270° |

emitter

| | |
|--------------|----------------|
| light source | pulsed red LED |
| wave length | 660 nm |

electrical data

| | |
|-----------------------------|---------------|
| voltage supply range +Vs | 10 ... 30 VDC |
| reverse polarity protection | yes |

receiver

| | |
|------------------------------------|-----------|
| response time / release time | < 1,4 ms |
| current consumption max. (no load) | 16 mA |
| current consumption typ. | 16 mA |
| voltage drop Vd | < 1,8 VDC |
| output current | < 100 mA |
| short circuit protection | yes |

emitter

| | |
|------------------------------------|-------|
| current consumption max. (no load) | 23 mA |
| current consumption typ. | 15 mA |

mechanical data

| | |
|------------------|---------------|
| width / diameter | 10,4 mm |
| height / length | 27 mm |
| depth | 14 mm |
| type | rectangular |
| housing material | plastic (ASA) |
| front (optics) | PMMA |

ambient conditions

| | |
|-----------------------|----------------|
| operating temperature | -25 ... +65 °C |
|-----------------------|----------------|

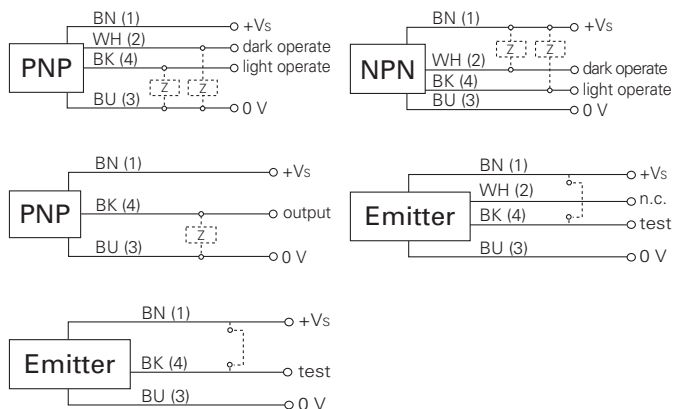
**connection diagrams****connectors**

| | | |
|--------------|-------|--------------|
| ESG 32SH0200 | 3 pin | 2 m straight |
| ESW 31SH0200 | 3 pin | 2 m angular |
| ESG 32AH0200 | 4 pin | 2 m straight |
| ESW 31AH0200 | 4 pin | 2 m angular |

additional cable connectors and field wireable connectors, see accessories

accessories

| | |
|-----------------------------------|----------|
| SENSOFIX mounting kit | 10150326 |
| mounting bracket (cable type) | 10114501 |
| mounting bracket (connector type) | 10133792 |

for details, see accessories section

| order reference | emitter / receiver | connection types | output circuit | output function | protection class |
|-------------------|--------------------|----------------------------|----------------|----------------------|------------------|
| FEDK 10N5101 | receiver | cable 4 pin, 2 m | NPN | light / dark operate | IP 65 |
| FEDK 10N5101/S35A | receiver | connector M8 4 pin | NPN | light / dark operate | IP 67 |
| FEDK 10P1101/KS35 | receiver | flylead connector M8 3 pin | PNP | light operate | IP 65 |
| FEDK 10P3101/KS35 | receiver | flylead connector M8 3 pin | PNP | dark operate | IP 65 |
| FEDK 10P5101 | receiver | cable 4 pin, 2 m | PNP | light / dark operate | IP 65 |
| FEDK 10P5101/S35A | receiver | connector M8 4 pin | PNP | light / dark operate | IP 67 |
| FSDK 10D9001/KS35 | emitter | flylead connector M8 3 pin | - | - | IP 65 |
| FSDK 10D9601 | emitter | cable 4 pin, 2 m | - | - | IP 65 |
| FSDK 10D9601/S35A | emitter | connector M8 4 pin | - | - | IP 67 |

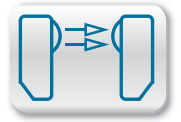

excess gain curve

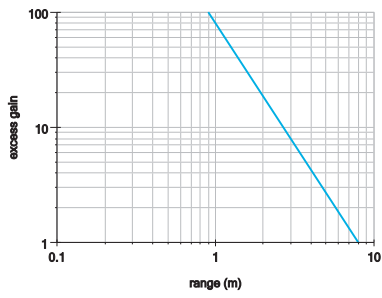

dimension drawings

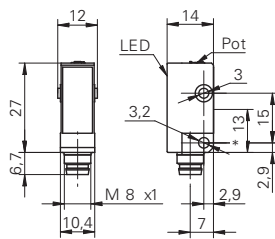

* receiver axis

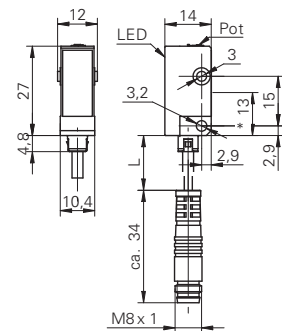

* receiver axis cable length L = 200 mm

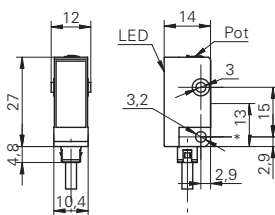

* receiver axis

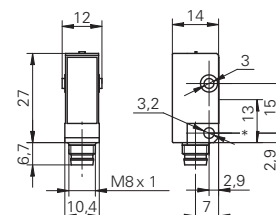

* emitter axis

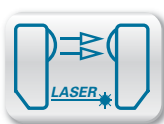

Sb = 8 m

- long range
- short response time

general data

| | |
|------------------|---------------------------|
| type | through beam laser sensor |
| actual range Sb | 8 m |
| nominal range Sn | 10 m |

receiver

| | |
|-----------------------------------|--------------------------|
| alignment / soiled lens indicator | flashing light indicator |
| light indicator | LED yellow |
| sensitivity adjustment | potentiometer, 270° |

emitter

| | |
|-------------------|------------------------|
| light source | pulsed red laser diode |
| laser class | 1 |
| distance to focus | parallel beam |
| wave length | 650 nm |

electrical data

| | |
|-----------------------------|---------------|
| voltage supply range +Vs | 11 ... 30 VDC |
| reverse polarity protection | yes |

receiver

| | |
|------------------------------------|----------------------|
| response time / release time | < 0,2 ms |
| current consumption max. (no load) | 16 mA |
| current consumption typ. | 16 mA |
| voltage drop Vd | < 1,8 VDC |
| output function | light / dark operate |
| output current | < 100 mA |
| short circuit protection | yes |

emitter

| | |
|------------------------------------|-------|
| current consumption max. (no load) | 30 mA |
| current consumption typ. | 25 mA |

mechanical data

| | |
|------------------|---------------|
| width / diameter | 10,4 mm |
| height / length | 27 mm |
| type | rectangular |
| housing material | plastic (ASA) |
| front (optics) | PMMA |

receiver

| | |
|-------|-------|
| depth | 14 mm |
|-------|-------|

emitter

| | |
|-------|---------|
| depth | 16,3 mm |
|-------|---------|

ambient conditions

| | |
|-----------------------|----------------|
| operating temperature | -10 ... +50 °C |
|-----------------------|----------------|



connection diagrams

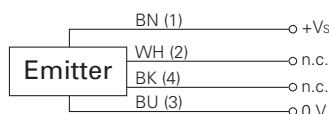

connectors

| | | |
|--------------|-------|--------------|
| ESG 32AH0200 | 4 pin | 2 m straight |
| ESW 31AH0200 | 4 pin | 2 m angular |

additional cable connectors and field wireable connectors, see accessories

accessories

| | |
|-----------------------------------|----------|
| SENSOFIX mounting kit | 10150326 |
| mounting bracket (cable type) | 10114501 |
| mounting bracket (connector type) | 10133792 |

for details, see accessories section

laser warning



Complies with 21 CFR 1040.10 and 1040.11 except for deviations pursuant to laser notice No. 50, dated June 24, 2007

| order reference | emitter / receiver | connection types | output circuit | protection class |
|-------------------|--------------------|--------------------|----------------|------------------|
| OEDK 10N5105 | receiver | cable 4 pin, 2 m | NPN | IP 65 |
| OEDK 10N5105/S35A | receiver | connector M8 4 pin | NPN | IP 67 |
| OEDK 10P5105 | receiver | cable 4 pin, 2 m | PNP | IP 65 |
| OEDK 10P5105/S35A | receiver | connector M8 4 pin | PNP | IP 67 |
| OSDK 10D9005 | emitter | cable 4 pin, 2 m | - | IP 65 |
| OSDK 10D9005/S35A | emitter | connector M8 4 pin | - | IP 67 |

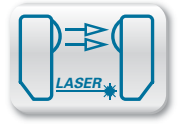

excess gain curve

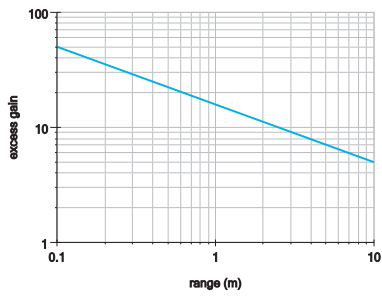

beam characteristic (typically)

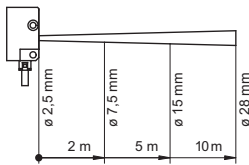

dimension drawings

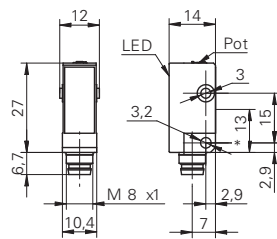

* receiver axis

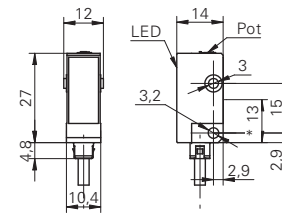

* receiver axis

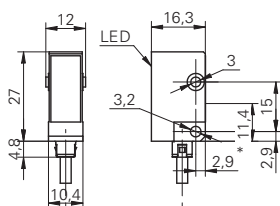

* emitter axis

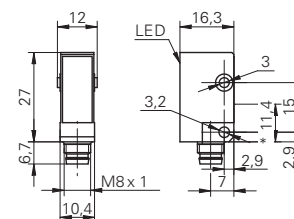

* emitter axis

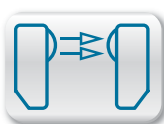

S_b = 6 m

- rugged miniature metal housing
- test input

general data

| | |
|------------------------------|---------------------|
| type | through beam sensor |
| actual range S _b | 6 m |
| nominal range S _n | 7,5 m |

receiver

| | |
|-----------------------------------|--------------------------|
| alignment / soiled lens indicator | flashing light indicator |
| light indicator | LED yellow |
| sensitivity adjustment | no |

emitter

| | |
|--------------|----------------|
| light source | pulsed red LED |
| wave length | 660 nm |

electrical data

| | |
|-----------------------------|---------------|
| voltage supply range +Vs | 10 ... 30 VDC |
| reverse polarity protection | yes |

receiver

| | |
|------------------------------------|----------------------|
| response time / release time | < 1 ms |
| current consumption max. (no load) | 17 mA |
| current consumption typ. | 17 mA |
| voltage drop V _d | < 1,8 VDC |
| output function | light / dark operate |
| output circuit | PNP |
| output current | < 100 mA |
| short circuit protection | yes |

emitter

| | |
|------------------------------------|-------|
| current consumption max. (no load) | 30 mA |
| current consumption typ. | 18 mA |

mechanical data

| | |
|------------------|---------------|
| width / diameter | 12,4 mm |
| height / length | 35 mm |
| depth | 35 mm |
| type | rectangular |
| housing material | die-cast zinc |
| front (optics) | PMMA |

ambient conditions

| | |
|-----------------------|----------------|
| operating temperature | -25 ... +65 °C |
| protection class | IP 67 |

| order reference | emitter / receiver | connection types |
|-------------------|--------------------|--------------------|
| FEDM 12P5101 | receiver | cable 4 pin, 2 m |
| FEDM 12P5101/S35A | receiver | connector M8 4 pin |
| FSDM 12D9601 | emitter | cable 3 pin, 2 m |
| FSDM 12D9601/S35A | emitter | connector M8 4 pin |



connection diagrams

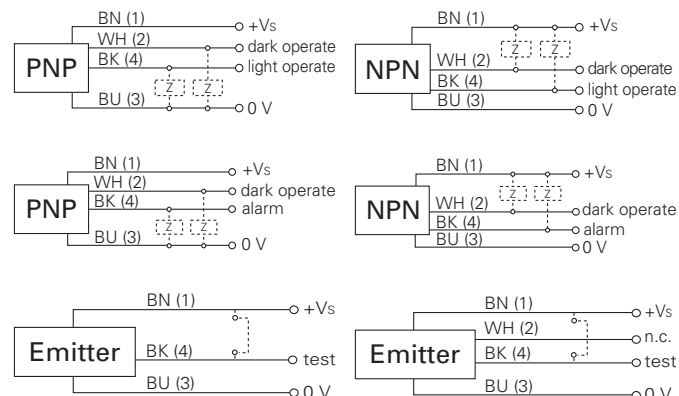

connectors

| | | |
|--------------|-------|--------------|
| ESG 32AH0200 | 4 pin | 2 m straight |
| ESW 31AH0200 | 4 pin | 2 m angular |

additional cable connectors and field wireable connectors, see accessories

accessories

| | |
|-----------------------|----------|
| SENSOFIX mounting kit | 10150328 |
| mounting bracket | 10113873 |

for details, see accessories section

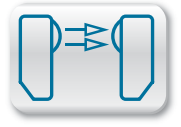

excess gain curve

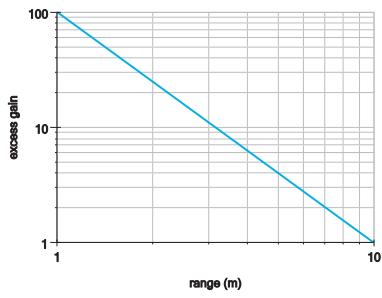

dimension drawings

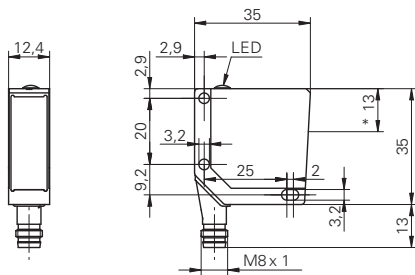

* receiver axis

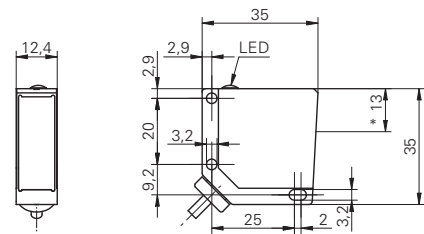

* receiver axis

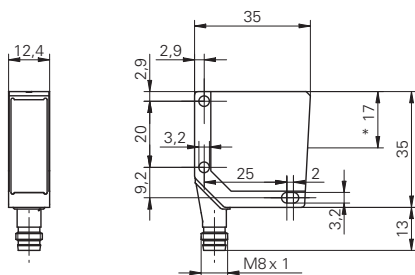

* emitter axis

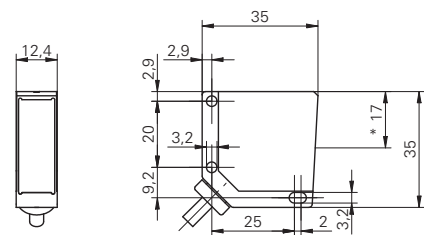

* emitter axis

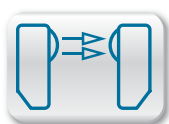

Sb = 12 m

- long range
- test input

general data

| | |
|------------------|---------------------|
| type | through beam sensor |
| actual range Sb | 12 m |
| nominal range Sn | 15 m |

receiver

| | |
|-----------------------------------|--------------------------|
| alignment / soiled lens indicator | flashing light indicator |
| light indicator | LED yellow |
| sensitivity adjustment | no |

emitter

| | |
|--------------|----------------|
| light source | pulsed red LED |
| wave length | 660 nm |

electrical data

| | |
|------------------------------------|---------------|
| voltage supply range +Vs | 10 ... 30 VDC |
| current consumption max. (no load) | 20 mA |
| reverse polarity protection | yes |

receiver

| | |
|------------------------------|----------------------|
| response time / release time | < 1,2 ms |
| current consumption typ. | 20 mA |
| voltage drop Vd | < 1,8 VDC |
| output function | light / dark operate |
| output current | < 100 mA |
| short circuit protection | yes |

emitter

| | |
|--------------------------|-------|
| current consumption typ. | 12 mA |
|--------------------------|-------|

mechanical data

| | |
|------------------|---------------------|
| width / diameter | 14,8 mm |
| height / length | 43 mm |
| depth | 31 mm |
| type | rectangular |
| housing material | plastic (ASA, MABS) |
| front (optics) | PMMA |
| connection types | connector M8 4 pin |

ambient conditions

| | |
|-----------------------|----------------|
| operating temperature | -25 ... +65 °C |
| protection class | IP 67 |

| order reference | emitter / receiver | output circuit |
|-------------------|--------------------|----------------|
| FEDK 14N5101/S35A | receiver | NPN |
| FEDK 14P5101/S35A | receiver | PNP |
| FSDK 14D9601/S35A | emitter | - |

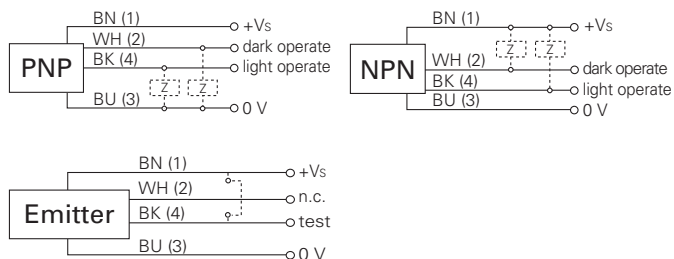
**connection diagrams****connectors**

| | | |
|--------------|-------|--------------|
| ESG 32AH0200 | 4 pin | 2 m straight |
| ESW 31AH0200 | 4 pin | 2 m angular |

additional cable connectors and field wireable connectors, see accessories

accessories

| | |
|------------------------|----------|
| SENSOFIX mounting kit | 10149011 |
| mounting bracket | 10134964 |
| slot aperture stickers | 10144075 |

for details, see accessories section

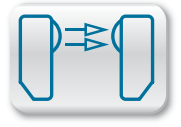

excess gain curve

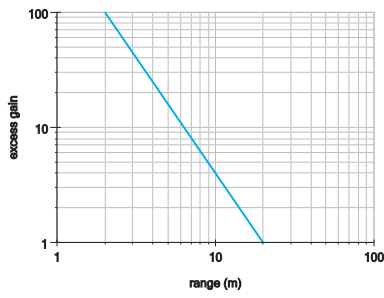

dimension drawings

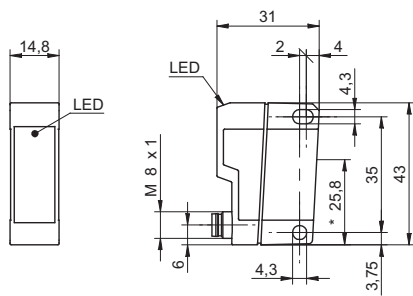

* emitter and receiver axis

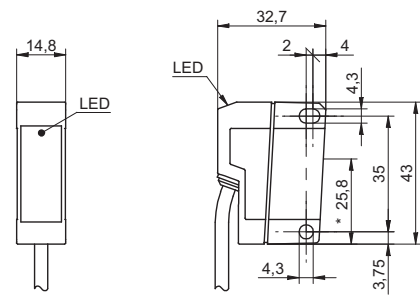

* emitter and receiver axis

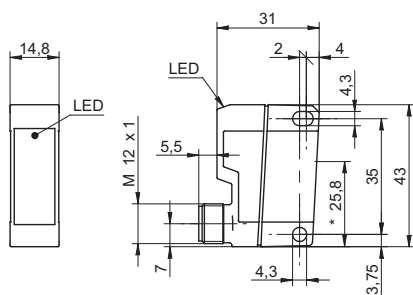

* emitter and receiver axis

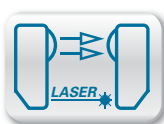

Sb = 8 m

- long range
- short response time

general data

| | |
|------------------|---------------------------|
| type | through beam laser sensor |
| actual range Sb | 8 m |
| nominal range Sn | 10 m |

receiver

| | |
|-----------------------------------|--------------------------|
| alignment / soiled lens indicator | flashing light indicator |
| light indicator | LED yellow |
| sensitivity adjustment | no |

emitter

| | |
|---------------------|------------------------|
| light source | pulsed red laser diode |
| power on indication | LED green |
| laser class | 1 |
| distance to focus | parallel beam |
| wave length | 650 nm |

electrical data

| | |
|-----------------------------|---------------|
| voltage supply range +Vs | 10 ... 30 VDC |
| reverse polarity protection | yes |

receiver

| | |
|------------------------------------|----------------------|
| response time / release time | < 0,5 ms |
| current consumption max. (no load) | 20 mA |
| current consumption typ. | 20 mA |
| voltage drop Vd | < 1,8 VDC |
| output function | light / dark operate |
| output circuit | PNP |
| output current | < 100 mA |
| short circuit protection | yes |

emitter

| | |
|------------------------------------|-------|
| current consumption max. (no load) | 35 mA |
| current consumption typ. | 25 mA |

mechanical data

| | |
|------------------|---------------------|
| width / diameter | 14,8 mm |
| height / length | 43 mm |
| depth | 31 mm |
| type | rectangular |
| housing material | plastic (ASA, MABS) |
| front (optics) | PMMA |
| connection types | connector M8 4 pin |

ambient conditions

| | |
|------------------|-------|
| protection class | IP 67 |
|------------------|-------|

receiver

| | |
|-----------------------|----------------|
| operating temperature | -25 ... +65 °C |
|-----------------------|----------------|

emitter

| | |
|-----------------------|---------------|
| operating temperature | 10 ... +50 °C |
|-----------------------|---------------|

order reference**emitter / receiver**

| | |
|-------------------|----------|
| OEDK 14P5101/S35A | receiver |
| OSDK 14D9001/S35A | emitter |

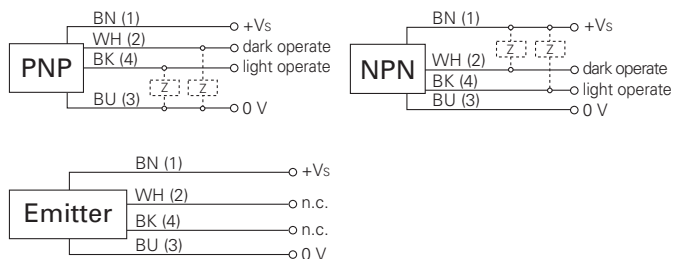
**connection diagrams****connectors**

| | | |
|--------------|-------|--------------|
| ESG 32AH0200 | 4 pin | 2 m straight |
| ESW 31AH0200 | 4 pin | 2 m angular |

additional cable connectors and field wireable connectors, see accessories

accessories

| | |
|-----------------------|----------|
| SENSOFIX mounting kit | 10149011 |
| mounting bracket | 10134964 |

for details, see accessories section

laser warning

**CLASS 1 LASER
PRODUCT**

Complies with 21 CFR 1040.10 and 1040.11
except for deviations pursuant to laser
notice No. 50, dated June 24, 2007

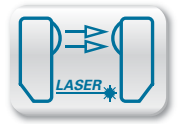

excess gain curve

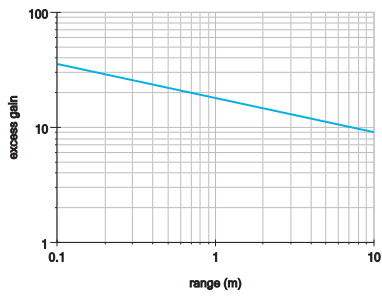

beam characteristic (typically)

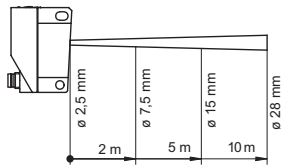

dimension drawings

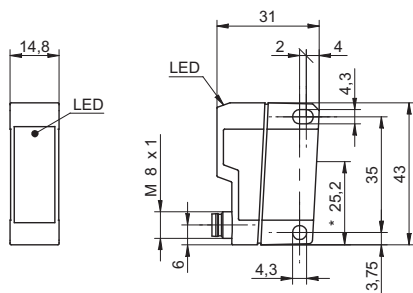

* emitter and receiver axis

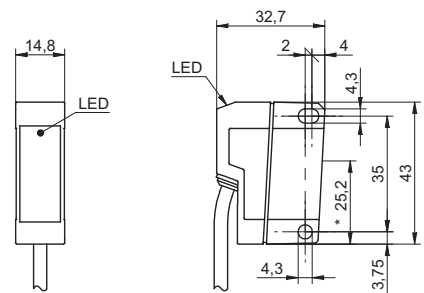

* emitter and receiver axis

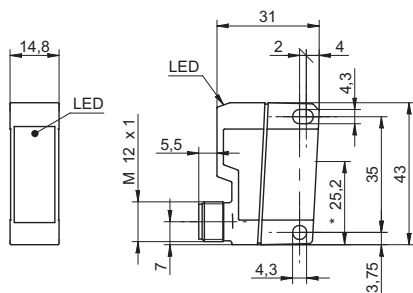

* emitter and receiver axis

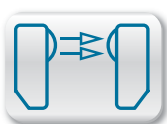

Sb = 8 m

- rugged metal housing
- sensing range adjustable via potentiometer

general data

type through beam sensor

receiver

alignment / soiled lens indicator flashing light indicator

light indicator LED yellow

emitter

light source pulsed red LED

wave length 660 nm

electrical data

voltage supply range +Vs 10 ... 30 VDC

reverse polarity protection yes

receiver

response time / release time < 1 ms

current consumption max. (no load) 17 mA

current consumption typ. 17 mA

voltage drop Vd < 1,8 VDC

output function light / dark operate

output circuit PNP

output current < 200 mA

short circuit protection yes

emitter

current consumption max. (no load) 30 mA

current consumption typ. 18 mA

test input disable emitter: +Vs
enable emitter: 0 V**mechanical data**

width / diameter 15,4 mm

height / length 50 mm

depth 50 mm

type rectangular

housing material die-cast zinc

front (optics) PMMA

ambient conditions

operating temperature -25 ... +65 °C

protection class IP 67

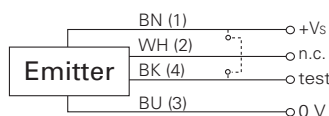
**connection diagrams****connectors**

ESG 34AH0200 4 pin 2 m straight

ESW 33AH0200 4 pin 2 m angular

additional cable connectors and field wireable connectors, see accessories

accessories

SENSOFIX mounting kit 10151721

mounting bracket 10113917

lens cleaning air nozzle bracket 10116407

for details, see accessories section

| order reference | emitter / receiver | nominal range Sn | actual range Sb | connection types | sensitivity adjustment |
|------------------|--------------------|------------------|-----------------|---------------------|------------------------|
| FEDM 16P5101 | receiver | 10 m | 8 m | cable 4 pin, 2 m | no |
| FEDM 16P5101/S14 | receiver | 10 m | 8 m | connector M12 4 pin | no |
| FEDM 16P5105 | receiver | 3,5 m | 3 m | cable 4 pin, 2 m | potentiometer, 10 turn |
| FEDM 16P5105/S14 | receiver | 3,5 m | 3 m | connector M12 4 pin | potentiometer, 10 turn |
| FSDM 16D9601 | emitter | 10 m | 8 m | cable 3 pin, 2 m | - |
| FSDM 16D9601/S14 | emitter | 10 m | 8 m | connector M12 4 pin | - |

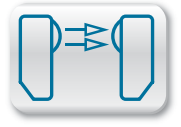

excess gain curves

Sb = 8 m

Sb = 3 m

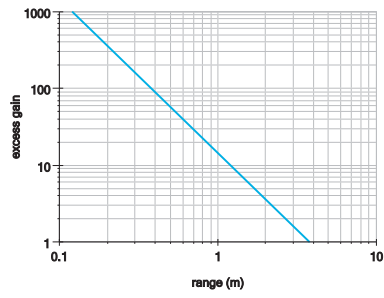
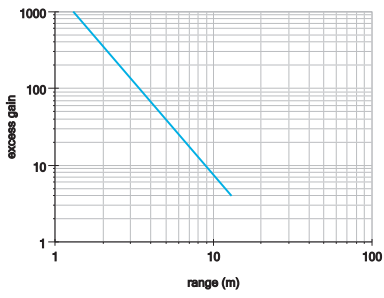

dimension drawings

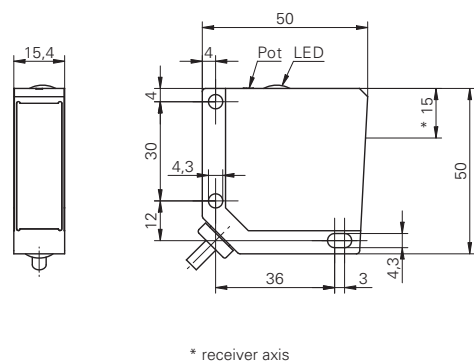
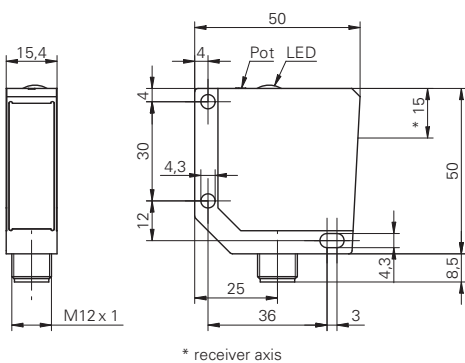
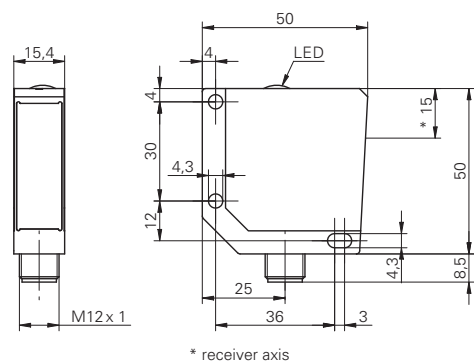
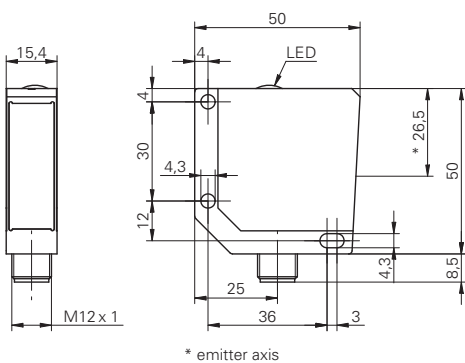

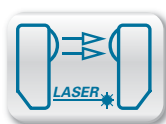

S_b = 8 m

- long range
- short response time

general data

| | |
|-----------------------------------|---------------------------|
| type | through beam laser sensor |
| actual range S _b | 8 m |
| receiver | |
| nominal range S _n | 10 m |
| alignment / soiled lens indicator | LED green |
| output indicator | LED yellow |
| sensitivity adjustment | potentiometer, 270° |
| emitter | |
| light source | pulsed red laser diode |
| repeat accuracy | < 0,4 mm at laser focus |
| laser class | 1 |
| distance to focus | 400 mm |
| wave length | 675 nm |

electrical data

| | |
|-----------------------------|---------------|
| voltage supply range +Vs | 10 ... 30 VDC |
| reverse polarity protection | yes |

receiver

| | |
|------------------------------------|----------|
| response time / release time | < 0,1 ms |
| current consumption max. (no load) | 30 mA |
| current consumption typ. | 30 mA |
| voltage drop V _d | < 2 VDC |
| output circuit | PNP |
| output current | < 200 mA |
| short circuit protection | yes |

emitter

| | |
|------------------------------------|-------|
| current consumption max. (no load) | 75 mA |
| current consumption typ. | 60 mA |

mechanical data

| | |
|------------------|---------------|
| width / diameter | 15,4 mm |
| height / length | 50 mm |
| depth | 50 mm |
| type | rectangular |
| housing material | die-cast zinc |
| front (optics) | glass |

ambient conditions

| | |
|------------------|-------|
| protection class | IP 67 |
|------------------|-------|

receiver

| | |
|-----------------------|----------------|
| operating temperature | -25 ... +65 °C |
|-----------------------|----------------|

emitter

| | |
|-----------------------|---------------|
| operating temperature | 10 ... +50 °C |
|-----------------------|---------------|

| order reference | emitter / receiver | connection types | output function |
|------------------|--------------------|---------------------|----------------------|
| OEDM 16P3401 | receiver | cable 4 pin, 2 m | alarm output dark |
| OEDM 16P3401/S14 | receiver | connector M12 4 pin | alarm output dark |
| OEDM 16P5101 | receiver | cable 4 pin, 2 m | light / dark operate |
| OEDM 16P5101/S14 | receiver | connector M12 4 pin | light / dark operate |
| OSDM 16D9601 | emitter | cable 3 pin, 2 m | - |
| OSDM 16D9601/S14 | emitter | connector M12 4 pin | - |



connection diagrams

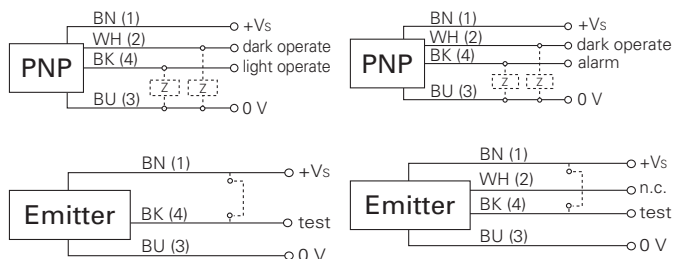

connectors

| | | |
|--------------|-------|--------------|
| ESG 34AH0200 | 4 pin | 2 m straight |
| ESW 33AH0200 | 4 pin | 2 m angular |

additional cable connectors and field wireable connectors, see accessories

accessories

| | |
|----------------------------------|----------|
| SENSOFIX mounting kit | 10151721 |
| mounting bracket emitter | 10119373 |
| mounting bracket receiver | 10113917 |
| lens cleaning air nozzle bracket | 10116407 |

for details, see accessories section

laser warning



Complies with 21 CFR 1040.10 and 1040.11 except for deviations pursuant to laser notice No. 50, dated June 24, 2007

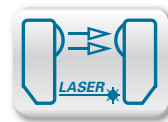

excess gain curve

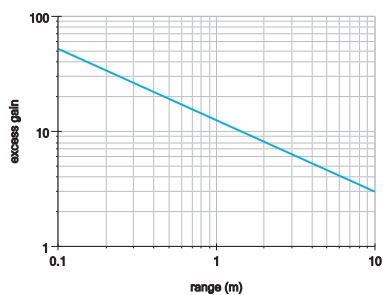

beam characteristic (typically)

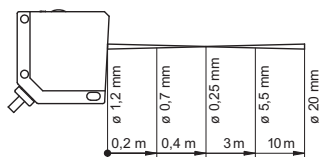

dimension drawings

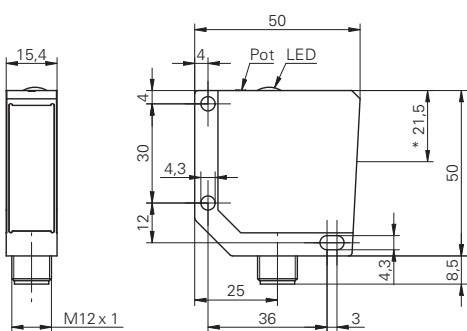

* receiver axis

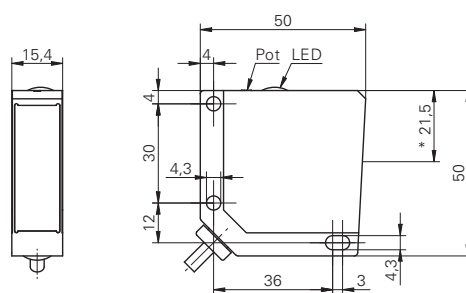

* receiver axis

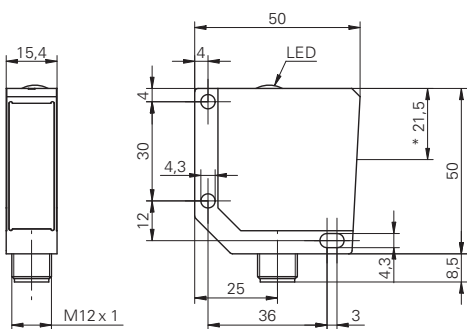

* emitter axis

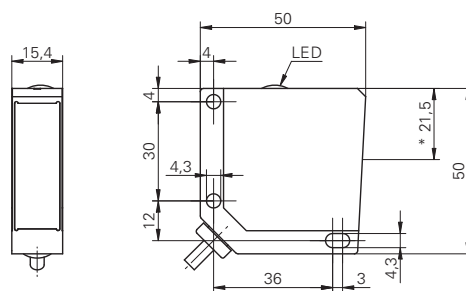

* emitter axis

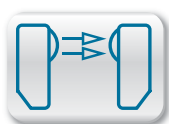

Sb = 16 m

- subminiature metal housing
- cylindrical design

general data

| | |
|------------------|---------------------|
| type | through beam sensor |
| actual range Sb | 16 m |
| nominal range Sn | 20 m |

receiver

| | |
|-----------------------------------|--------------------------|
| alignment / soiled lens indicator | flashing light indicator |
| light indicator | LED yellow |
| sensitivity adjustment | potentiometer, 270° |

emitter

| | |
|--------------|-----------------------|
| light source | pulsed infrared diode |
| wave length | 880 nm |

electrical data

| | |
|-----------------------------|---------------|
| voltage supply range +Vs | 10 ... 30 VDC |
| reverse polarity protection | yes |

receiver

| | |
|------------------------------------|--------------|
| response time / release time | < 1 ms |
| current consumption max. (no load) | 20 mA |
| current consumption typ. | 20 mA |
| voltage drop Vd | < 1,8 VDC |
| output function | dark operate |
| output current | < 200 mA |
| short circuit protection | yes |

emitter

| | |
|------------------------------------|-------|
| current consumption max. (no load) | 40 mA |
| current consumption typ. | 30 mA |

mechanical data

| | |
|------------------|--------------------------|
| width / diameter | 18 mm |
| type | cylindrical |
| housing material | brass nickel plated / PC |
| front (optics) | PC |

ambient conditions

| | |
|-----------------------|----------------|
| operating temperature | -25 ... +55 °C |
| protection class | IP 67 |



connection diagrams

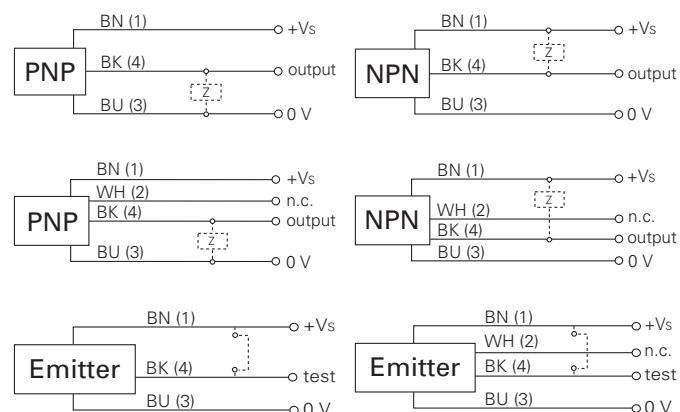

connectors

| | | |
|--------------|-------|--------------|
| ESG 34AH0200 | 4 pin | 2 m straight |
| ESW 33AH0200 | 4 pin | 2 m angular |

additional cable connectors and field wireable connectors, see accessories

accessories

| | |
|-----------------------|----------|
| SENSOFIX mounting kit | 10151658 |
| glass cover | 10103068 |
| cap nut | 10101480 |

for details, see accessories section

| order reference | emitter / receiver | connection types | height / length | output circuit |
|------------------|--------------------|---------------------|-----------------|----------------|
| FEAM 18N3150 | receiver | cable 3 pin, 2 m | 57 mm | NPN |
| FEAM 18N3150/S14 | receiver | connector M12 4 pin | 67 mm | NPN |
| FEAM 18P3150 | receiver | cable 3 pin, 2 m | 57 mm | PNP |
| FEAM 18P3150/S14 | receiver | connector M12 4 pin | 67 mm | PNP |
| FSAM 18D9651 | emitter | cable 3 pin, 2 m | 57 mm | - |
| FSAM 18D9651/S14 | emitter | connector M12 4 pin | 67 mm | - |

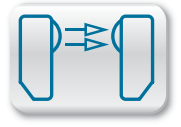

excess gain curve

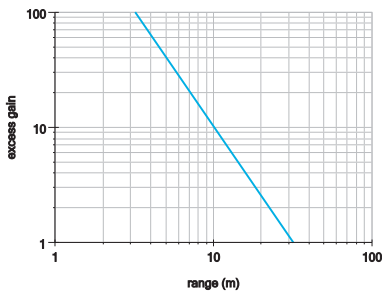

dimension drawings

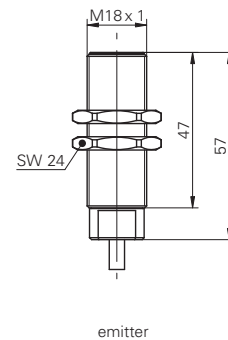
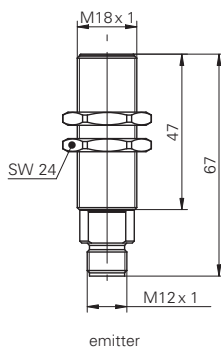
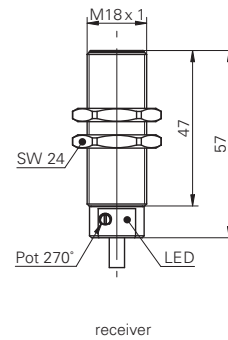
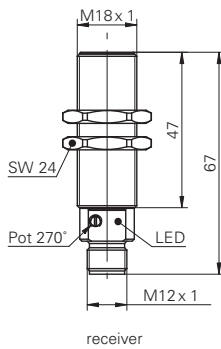

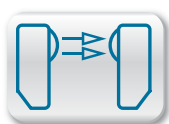

Sb = 6 m

- cross-technology housing concept
- small mounting depth
- test input

general data

| | |
|------------------|---------------------|
| type | through beam sensor |
| actual range Sb | 6 m |
| nominal range Sn | 8 m |

receiver

| | |
|-----------------------------------|--------------------------|
| alignment / soiled lens indicator | flashing light indicator |
| light indicator | LED yellow |
| sensitivity adjustment | potentiometer, 270° |

emitter

| | |
|--------------|----------------|
| light source | pulsed red LED |
| wave length | 660 nm |

electrical data

| | |
|-----------------------------|---------------|
| voltage supply range +Vs | 10 ... 30 VDC |
| reverse polarity protection | yes |

receiver

| | |
|------------------------------------|----------------------|
| response time / release time | < 0,5 ms |
| current consumption max. (no load) | 20 mA |
| current consumption typ. | 20 mA |
| voltage drop Vd | < 1,8 VDC |
| output function | light / dark operate |
| output current | < 100 mA |
| short circuit protection | yes |

emitter

| | |
|------------------------------------|-------|
| current consumption max. (no load) | 25 mA |
| current consumption typ. | 22 mA |

mechanical data

| | |
|------------------|--------------------|
| width / diameter | 20 mm |
| height / length | 42 mm |
| depth | 15 mm |
| type | rectangular |
| housing material | plastic (PBT-ASA) |
| front (optics) | PMMA |
| connection types | connector M8 4 pin |

ambient conditions

| | |
|-----------------------|----------------|
| operating temperature | -25 ... +65 °C |
| protection class | IP 67 |

| order reference | emitter / receiver | output circuit |
|-------------------|--------------------|----------------|
| FEDK 20N5101/S35A | receiver | NPN |
| FEDK 20P5101/S35A | receiver | PNP |
| FSDK 20D9601/S35A | emitter | - |

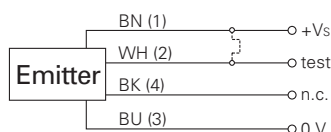
**connection diagrams****connectors**

| | | |
|--------------|-------|--------------|
| ESG 32AH0200 | 4 pin | 2 m straight |
| ESW 31AH0200 | 4 pin | 2 m angular |

additional cable connectors and field wireable connectors, see accessories

accessories

| | |
|-----------------------|----------|
| SENSOFIX mounting kit | 10150326 |
|-----------------------|----------|

for details, see accessories section

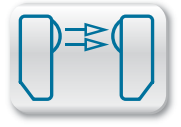

excess gain curve

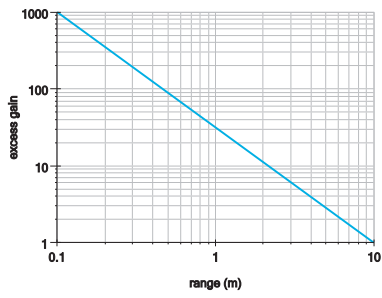

dimension drawings

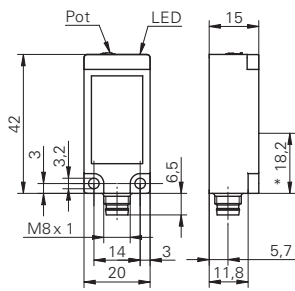



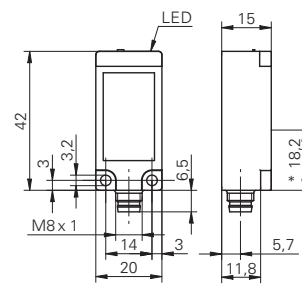



* receiver axis











* emitter axis

red light LED version

| product family | FGUM 030 | FGUM 050 | FGUM 080 | FGUM 020 | FGUM 030 | FGUM 050 | FGUM 080 |
|------------------------------|---|---|---|--|---|---|---|
| |  |  |  |  |  |  |  |
| width / diameter | 50 mm | 70 mm | 100 mm | 40 mm | 50 mm | 70 mm | 100 mm |
| fork width Sb | 30 mm | 50 mm | 80 mm | 20 mm | 30 mm | 50 mm | 80 mm |
| response time / release time | < 0,166 ms | < 0,166 ms | < 0,166 ms | < 0,125 ms | < 0,125 ms | < 0,125 ms | < 0,125 ms |
| sensitivity adjustment | Teach-in: button / remote | Teach-in: button / remote | Teach-in: button / remote | potentiometer, 270° | potentiometer, 270° | potentiometer, 270° | potentiometer, 270° |
| PNP | ■ | ■ | ■ | ■ | ■ | ■ | ■ |
| cable | | | | | | | |
| connector | ■ | ■ | ■ | ■ | ■ | ■ | ■ |
| housing material | metal | metal | metal | metal | metal | metal | metal |
| | | | | | | | |
| page | 287 | 288 | 289 | 290 | 291 | 292 | 293 |

laser version

| product family | OGUM 030 | OGUM 050 | OGUM 080 | OGUM 120 |
|------------------------------|---|---|---|--|
| |  |  |  |  |
| width / diameter | 60 mm | 80 mm | 110 mm | 150 mm |
| fork width Sb | 30 mm | 50 mm | 80 mm | 120 mm |
| response time / release time | < 0,166 ms | < 0,166 ms | < 0,166 ms | < 0,166 ms |
| sensitivity adjustment | potentiometer, 270° | potentiometer, 270° | potentiometer, 270° | potentiometer, 270° |
| PNP | ■ | ■ | ■ | ■ |
| connector | ■ | ■ | ■ | ■ |
| housing material | metal | metal | metal | metal |
| | | | | |
| page | 295 | 296 | 297 | 298 |

| FGUM 120 | FGLM 050 | FGLM 080 | FGLM 120 |
|---|---|---|---|
|  |  |  |  |
| 144 mm | 75 mm | 105 mm | 150 mm |
| 120 mm | 60 mm | 100 mm | 158 mm |
| < 0,25 ms | < 0,125 ms | < 0,125 ms | < 0,25 ms |
| potentiometer, 270° | potentiometer, 270° | potentiometer, 270° | potentiometer, 270° |
| ■ | ■ | ■ | ■ |
| ■ | ■ | ■ | ■ |
| metal | metal | metal | metal |
| | | | |
| 294 | 299 | 300 | 301 |



Introduction

Fork and angle sensors comprise an emitter and a receiver optimally aligned to one another and installed in a torsionally rigid metal housing. This enables highly accurate scanning and positioning of objects, as is required in automatic feeders, vibration conveyors and other applications, while high repeatability is ensured by precise collimator optics. Equipped with a laser light source, fork sensors can even position the very smallest of parts in the micron range. Time-consuming alignment and adjustment usually required for through beam sensors is unnecessary. Compared to through beam sensors, the electric wiring features just one cable connection.

Typical applications

Thanks to their simple handling and optimally aligned optics, fork and angle sensors are extremely versatile. To enable optimum installation, different fork widths as well as U- and L-shaped versions are available.

Scanning and positioning

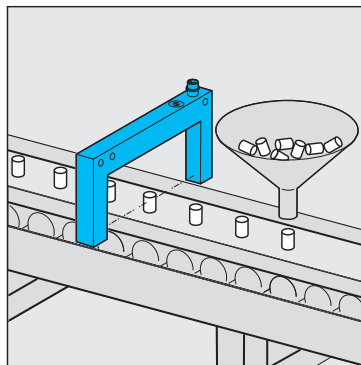

Scanning very small objects down to $50\ \mu\text{m}$ in an automatic feeder

Stack height monitoring

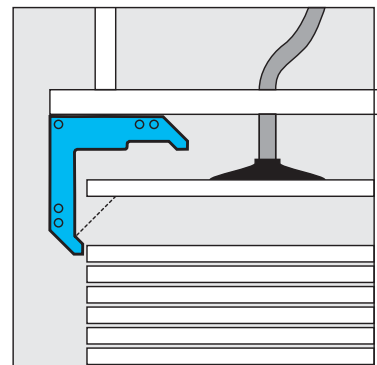

Monitoring cardboard sheet stack heights

Rotational speed monitoring

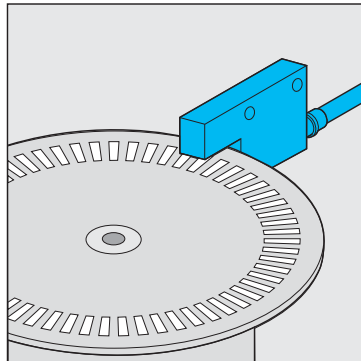

Rotational speed monitoring of shafts using pulse disks



Features and benefits

Easy installation and adjustment

The emitter and receiver are already optimally aligned to one another in a torsionally rigid metal housing.

Innovative shapes

The special L-shape of the angle sensor enables optimum approach towards the optical axis.

Fast processes

Switching frequencies of up to 50 kHz allow rotational speed measurements.

Rugged

Use possible even in harsh ambient conditions thanks to metal housing and protection class IP 67.

Technology and function

Fork and angle sensors as well as through beam sensors are founded on the same basic principle.

The scratch-resistant, mineral glass collimator optics used in the fork and angle sensors FGUM/FGLM and OGUM produces a homogeneous, very narrow light beam. This feature gives the sensor its high detection accuracy, which is guaranteed over the entire beam range from all sides.

The largest laser fork sensor can reliably and repeatedly detect a 50 µm object over the entire 120 mm range.

The virtually parallel light beam and the small beam angle of the receiver optics make it possible to install the fork and angle sensors side by side without affecting each other and even produce, for example, small light barriers.

Sensitivity adjustment features a choice of two different adjustment methods – easy manual adjustment of sensitivity using a potentiometer or variable adjustment options by automatic teach-in.

Potentiometer

Easy sensitivity adjustment thanks to mechanical 270° potentiometer directly on the fork sensor.

Teach-in

The teach-in function enables rapid and easy commissioning in the field. The teach-in operation can be performed using the integrated teach-in button or the external teach-in cable.



Mounting and adjustment

The almost parallel light beam and the small beam angle of the receiver optics make it possible to install the sensors side by side without affecting each other and even construct, for example, small light barriers.

Attach the fork and angle sensors so that the object can pass freely through the scanning range. The receiver side should be protected from direct exposure to external light sources.

Potentiometer adjustment

Sensitivity is highest when the potentiometer is turned fully counterclockwise, enabling the smallest possible parts to be scanned with minimal power of the beam.

When the potentiometer is turned fully clockwise, sensitivity is lowest, so only larger parts are scanned. The power of the beam is highest and the fork/angle sensor has high excess gain to combat dirt.

Teach-in adjustment

The dynamic teach-in facility enables the sensor to calculate the optimum sensitivity level during operation, resulting in new potential applications.

For example, the smallest objects can be taught in without precise positioning simply by passing the light beam.

To initiate the dynamic teach-in procedure, the yellow teach-in button must be held down for 2 seconds. At least two objects should pass the light beam of the fork sensor during the following 2-4 seconds of the active teach-in phase. The LED indicates the active teach-in phase by flashing rapidly. If the teach-in procedure was completed successfully, this is clearly and visibly indicated by two flashes of the LED.

The active teach-in phase can be defined individually using an external teach-in facility. The longer a pulse is applied to the external teach-in cable, the longer the sensor teaches in its surrounding. When the external teach-in facility is employed, the teach-in button can also be automatically disabled.

Adjustment of light/dark switching

The output functions NO (dark-switching) and NC (light-switching) can be adjusted using a rotary switch. The required switch position is indicated on the type plate. To prevent accidental switching, the rotary switch is covered by a rubber cap.

Important: always set the switch for the output function fully clockwise or counterclockwise. Intermediate positions lead to undefined output states.

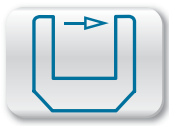

Sb = 30 mm

- sensitivity adjustable via Teach-in
- smallest detectable object 0,3 mm
- rugged metal housing



general data

| | |
|------------------------|---------------------------|
| type | through beam sensor |
| object size | > 0,3 mm |
| repeat accuracy | < 0,03 mm |
| hysteresis | < 0,1 mm |
| ambient light immunity | < 20 kLux |
| sensitivity adjustment | Teach-in: button / remote |
| light source | pulsed red LED |
| wave length | 660 nm |
| light indicator | LED yellow |

electrical data

| | |
|------------------------------------|---------------------------------|
| response time / release time | < 0,166 ms |
| switching frequency | < 3 kHz |
| voltage supply range +Vs | 10 ... 35 VDC |
| current consumption max. (no load) | 30 mA |
| output function | light / dark operate switchable |
| output circuit | PNP |
| voltage drop Vd | < 2 VDC |
| output current | < 200 mA |
| short circuit protection | yes |
| reverse polarity protection | yes |

mechanical data

| | |
|-------------------|---------------|
| width / diameter | 50 mm |
| fork width Sb | 30 mm |
| height / length | 60 mm |
| penetration depth | 35 mm |
| depth | 10 mm |
| type | U profile |
| housing material | die-cast zinc |
| connection types | connector M8 |

ambient conditions

| | |
|-----------------------|----------------|
| operating temperature | -10 ... +60 °C |
| protection class | IP 67 |

connectors

| | | |
|--------------|-------|--------------|
| ESG 32AH0200 | 4 pin | 2 m straight |
| ESW 31AH0200 | 4 pin | 2 m angular |

additional cable connectors and field wireable connectors, see accessories

order reference

FGUM 030P6901/S35A

dimension drawing

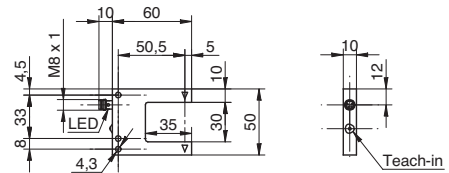

connection diagram

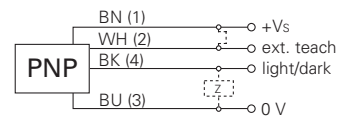

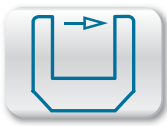

Sb = 50 mm



- sensitivity adjustable via Teach-in
- smallest detectable object 0,3 mm
- rugged metal housing

general data

| | |
|------------------------|---------------------------|
| type | through beam sensor |
| object size | > 0,3 mm |
| repeat accuracy | < 0,03 mm |
| hysteresis | < 0,1 mm |
| ambient light immunity | < 20 kLux |
| sensitivity adjustment | Teach-in: button / remote |
| light source | pulsed red LED |
| wave length | 660 nm |
| light indicator | LED yellow |

electrical data

| | |
|------------------------------------|---------------------------------|
| response time / release time | < 0,166 ms |
| switching frequency | < 3 kHz |
| voltage supply range +Vs | 10 ... 35 VDC |
| current consumption max. (no load) | 30 mA |
| output function | light / dark operate switchable |
| output circuit | PNP |
| voltage drop Vd | < 2 VDC |
| output current | < 200 mA |
| short circuit protection | yes |
| reverse polarity protection | yes |

mechanical data

| | |
|-------------------|---------------|
| width / diameter | 70 mm |
| fork width Sb | 50 mm |
| height / length | 80 mm |
| penetration depth | 55 mm |
| depth | 10 mm |
| type | U profile |
| housing material | die-cast zinc |
| connection types | connector M8 |

ambient conditions

| | |
|-----------------------|----------------|
| operating temperature | -10 ... +60 °C |
| protection class | IP 67 |

connectors

| | | |
|--------------|-------|--------------|
| ESG 32AH0200 | 4 pin | 2 m straight |
| ESW 31AH0200 | 4 pin | 2 m angular |

additional cable connectors and field wireable connectors, see accessories

order reference

FGUM 050P6901/S35A

dimension drawing

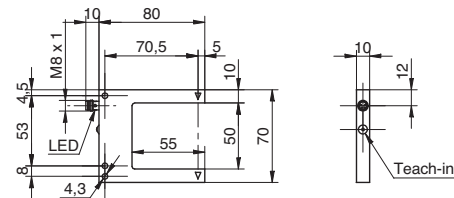

connection diagram

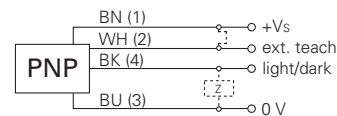

FGUM 050 Sb = 50 mm

Fork and angle sensors

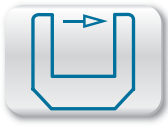

Sb = 80 mm

- sensitivity adjustable via Teach-in
- smallest detectable object 0,3 mm
- rugged metal housing



general data

| | |
|------------------------|---------------------------|
| type | through beam sensor |
| object size | > 0,3 mm |
| repeat accuracy | < 0,03 mm |
| hysteresis | < 0,1 mm |
| ambient light immunity | < 20 kLux |
| sensitivity adjustment | Teach-in: button / remote |
| light source | pulsed red LED |
| wave length | 660 nm |
| light indicator | LED yellow |

dimension drawing

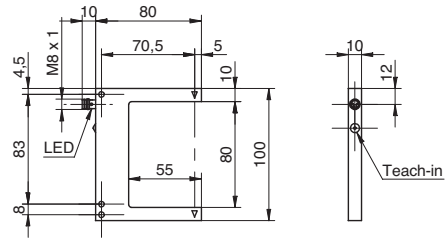

electrical data

| | |
|------------------------------------|---------------------------------|
| response time / release time | < 0,166 ms |
| switching frequency | < 3 kHz |
| voltage supply range +Vs | 10 ... 35 VDC |
| current consumption max. (no load) | 30 mA |
| output function | light / dark operate switchable |
| output circuit | PNP |
| voltage drop Vd | < 2 VDC |
| output current | < 200 mA |
| short circuit protection | yes |
| reverse polarity protection | yes |

connection diagram

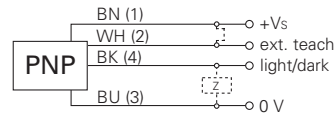

mechanical data

| | |
|-------------------|---------------|
| width / diameter | 100 mm |
| fork width Sb | 80 mm |
| height / length | 80 mm |
| penetration depth | 55 mm |
| depth | 10 mm |
| type | U profile |
| housing material | die-cast zinc |
| connection types | connector M8 |

ambient conditions

| | |
|-----------------------|----------------|
| operating temperature | -10 ... +60 °C |
| protection class | IP 67 |

connectors

| | | |
|--------------|-------|--------------|
| ESG 32AH0200 | 4 pin | 2 m straight |
| ESW 31AH0200 | 4 pin | 2 m angular |

additional cable connectors and field wireable connectors, see accessories

order reference

FGUM 080P6901/S35A

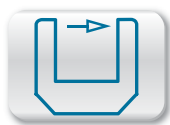

Sb = 20 mm

- sensitivity adjustable via potentiometer
- fork width 20 mm
- rugged metal housing

general data

| | |
|------------------------|---------------------|
| type | through beam sensor |
| object size | > 0,4 mm |
| repeat accuracy | < 0,02 mm |
| hysteresis | < 0,1 mm |
| ambient light immunity | < 50 kLux |
| sensitivity adjustment | potentiometer, 270° |
| light source | pulsed red LED |
| wave length | 660 nm |
| light indicator | LED yellow |

electrical data

| | |
|------------------------------------|---------------------------------|
| response time / release time | < 0,125 ms |
| switching frequency | < 4 kHz |
| voltage supply range +Vs | 10 ... 35 VDC |
| current consumption max. (no load) | 30 mA |
| output function | light / dark operate switchable |
| output circuit | PNP |
| voltage drop Vd | < 2,8 VDC |
| output current | < 200 mA |
| short circuit protection | yes |
| reverse polarity protection | yes |

mechanical data

| | |
|-------------------|---------------------|
| width / diameter | 40 mm |
| fork width Sb | 20 mm |
| height / length | 50 mm |
| penetration depth | 25 mm |
| depth | 10 mm |
| type | U profile |
| housing material | die-cast zinc |
| connection types | connector M8, 3 pin |

ambient conditions

| | |
|-----------------------|----------------|
| operating temperature | -10 ... +60 °C |
| protection class | IP 67 |

connectors

| | | |
|--------------|-------|--------------|
| ESG 32SH0200 | 3 pin | 2 m straight |
| ESW 31SH0200 | 3 pin | 2 m angular |

additional cable connectors and field wireable connectors, see accessories

accessories

| | |
|----------------------|----------|
| PNP to NPN-converter | 10149587 |
|----------------------|----------|

for details, see accessories section

order reference

FGUM 020P8001/S35L



dimension drawing

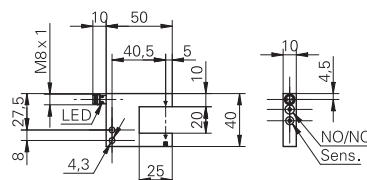

connection diagram

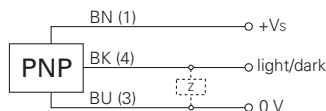

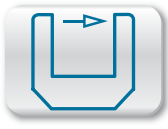

Sb = 30 mm

- sensitivity adjustable via potentiometer
- fork width 30 mm
- rugged metal housing



general data

| | |
|------------------------|---------------------|
| type | through beam sensor |
| object size | > 0,5 mm |
| repeat accuracy | < 0,02 mm |
| hysteresis | < 0,25 mm |
| ambient light immunity | < 140 kLux |
| sensitivity adjustment | potentiometer, 270° |
| light source | pulsed red LED |
| wave length | 660 nm |
| light indicator | LED yellow |

electrical data

| | |
|------------------------------------|---------------------------------|
| response time / release time | < 0,125 ms |
| switching frequency | < 4 kHz |
| voltage supply range +Vs | 10 ... 35 VDC |
| current consumption max. (no load) | 30 mA |
| output function | light / dark operate switchable |
| output circuit | PNP |
| voltage drop Vd | < 2,8 VDC |
| output current | < 200 mA |
| short circuit protection | yes |
| reverse polarity protection | yes |

mechanical data

| | |
|-------------------|---------------------|
| width / diameter | 50 mm |
| fork width Sb | 30 mm |
| height / length | 60 mm |
| penetration depth | 35 mm |
| depth | 10 mm |
| type | U profile |
| housing material | die-cast zinc |
| connection types | connector M8, 3 pin |

ambient conditions

| | |
|-----------------------|----------------|
| operating temperature | -10 ... +60 °C |
| protection class | IP 67 |

connectors

| | | |
|--------------|-------|--------------|
| ESG 32SH0200 | 3 pin | 2 m straight |
| ESW 31SH0200 | 3 pin | 2 m angular |

additional cable connectors and field wireable connectors, see accessories

accessories

| | |
|--------------------------------------|----------|
| PNP to NPN-converter | 10149587 |
| for details, see accessories section | |

order reference

FGUM 030P8001/S35L

dimension drawing

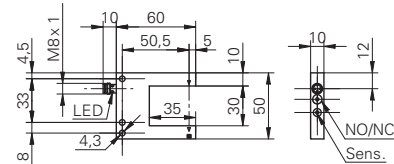

connection diagram

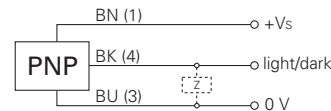

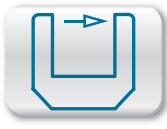

Sb = 50 mm



- sensitivity adjustable via potentiometer
- fork width 50 mm
- rugged metal housing

general data

| | |
|------------------------|---------------------|
| type | through beam sensor |
| object size | > 0,5 mm |
| repeat accuracy | < 0,04 mm |
| hysteresis | < 0,25 mm |
| ambient light immunity | < 80 kLux |
| sensitivity adjustment | potentiometer, 270° |
| light source | pulsed red LED |
| wave length | 660 nm |
| light indicator | LED yellow |

electrical data

| | |
|------------------------------------|---------------------------------|
| response time / release time | < 0,125 ms |
| switching frequency | < 4 kHz |
| voltage supply range +Vs | 10 ... 35 VDC |
| current consumption max. (no load) | 30 mA |
| output function | light / dark operate switchable |
| output circuit | PNP |
| voltage drop Vd | < 2,8 VDC |
| output current | < 200 mA |
| short circuit protection | yes |
| reverse polarity protection | yes |

mechanical data

| | |
|-------------------|---------------------|
| width / diameter | 70 mm |
| fork width Sb | 50 mm |
| height / length | 80 mm |
| penetration depth | 55 mm |
| depth | 10 mm |
| type | U profile |
| housing material | die-cast zinc |
| connection types | connector M8, 3 pin |

ambient conditions

| | |
|-----------------------|----------------|
| operating temperature | -10 ... +60 °C |
| protection class | IP 67 |

connectors

| | | |
|--------------|-------|--------------|
| ESG 32SH0200 | 3 pin | 2 m straight |
| ESW 31SH0200 | 3 pin | 2 m angular |

additional cable connectors and field wireable connectors, see accessories

accessories

| | |
|----------------------|----------|
| PNP to NPN-converter | 10149587 |
|----------------------|----------|

for details, see accessories section

order reference

FGUM 050P8001/S35L

dimension drawing

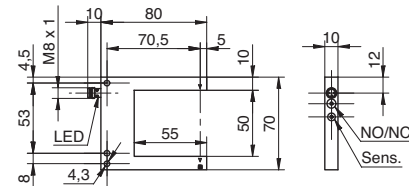

connection diagram

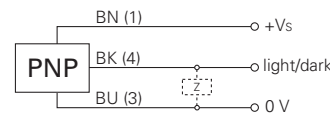

FGUM 050 Sb = 50 mm

Fork and angle sensors

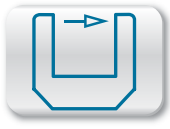

Sb = 80 mm

- sensitivity adjustable via potentiometer
- fork width 80 mm
- rugged metal housing



general data

| | |
|------------------------|---------------------|
| type | through beam sensor |
| object size | > 0,5 mm |
| repeat accuracy | < 0,06 mm |
| hysteresis | < 0,25 mm |
| ambient light immunity | < 80 kLux |
| sensitivity adjustment | potentiometer, 270° |
| light source | pulsed red LED |
| wave length | 660 nm |
| light indicator | LED yellow |

electrical data

| | |
|------------------------------------|---------------------------------|
| response time / release time | < 0,125 ms |
| switching frequency | < 4 kHz |
| voltage supply range +Vs | 10 ... 35 VDC |
| current consumption max. (no load) | 30 mA |
| output function | light / dark operate switchable |
| output circuit | PNP |
| voltage drop Vd | < 2,8 VDC |
| output current | < 200 mA |
| short circuit protection | yes |
| reverse polarity protection | yes |

mechanical data

| | |
|-------------------|---------------------|
| width / diameter | 100 mm |
| fork width Sb | 80 mm |
| height / length | 80 mm |
| penetration depth | 55 mm |
| depth | 10 mm |
| type | U profile |
| housing material | die-cast zinc |
| connection types | connector M8, 3 pin |

ambient conditions

| | |
|-----------------------|----------------|
| operating temperature | -10 ... +60 °C |
| protection class | IP 67 |

connectors

| | | |
|--------------|-------|--------------|
| ESG 32SH0200 | 3 pin | 2 m straight |
| ESW 31SH0200 | 3 pin | 2 m angular |

additional cable connectors and field wireable connectors, see accessories

accessories

| | |
|----------------------|----------|
| PNP to NPN-converter | 10149587 |
|----------------------|----------|

for details, see accessories section

order reference

FGUM 080P8001/S35L

dimension drawing

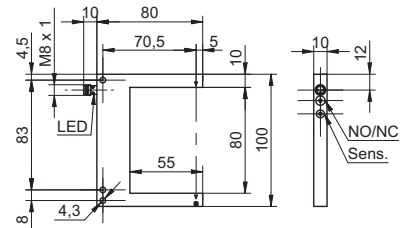

connection diagram

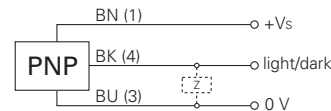

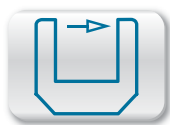

Sb = 120 mm

- sensitivity adjustable via potentiometer
- fork width 120 mm
- rugged metal housing

general data

| | |
|------------------------|---------------------|
| type | through beam sensor |
| object size | > 0,8 mm |
| repeat accuracy | < 0,06 mm |
| hysteresis | < 0,25 mm |
| ambient light immunity | < 50 kLux |
| sensitivity adjustment | potentiometer, 270° |
| light source | pulsed red LED |
| wave length | 660 nm |
| light indicator | LED yellow |

electrical data

| | |
|------------------------------------|---------------------------------|
| response time / release time | < 0,25 ms |
| switching frequency | < 2 kHz |
| voltage supply range +Vs | 10 ... 35 VDC |
| current consumption max. (no load) | 40 mA |
| output function | light / dark operate switchable |
| output circuit | PNP |
| voltage drop Vd | < 2,8 VDC |
| output current | < 200 mA |
| short circuit protection | yes |
| reverse polarity protection | yes |

mechanical data

| | |
|-------------------|---------------------|
| width / diameter | 144 mm |
| fork width Sb | 120 mm |
| height / length | 90 mm |
| penetration depth | 60 mm |
| depth | 12 mm |
| type | U profile |
| housing material | die-cast zinc |
| connection types | connector M8, 3 pin |

ambient conditions

| | |
|-----------------------|----------------|
| operating temperature | -10 ... +60 °C |
| protection class | IP 67 |

connectors

| | | |
|--------------|-------|--------------|
| ESG 32SH0200 | 3 pin | 2 m straight |
| ESW 31SH0200 | 3 pin | 2 m angular |

additional cable connectors and field wireable connectors, see accessories

accessories

| | |
|----------------------|----------|
| PNP to NPN-converter | 10149587 |
|----------------------|----------|

for details, see accessories section



dimension drawing

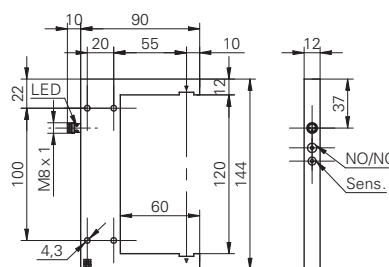

connection diagram

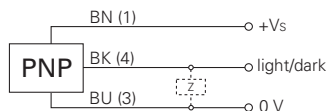

order reference

FGUM 120P8001/S35L

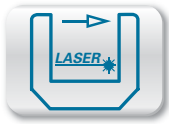

S_b = 30 mm

- precise laser fork sensor in rugged metal housing
- smallest detectable object 0,05 mm
- high repeatability



general data

| | |
|------------------------|------------------------|
| type | through beam sensor |
| object size | > 0,05 mm |
| repeat accuracy | < 0,01 mm |
| hysteresis | < 0,02 mm |
| ambient light immunity | < 100 kLux |
| sensitivity adjustment | potentiometer, 270° |
| light source | pulsed red laser diode |
| wave length | 670 nm |
| laser class | 1 |
| light indicator | LED yellow |

electrical data

| | |
|------------------------------------|---------------------------------|
| response time / release time | < 0,166 ms |
| switching frequency | < 3 kHz |
| voltage supply range +Vs | 10 ... 30 VDC |
| current consumption max. (no load) | 30 mA |
| output function | light / dark operate switchable |
| output circuit | PNP |
| voltage drop V _d | < 2,8 VDC |
| output current | < 200 mA |
| short circuit protection | yes |
| reverse polarity protection | yes |

mechanical data

| | |
|---------------------------|---------------------|
| width / diameter | 60 mm |
| fork width S _b | 30 mm |
| height / length | 60 mm |
| penetration depth | 35 mm |
| depth | 10 mm |
| type | U profile |
| housing material | aluminum anodized |
| connection types | connector M8, 3 pin |

ambient conditions

| | |
|-----------------------|--------------|
| operating temperature | 5 ... +45 °C |
| protection class | IP 67 |

connectors

| | | |
|--------------|-------|--------------|
| ESG 32SH0200 | 3 pin | 2 m straight |
| ESW 31SH0200 | 3 pin | 2 m angular |

additional cable connectors and field wireable connectors, see accessories

accessories

| | |
|----------------------|----------|
| PNP to NPN-converter | 10149587 |
|----------------------|----------|

for details, see accessories section

order reference

OGUM 030P8001/S35L

dimension drawing

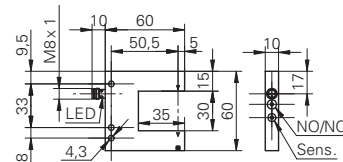

connection diagram

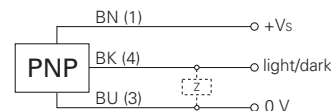

laser warning

**CLASS 1 LASER
PRODUCT**

Complies with 21 CFR 1040.10 and 1040.11
except for deviations pursuant to laser
notice No. 50, dated June 24, 2007

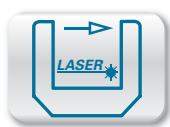

Sb = 50 mm

- precise laser fork sensor in rugged metal housing
- smallest detectable object 0,05 mm
- high repeatability



general data

| | |
|------------------------|------------------------|
| type | through beam sensor |
| object size | > 0,05 mm |
| repeat accuracy | < 0,01 mm |
| hysteresis | < 0,02 mm |
| ambient light immunity | < 100 kLux |
| sensitivity adjustment | potentiometer, 270° |
| light source | pulsed red laser diode |
| wave length | 670 nm |
| laser class | 1 |
| light indicator | LED yellow |

electrical data

| | |
|------------------------------------|---------------------------------|
| response time / release time | < 0,166 ms |
| switching frequency | < 3 kHz |
| voltage supply range +Vs | 10 ... 30 VDC |
| current consumption max. (no load) | 30 mA |
| output function | light / dark operate switchable |
| output circuit | PNP |
| voltage drop Vd | < 2,8 VDC |
| output current | < 200 mA |
| short circuit protection | yes |
| reverse polarity protection | yes |

mechanical data

| | |
|-------------------|---------------------|
| width / diameter | 80 mm |
| fork width Sb | 50 mm |
| height / length | 80 mm |
| penetration depth | 55 mm |
| depth | 10 mm |
| type | U profile |
| housing material | aluminum anodized |
| connection types | connector M8, 3 pin |

ambient conditions

| | |
|-----------------------|--------------|
| operating temperature | 5 ... +45 °C |
| protection class | IP 67 |

connectors

| | | |
|--------------|-------|--------------|
| ESG 32SH0200 | 3 pin | 2 m straight |
| ESW 31SH0200 | 3 pin | 2 m angular |

additional cable connectors and field wireable connectors, see accessories

accessories

| | |
|----------------------|----------|
| PNP to NPN-converter | 10149587 |
|----------------------|----------|

for details, see accessories section

order reference

OGUM 050P8001/S35L

dimension drawing

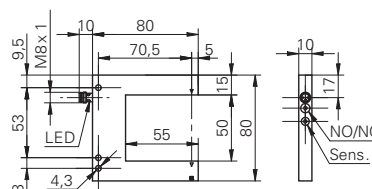

connection diagram

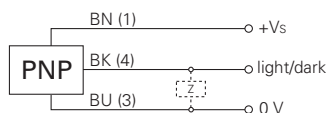

laser warning

CLASS 1 LASER PRODUCT

Complies with 21 CFR 1040.10 and 1040.11 except for deviations pursuant to laser notice No. 50, dated June 24, 2007

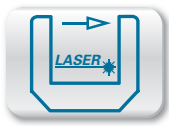

Sb = 80 mm

- precise laser fork sensor in rugged metal housing
- smallest detectable object 0,05 mm
- high repeatability



general data

| | |
|------------------------|------------------------|
| type | through beam sensor |
| object size | > 0,05 mm |
| repeat accuracy | < 0,01 mm |
| hysteresis | < 0,02 mm |
| ambient light immunity | < 100 kLux |
| sensitivity adjustment | potentiometer, 270° |
| light source | pulsed red laser diode |
| wave length | 670 nm |
| laser class | 1 |
| light indicator | LED yellow |

electrical data

| | |
|------------------------------------|---------------------------------|
| response time / release time | < 0,166 ms |
| switching frequency | < 3 kHz |
| voltage supply range +Vs | 10 ... 30 VDC |
| current consumption max. (no load) | 30 mA |
| output function | light / dark operate switchable |
| output circuit | PNP |
| voltage drop Vd | < 2,8 VDC |
| output current | < 200 mA |
| short circuit protection | yes |
| reverse polarity protection | yes |

mechanical data

| | |
|-------------------|---------------------|
| width / diameter | 110 mm |
| fork width Sb | 80 mm |
| height / length | 80 mm |
| penetration depth | 55 mm |
| depth | 10 mm |
| type | U profile |
| housing material | aluminum anodized |
| connection types | connector M8, 3 pin |

ambient conditions

| | |
|-----------------------|--------------|
| operating temperature | 5 ... +45 °C |
| protection class | IP 67 |

connectors

| | | |
|--------------|-------|--------------|
| ESG 32SH0200 | 3 pin | 2 m straight |
| ESW 31SH0200 | 3 pin | 2 m angular |

additional cable connectors and field wireable connectors, see accessories

accessories

| | |
|----------------------|----------|
| PNP to NPN-converter | 10149587 |
|----------------------|----------|

for details, see accessories section

order reference

OGUM 080P8001/S35L

dimension drawing

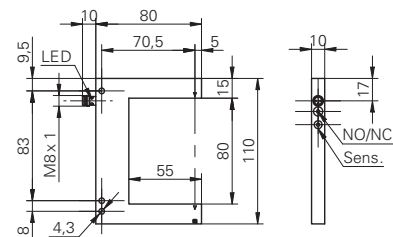

connection diagram

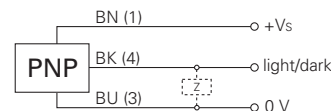

laser warning

**CLASS 1 LASER
PRODUCT**

Complies with 21 CFR 1040.10 and 1040.11
except for deviations pursuant to laser
notice No. 50, dated June 24, 2007

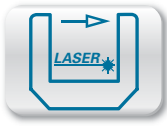

Sb = 120 mm

- precise laser fork sensor in rugged metal housing
- smallest detectable object 0,05 mm
- high repeatability

general data

| | |
|------------------------|------------------------|
| type | through beam sensor |
| object size | > 0,05 mm |
| repeat accuracy | < 0,01 mm |
| hysteresis | < 0,02 mm |
| ambient light immunity | < 100 kLux |
| sensitivity adjustment | potentiometer, 270° |
| light source | pulsed red laser diode |
| wave length | 670 nm |
| laser class | 1 |
| light indicator | LED yellow |

electrical data

| | |
|------------------------------------|---------------------------------|
| response time / release time | < 0,166 ms |
| switching frequency | < 3 kHz |
| voltage supply range +Vs | 10 ... 30 VDC |
| current consumption max. (no load) | 30 mA |
| output function | light / dark operate switchable |
| output circuit | PNP |
| voltage drop Vd | < 2,8 VDC |
| output current | < 200 mA |
| short circuit protection | yes |
| reverse polarity protection | yes |

mechanical data

| | |
|-------------------|---------------------|
| width / diameter | 150 mm |
| fork width Sb | 120 mm |
| height / length | 90 mm |
| penetration depth | 60 mm |
| depth | 12 mm |
| type | U profile |
| housing material | aluminum anodized |
| connection types | connector M8, 3 pin |

ambient conditions

| | |
|-----------------------|--------------|
| operating temperature | 5 ... +45 °C |
| protection class | IP 67 |

connectors

| | | |
|--------------|-------|--------------|
| ESG 32SH0200 | 3 pin | 2 m straight |
| ESW 31SH0200 | 3 pin | 2 m angular |

additional cable connectors and field wireable connectors, see accessories

accessories

| | |
|----------------------|----------|
| PNP to NPN-converter | 10149587 |
|----------------------|----------|

for details, see accessories section

order reference

OGUM 120P8001/S35L



dimension drawing

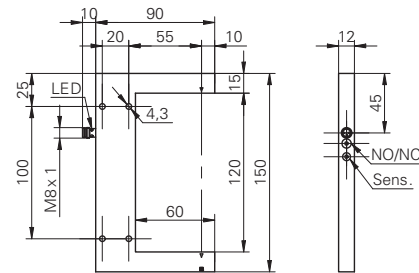

connection diagram

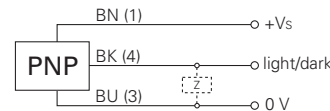

laser warning

CLASS 1 LASER PRODUCT

Complies with 21 CFR 1040.10 and 1040.11 except for deviations pursuant to laser notice No. 50, dated June 24, 2007

OGUM 120 Sb = 120 mm

Fork and angle sensors

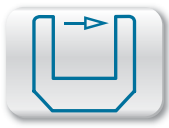

Sb = 60 mm



- optical axis approachable in x-, y- and z-direction
- smallest detectable object 0,5 mm
- rugged metal housing

general data

| | |
|------------------------|---------------------|
| type | through beam sensor |
| object size | > 0,5 mm |
| repeat accuracy | < 0,06 mm |
| hysteresis | < 0,25 mm |
| ambient light immunity | < 80 kLux |
| sensitivity adjustment | potentiometer, 270° |
| light source | pulsed red LED |
| wave length | 660 nm |
| light indicator | LED yellow |

electrical data

| | |
|------------------------------------|---------------------------------|
| response time / release time | < 0,125 ms |
| switching frequency | < 4 kHz |
| voltage supply range +Vs | 10 ... 35 VDC |
| current consumption max. (no load) | 30 mA |
| output function | light / dark operate switchable |
| output circuit | PNP |
| voltage drop Vd | < 2,8 VDC |
| output current | < 200 mA |
| short circuit protection | yes |
| reverse polarity protection | yes |

mechanical data

| | |
|-------------------|---------------------|
| width / diameter | 75 mm |
| fork width Sb | 60 mm |
| height / length | 75 mm |
| penetration depth | 50 mm |
| depth | 10 mm |
| type | L profile |
| housing material | die-cast zinc |
| connection types | connector M8, 3 pin |

ambient conditions

| | |
|-----------------------|----------------|
| operating temperature | -10 ... +60 °C |
| protection class | IP 67 |

connectors

| | | |
|--------------|-------|--------------|
| ESG 32SH0200 | 3 pin | 2 m straight |
| ESW 31SH0200 | 3 pin | 2 m angular |

additional cable connectors and field wireable connectors, see accessories

accessories

| | |
|--------------------------------------|----------|
| PNP to NPN-converter | 10149587 |
| for details, see accessories section | |

order reference

FGLM 050P8001/S35L

dimension drawing

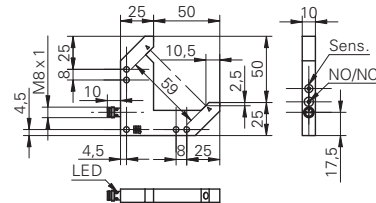

connection diagram

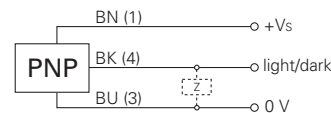

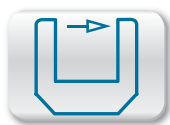

Sb = 100 mm

- optical axis approachable in x-, y- and z-direction
- smallest detectable object 0,7 mm
- rugged metal housing

general data

| | |
|------------------------|---------------------|
| type | through beam sensor |
| object size | > 0,7 mm |
| repeat accuracy | < 0,06 mm |
| hysteresis | < 0,25 mm |
| ambient light immunity | < 70 kLux |
| sensitivity adjustment | potentiometer, 270° |
| light source | pulsed red LED |
| wave length | 660 nm |
| light indicator | LED yellow |

electrical data

| | |
|------------------------------------|---------------------------------|
| response time / release time | < 0,125 ms |
| switching frequency | < 4 kHz |
| voltage supply range +Vs | 10 ... 35 VDC |
| current consumption max. (no load) | 30 mA |
| output function | light / dark operate switchable |
| output circuit | PNP |
| voltage drop Vd | < 2,8 VDC |
| output current | < 200 mA |
| short circuit protection | yes |
| reverse polarity protection | yes |

mechanical data

| | |
|-------------------|---------------------|
| width / diameter | 105 mm |
| fork width Sb | 100 mm |
| height / length | 105 mm |
| penetration depth | 80 mm |
| depth | 10 mm |
| type | L profile |
| housing material | die-cast zinc |
| connection types | connector M8, 3 pin |

ambient conditions

| | |
|-----------------------|----------------|
| operating temperature | -10 ... +60 °C |
| protection class | IP 67 |

connectors

| | | |
|--------------|-------|--------------|
| ESG 32SH0200 | 3 pin | 2 m straight |
| ESW 31SH0200 | 3 pin | 2 m angular |

additional cable connectors and field wireable connectors, see accessories

accessories

| | |
|----------------------|----------|
| PNP to NPN-converter | 10149587 |
|----------------------|----------|

for details, see accessories section

order reference

FGLM 080P8001/S35L



dimension drawing

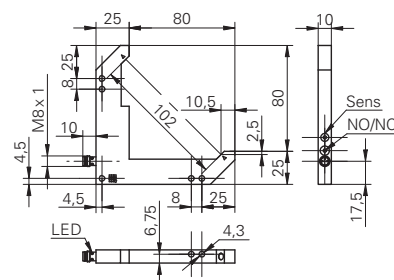

connection diagram

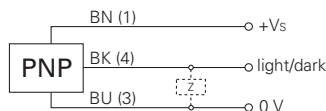

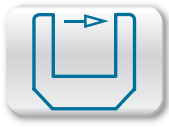

S_b = 158 mm

- optical axis approachable in x-, y- and z-direction
- smallest detectable object 1 mm
- rugged metal housing



general data

| | |
|------------------------|---------------------|
| type | through beam sensor |
| object size | > 1 mm |
| repeat accuracy | < 0,06 mm |
| hysteresis | < 0,25 mm |
| ambient light immunity | < 50 kLux |
| sensitivity adjustment | potentiometer, 270° |
| light source | pulsed red LED |
| wave length | 660 nm |
| light indicator | LED yellow |

electrical data

| | |
|------------------------------------|---------------------------------|
| response time / release time | < 0,25 ms |
| switching frequency | < 2 kHz |
| voltage supply range +Vs | 10 ... 35 VDC |
| current consumption max. (no load) | 40 mA |
| output function | light / dark operate switchable |
| output circuit | PNP |
| voltage drop V _d | < 2,8 VDC |
| output current | < 200 mA |
| short circuit protection | yes |
| reverse polarity protection | yes |

mechanical data

| | |
|---------------------------|---------------------|
| width / diameter | 150 mm |
| fork width S _b | 158 mm |
| height / length | 150 mm |
| penetration depth | 120 mm |
| depth | 12 mm |
| type | L profile |
| housing material | die-cast zinc |
| connection types | connector M8, 3 pin |

ambient conditions

| | |
|-----------------------|----------------|
| operating temperature | -10 ... +60 °C |
| protection class | IP 67 |

connectors

| | | |
|--------------|-------|--------------|
| ESG 32SH0200 | 3 pin | 2 m straight |
| ESW 31SH0200 | 3 pin | 2 m angular |

additional cable connectors and field wireable connectors, see accessories

accessories

| | |
|----------------------|----------|
| PNP to NPN-converter | 10149587 |
|----------------------|----------|

for details, see accessories section

order reference

FGLM 120P8001/S35L

dimension drawing

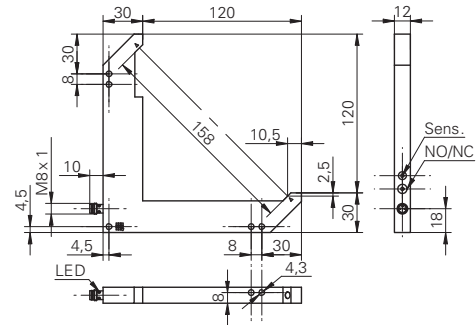

connection diagram

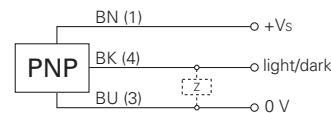





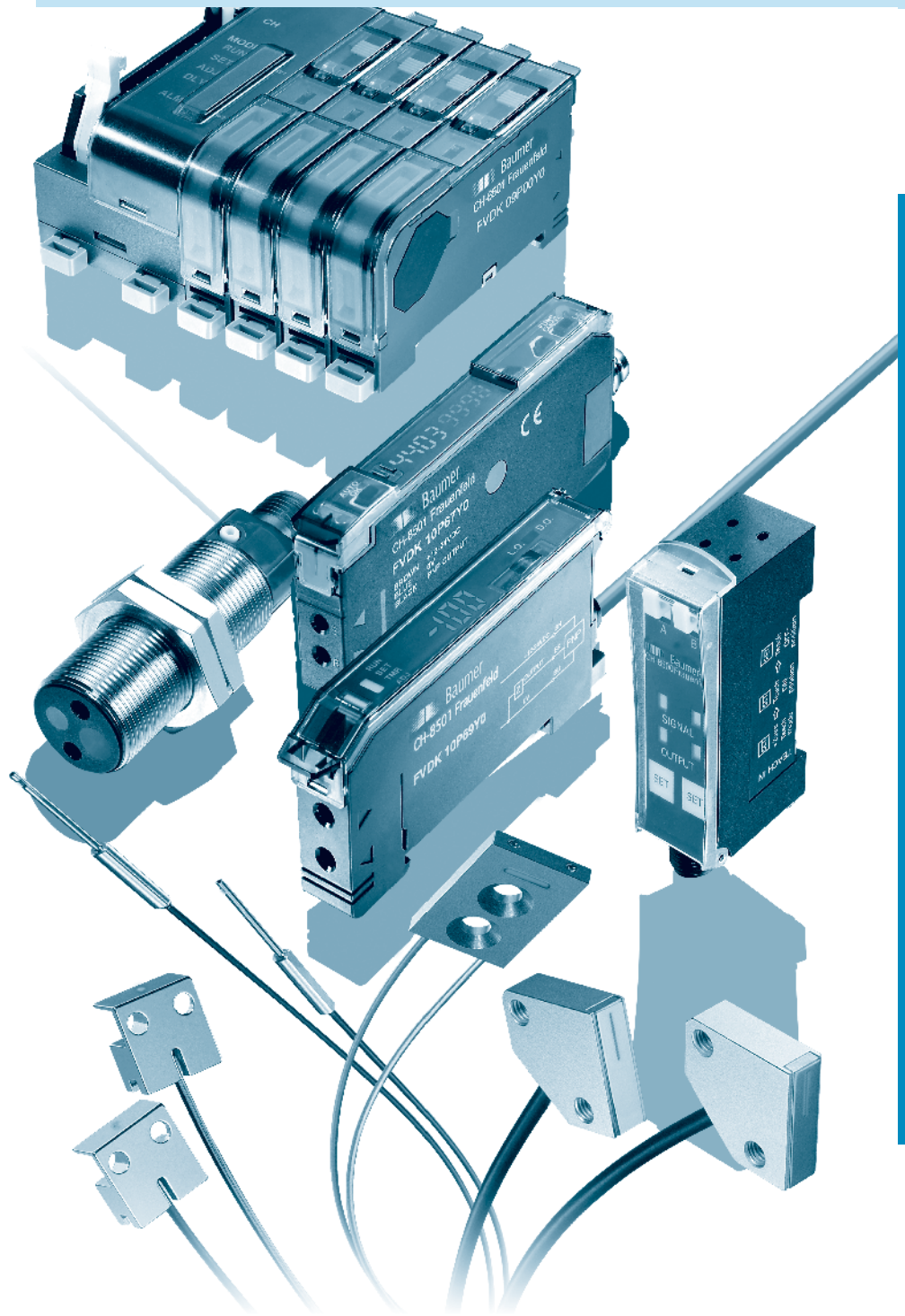



Fiber optics and fiber optic sensors



Plastic fiber optic sensors
Plastic fiber optics
Glass fiber optic sensors
Glass fiber optics

Page 304
Page 324
Page 333
Page 340

| product family | FVDK 10 | FVDK 80 | FVDK 66 | FVDK 66 | FVDK 67 | FVDK 67 | FVDK 67 |
|------------------------------------|---|---|---|--|---|---|---|
| |  |  |  |  |  |  |  |
| version | | small hysteresis fast version high sensitivity | | master slave | | master slave | 2 outputs |
| width / diameter | 10,4 mm | 10 mm | 10 mm | 10 mm | 10 mm | 10 mm | 10 mm |
| actual range Sb (FSE 200C1002) | 160 mm | 100 mm 240 mm 440 mm | 340 mm | 340 mm | 1200 mm | 1200 mm | 1200 mm |
| sensing distance Tw (FUE 200C1003) | 45 mm | 30 mm 70 mm 120 mm | 130 mm | 130 mm | 300 mm | 300 mm | 300 mm |
| response time / release time | < 1 ms | < 0,05 ms < 0,5 ms | 0,25 ... 1 ms | 0,25 ... 1 ms | 0,05 ... 5 ms 0,058 ... 5 ms | 0,05 ... 5 ms 0,058 ... 5 ms | 0,14 ... 5 ms |
| analog 1 ... 5 VDC | | | | | | | |
| NPN | ■ | ■ | ■ | ■ | ■ | ■ | ■ |
| PNP | ■ | ■ | ■ | ■ | ■ | ■ | ■ |
| cable | ■ | ■ | ■ | ■ | ■ | ■ | ■ |
| flylead connector | | ■ | | | | | |
| connector | ■ | | ■ | | ■ | | ■ |
| housing material | plastic | plastic | plastic | plastic | plastic | plastic | plastic |
| | | | | | | | |
| page | 312 | 313 | 314 | 315 | 316 | 317 | 318 |

Overview
Plastic fiber optic sensors

Plastic fiber optic sensors

FVDK 12 FVDK 12 FVDK 22 FWDK 84



| | | | |
|-------------------------|--------------|-------------------------|-------|
| integrated alarm output | fast version | integrated alarm output | |
| 12 mm | 12 mm | 22 mm | 10 mm |
| 320 mm | 140 mm | 320 mm | 90 mm |

| | | | |
|-------|-------|-------|-------|
| 90 mm | 40 mm | 90 mm | 25 mm |
|-------|-------|-------|-------|

| | | | |
|--------|-----------|--------|-------------|
| < 1 ms | < 0,05 ms | < 1 ms | 1 ... 50 ms |
|--------|-----------|--------|-------------|

| | | | |
|--|--|--|---|
| | | | ■ |
|--|--|--|---|

| | | | |
|---|--|--|--|
| ■ | | | |
|---|--|--|--|

| | | | |
|---|---|---|--|
| ■ | ■ | ■ | |
|---|---|---|--|

| | | | |
|---|--|---|---|
| ■ | | ■ | ■ |
|---|--|---|---|

| | | | |
|--|--|--|--|
| | | | |
|--|--|--|--|

| | | | |
|---|---|---|--|
| ■ | ■ | ■ | |
|---|---|---|--|

| | | | |
|---------|---------|---------|---------|
| plastic | plastic | plastic | plastic |
|---------|---------|---------|---------|

| | | | |
|--|--|--|--|
| | | | |
|--|--|--|--|

| | | | |
|------------|------------|------------|------------|
| 319 | 320 | 321 | 322 |
|------------|------------|------------|------------|



General information

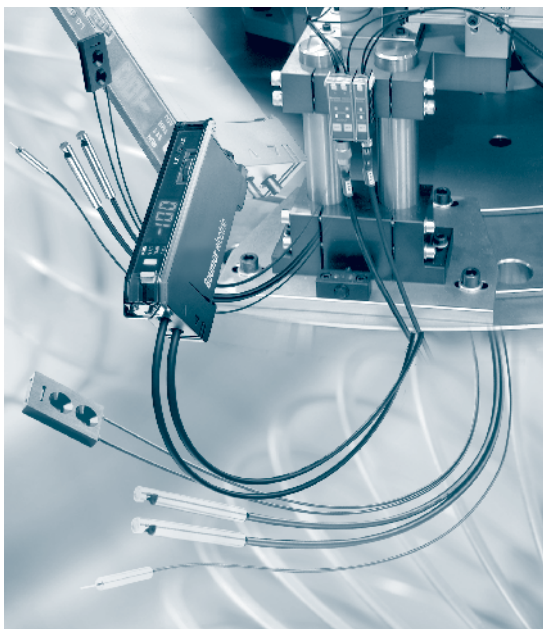

Fiber optics are the extended vision of conventional sensors and, due to their miniature construction, can be installed directly in the most difficult ambient conditions. As only light is conveyed, fiber optics are intrinsically safe, which adds to their range of applications. Plastic fiber optics are characterized primarily by the properties of the employed raw material – the plastic. Advances in the manufacture of plastics permit bending radii of just 1 mm for the optical fibers, which is completely impossible for glass fibers. Fiber materials are now available which are extremely tolerant to bending and thereby make their use in drag chains possible.

Typical applications

Due to their versatility, optical fibers can be used in the most diverse applications. The small, space-saving sensing heads are very suitable for use in very constricted conditions. It is also possible to monitor whole areas or execute precise positioning by the different arrangements of the fibers.

- Due to the light weight and space-saving construction, optical fibers can be integrated directly in pick & place tools
- Detection, differentiation and positioning of the most diverse objects
- Monitoring of whole areas with fiber optic arrays with linear fiber arrangement
- Use at high, low or constantly fluctuating ambient temperatures
- Detection of levels or leaks, including hazardous liquids
- Detection of transparent media such as glass, wafers or films with focused fiber optic reflective types



Characteristics and advantages

Independent of the environment

As only light is conveyed, electromagnetic fields, high or low temperatures have no effect on the functional reliability.

Space-saving

The smallest sensing heads have a diameter of 1,5 mm and are only 10 mm long. With bending radii of just 1 mm, it is possible to integrate the eye of the sensor even in the most constricted places.

Precise light spots

Fiber cross-sections of only 0,25 mm generate a fine core beam in fiber optic through beam types, whereas doubling lenses in fiber optic reflective types permit precise light spots of 0,1 mm.

Application-specific fiber arrangement

The coaxial fiber arrangement permits optimum light distribution over the receiver fibers and thereby makes precise positioning of objects possible. Also, fiber optic arrays with a linear fiber arrangement allow a whole area to be monitored or the detection of randomly conveyed objects.

Application feedback

Multi-digit displays integrated in the fiber optic sensors permit the stability of the application to be assessed and make fault analyses possible.

Fast processes

Fiber optic sensors with response times of only 50 microseconds allow the detection of objects even in very fast processes.



Technology and operation

The technology is based on intensity differences. The fiber optic through beam types detect an object breaking the light beam between the emitter and receiver. The fiber optic reflective types evaluate the amount of light reflected back from an object. The high-resolution analog/digital conversion in the fiber optic sensors permits very slight changes to be evaluated. This is important where the detection of small objects or differentiation of the finest contrasts is demanded.

Fundamentally, the fiber optics form a unit with the corresponding processing units, and the type of fiber optic head is mainly decisive for the detection of objects. The table below is intended to provide aid in understanding the large range of different sensing heads:

| Version/type | Properties | Field of application | Example types |
|-------------------------------|--|--|--|
| Standard | Large selection of different shapes. Economical | Standard applications, simple object detection | FUE 200C1002 FUE 200C1004 |
| Coaxial | Homogenous light distribution over all receiver fibers. Lens adaptation possible | Optimally suited for positioning tasks. Highly accurate in combination with focusing lenses | FCE 200C1Y00 FCE 200D1Y00 |
| Side light exit | 90° light exit Reduced beam angle More installation space | Constricted conditions | FUE 200C4Y00 FSE 200C4002 |
| Array | Linear arrangement of the fibers. Line lengths of 5,25 – 21 mm. Reflective or through beam types | Detection of objects which cannot be precisely conveyed. Measurement of object sizes or edge positions | FUE 200C6Y00 FSE 200C6Y00 |
| Longer range Parallel beam | Integrated lens Small beam angle Long range | Object detection and positioning over a long distance. No influencing by interfering objects close to the optical fiber | FLE 200C1Y00 FPE 200C1Y00 |
| Highly flexible | Min. bending radius down to 1 mm Suitable for flexible installation | Constricted conditions | FUE 200E1Y00 FSE 200F6Y00 |
| Bendable | Extremely bendable, designed for bending more than 1 million times. | For use in drag chains or on moving parts | FUE 100E2Y00 FSE 200D1Y50 |
| Small light spot | In combination with focusing lenses, a light spot of only 0,1 mm can be produced. | Detection of very small objects Highly accurate edge positioning | FCE 050C1Y10 with lens 134544 |
| Level detection | Special sensing tip to avoid liquid residues. Version for pipe/hose fitting | Detection of levels in different liquids, in or out of contact | FUL 200D2Y00 FSL 500C6Y00 FOC 500C6900 |
| Spezial versions | Heat and cold resistant Chemical and oil resistant | For extreme environmental. Conditions such as chemical or aggressive surroundings or temperatures from -60 ... +350 °C | FUG 200C1900 FSC 200C4400 |



Fiber optic sensors of the ranges FVDK 66 and FVDK 67 – versatile and multifunctional

The generation of multifunction fiber optic sensors is particularly suitable for handling processes, where very fast movements as well as exact positioning or the detection of very small objects are important. A single sensor undertakes the tasks which were formerly performed by many different sensors. The user can choose from 3 to 8 different operating modes from very short response time to high sensitivity to adapt the sensor optimally to his application. Despite the all-in-one concept, the requirement for simple operation is also fulfilled.

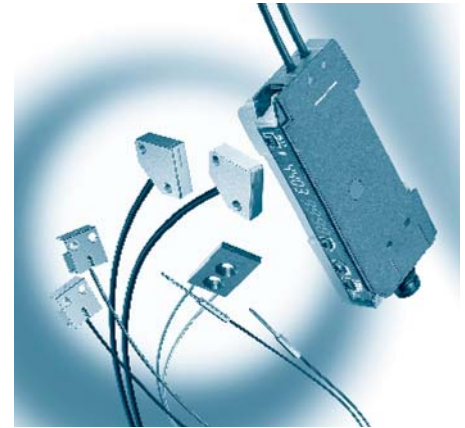

| | FVDK 67 | FVDK 66 |
|--------------------------------------|--|---|
| Sensing range (FSE 200C1002) | 1200 mm | 340 mm |
| Sensing distance (FUE 200C1003) | 300 mm | 130 mm |
| Min. response time | 50 µsec | 250 µsec |
| Speed / sensing modes | 5 levels | 3 levels |
| Adjustment | Automatically via teach-in manually with +/- button | Automatically via teach-in manually with +/- button |
| Suppression of reciprocal influences | 8 sensors | 2 sensors |
| Long-term stability | yes | yes |
| Timer | On- or Off-Delay On- and Off-Delay One-Shot One-Shot and On-Delay | On- or Off-Delay |
| Available versions | Standard With external teach-in Master/Slave 2 switching outputs | Standard With external teach-in Master/Slave |
| Additional functions | Factory setup Rotate display Delay / freeze display Keylock Chemical and oil resistant | Factory setup Rotate display |

Reduced wiring

With the master/slave version up to 16 sensors can be connected together to one unit (consisting of one master and the appropriate number of slaves). Only the power of the master has to be wired. The slaves are supplied through the side plug. For maximum flexibility in the wiring of the individual sensor signals each slave has a single-core cable. Series 66 and 67 can be combined in any order.

Application feedback

The application feedback is particularly important during commissioning if consistent detection is to be ensured. The switching point and the relative received signal are indicated simultaneously on the 2x4 digit display of the FVDK 67 range. With this information it can be determined at a glance whether the switching point has been optimally adjusted.

Long-term stability

In both sensor series measures have been taken to ensure the long-term stability of the switching function. This is done either by compensating the aging of the emitting LED or by repositioning the switching threshold.



Teach-in or potentiometer? Just simple operation

The fiber optic sensors of the FVDK 12, 22, 60, 80 and FWDK 84 ranges are characterized particularly by their simple handling. The sensitivity can be adjusted either with a potentiometer or a Teach-in button. Differently colored LEDs or simple displays provide the adjustment feedback. The sensor ranges differ primarily in their speed, sensitivity, hysteresis functions and supplementary functions such as timers, external Teach-in or logical output gates. However, all have the same thing in common: regardless of where the sensor is installed, the adjustment can be made practically without the need for operating instructions.

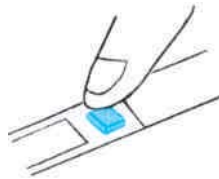
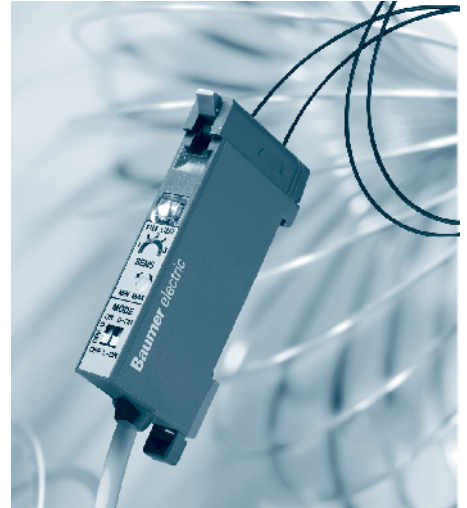

Type FVDK 12

- Integrated, dynamic Teach-in allows the most reliable detection of moving objects or small parts for which it is difficult to find an exact Teach-in position
- High-speed version with a response time of only 50 μ s
- Integrated alarm output warns in advance of excessive soiling
- Protection class IP 65



Type FVDK 22

- Two sensors in one housing reduces the necessary wiring
- The two integrated sensors do not interfere with each other
- It is possible to link the two outputs logically
- Version with external Teach-in from the controller



Teach-in or potentiometer?
Just simple operation



Type FVDK 10

- Smallest fiber optic sensor
- Easy and quick sensitivity adjustment with potentiometer
- Protection against optical interference between up to 3 optical fibers

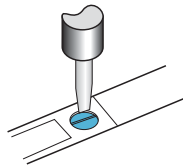

Type FVDK 80

- 3-turn potentiometer allows accurate adjustment of the sensitivity
- Version with low hysteresis of 10 % (full scale) permits accurate positioning
- High-speed version with a response time of only 50 μ s
- Integrated alarm output warns in advance of excessive soiling
- Protection against optical interference between up to 3 optical fibers

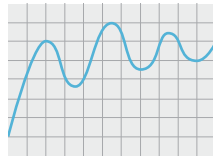

Type FWDK 84

- Analog voltage output 1 – 5 VDC
- Adjustable resolution of 0,3 to 6 % (full scale)
- In combination with a fiber optic array, object sizes or positions can be determined within a range of up to 21 mm

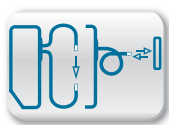

S_b = 160 mm
Tw = 45 mm

- sensitivity adjustable via potentiometer
- suppression of mutual optical interference

general data

| | |
|--|--------------------------|
| actual range S _b (FSE 200C1002) | 160 mm |
| sensing distance Tw (FUE 200C1003) | 45 mm |
| light source | pulsed red LED |
| light indicator | LED yellow |
| alignment / soiled lens indicator | flashing light indicator |
| adjustment | potentiometer, 270° |
| wave length | 660 nm |
| suppression of reciprocal influence | yes |

electrical data

| | |
|------------------------------------|----------------------|
| response time / release time | < 1 ms |
| voltage supply range +Vs | 10 ... 30 VDC |
| current consumption max. (no load) | 30 mA |
| current consumption typ. | 20 mA |
| voltage drop V _d | < 1,8 VDC |
| output function | light / dark operate |
| output current | < 100 mA |
| short circuit protection | yes |
| reverse polarity protection | yes |

mechanical data

| | |
|------------------|---------------|
| width / diameter | 10,4 mm |
| height / length | 27 mm |
| depth | 14 mm |
| type | rectangular |
| housing material | plastic (ASA) |

ambient conditions

| | |
|-----------------------|----------------|
| operating temperature | -25 ... +55 °C |
| protection class | IP 40 |

connectors

| | | |
|--|-------|--------------|
| ESG 32AH0200 | 4 pin | 2 m straight |
| ESW 31AH0200 | 4 pin | 2 m angular |
| additional cable connectors and field wireable connectors, see accessories | | |

accessories

| | |
|--------------------------------------|----------|
| SENSOFIX mounting kit | 10150326 |
| mounting bracket (cable type) | 10114501 |
| mounting bracket (connector type) | 10133792 |
| for details, see accessories section | |

| order reference | output circuit | connection types |
|--------------------------|----------------|------------------|
| FVDK 10N5101 | NPN | cable, 2 m |
| FVDK 10N5101/S35A | NPN | connector M8 |
| FVDK 10P5101 | PNP | cable, 2 m |
| FVDK 10P5101/S35A | PNP | connector M8 |



dimension drawings

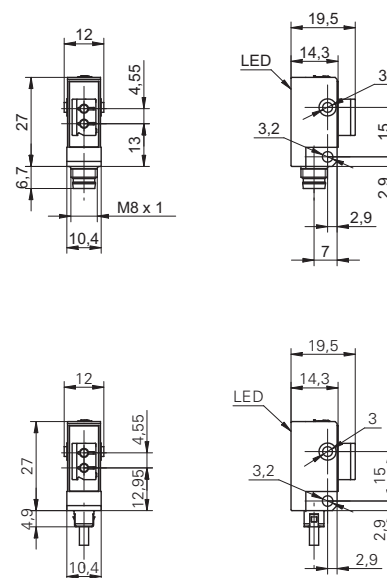

connection diagrams

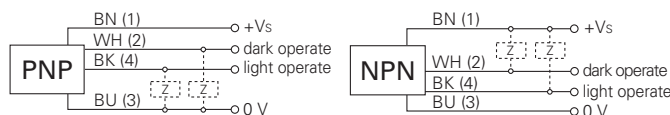

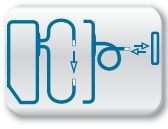

S_b = 440 mm
Tw = 120 mm



- sensitivity adjustable via potentiometer
- fast and high sensitivity version available
- integrated alarm output

general data

| | |
|-------------------------------------|---------------------|
| light source | pulsed red LED |
| light indicator | LED green |
| alignment / soiled lens indicator | LED green, flashing |
| output indicator | LED red |
| adjustment | potentiometer |
| wave length | 680 nm |
| suppression of reciprocal influence | yes |

electrical data

| | |
|------------------------------------|---------------------------------|
| voltage supply range +Vs | 10 ... 30 VDC |
| current consumption max. (no load) | 35 mA |
| voltage drop Vd | < 1 VDC |
| output function | light / dark operate switchable |
| off delay | 40 ms |
| output current | < 100 mA |
| short circuit protection | yes |
| reverse polarity protection | yes |

mechanical data

| | |
|------------------|-------------------|
| width / diameter | 10 mm |
| height / length | 29,7 mm |
| depth | 60 mm |
| type | rectangular |
| housing material | polycarbonate/ABS |

ambient conditions

| | |
|-----------------------|----------------|
| operating temperature | -20 ... +60 °C |
| protection class | IP 40 |

connectors

| | | |
|--|-------|--------------|
| ESG 32AH0200 | 4 pin | 2 m straight |
| ESW 31AH0200 | 4 pin | 2 m angular |
| additional cable connectors and field wireable connectors, see accessories | | |

dimension drawings

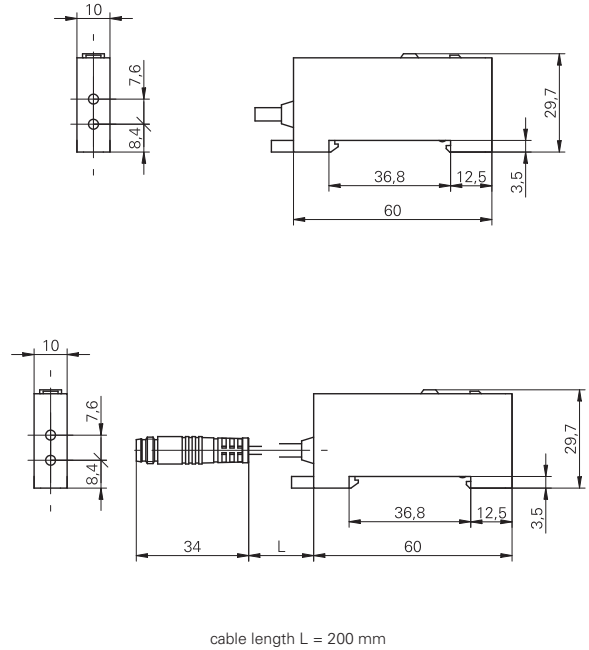

connection diagrams

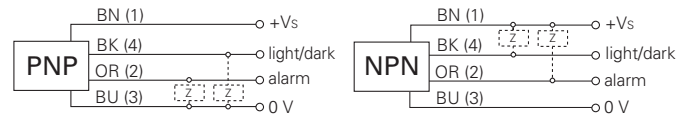

| order reference | actual range S _b (FSE 200C1002) | sensing distance Tw (FUE 200C1003) | response time / release time | output circuit | connection types | version |
|--------------------|---|---------------------------------------|-----------------------------------|----------------|----------------------------|------------------|
| FVDK 10N81Y0 | 240 mm | 70 mm | < 0,5 ms | NPN | cable, 2 m | small hysteresis |
| FVDK 10N82Y0 | 100 mm | 30 mm | < 0,05 ms (release time +0.02 ms) | NPN | cable, 2 m | fast version |
| FVDK 10N83Y0 | 440 mm | 120 mm | < 0,5 ms | NPN | cable, 2 m | high sensitivity |
| FVDK 10P81Y0 | 240 mm | 70 mm | < 0,5 ms | PNP | cable, 2 m | small hysteresis |
| FVDK 10P81Y0/KS35A | 240 mm | 70 mm | < 0,5 ms | PNP | flylead connector M8 4 pin | small hysteresis |
| FVDK 10P82Y0 | 100 mm | 30 mm | < 0,05 ms (release time +0.02 ms) | PNP | cable, 2 m | fast version |
| FVDK 10P82Y0/KS35A | 100 mm | 30 mm | < 0,05 ms (release time +0.02 ms) | PNP | flylead connector M8 4 pin | fast version |
| FVDK 10P83Y0 | 440 mm | 120 mm | < 0,5 ms | PNP | cable, 2 m | high sensitivity |
| FVDK 10P83Y0/KS35A | 440 mm | 120 mm | < 0,5 ms | PNP | flylead connector M8 4 pin | high sensitivity |

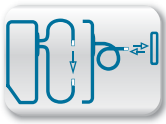

S_b = 340 mm
Tw = 130 mm

- 2x4 digit display indicates the switching point and receiving light level
- easy operation



general data

| | |
|--|---------------------|
| actual range S _b (FSE 200C1002) | 340 mm |
| sensing distance Tw (FUE 200C1003) | 130 mm |
| light source | pulsed red LED |
| light indicator | 2 x 4-digit display |
| output indicator | LED yellow |
| wave length | 645 nm |
| suppression of reciprocal influence | yes |

electrical data

| | |
|------------------------------------|---------------------------------|
| response time / release time | 0,25 ... 1 ms (adjustable) |
| voltage supply range +Vs | 10,8 ... 26,4 VDC |
| current consumption max. (no load) | 30 mA |
| voltage drop V _d | < 2,1 VDC |
| output function | light / dark operate switchable |
| on / off delay | 1 ... 5000 ms |
| output current | < 100 mA |
| short circuit protection | yes |
| reverse polarity protection | yes |

mechanical data

| | |
|------------------|-------------------|
| width / diameter | 10 mm |
| height / length | 33,8 mm |
| depth | 70,2 mm |
| type | rectangular |
| housing material | polycarbonate/ABS |

ambient conditions

| | |
|-----------------------|----------------|
| operating temperature | -20 ... +55 °C |
| protection class | IP 40 |

connectors

| | | |
|--------------|-------|--------------|
| ESG 32AH0200 | 4 pin | 2 m straight |
| ESW 31AH0200 | 4 pin | 2 m angular |

additional cable connectors and field wireable connectors, see accessories

accessories

| | |
|---|----------|
| mounting bracket for mounting on DIN Rail | 10159806 |
| for details, see accessories section | |

dimension drawing

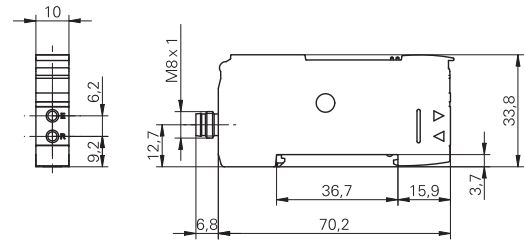

connection diagrams

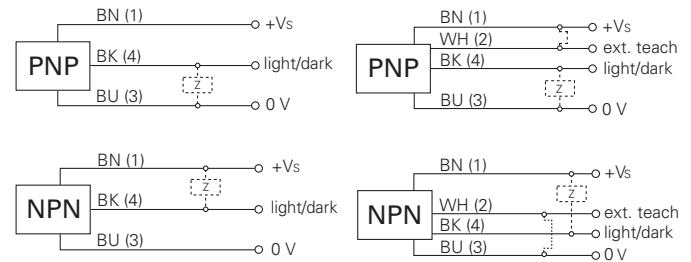

| order reference | adjustment | output circuit | connection types |
|-------------------|-----------------------------|----------------|--------------------|
| FVDK 10N66Y0 | Teach-in | NPN | cable, 2 m |
| FVDK 10N66Y0/S35A | Teach-in | NPN | connector M8 4 pin |
| FVDK 10N66YR | Teach-in: button / external | NPN | cable, 2 m |
| FVDK 10P66Y0 | Teach-in | PNP | cable, 2 m |
| FVDK 10P66Y0/S35A | Teach-in | PNP | connector M8 4 pin |
| FVDK 10P66YR | Teach-in: button / external | PNP | cable, 2 m |

FVDK 66 Sb = 340 mm, Tw = 130 mm

Plastic fiber optic sensors

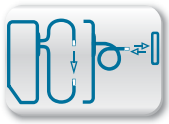

S_b = 340 mm
Tw = 130 mm

- master/slave system with up to 15 extension units
- 2x4 digit display



general data

| | |
|--|---------------------|
| actual range S _b (FSE 200C1002) | 340 mm |
| sensing distance Tw (FUE 200C1003) | 130 mm |
| light source | pulsed red LED |
| light indicator | 2 x 4-digit display |
| output indicator | LED yellow |
| adjustment | Teach-in |
| wave length | 645 nm |
| suppression of reciprocal influence | yes |

electrical data

| | |
|------------------------------------|---------------------------------|
| response time / release time | 0,25 ... 1 ms (adjustable) |
| voltage supply range +Vs | 10,8 ... 26,4 VDC |
| current consumption max. (no load) | 30 mA |
| voltage drop V _d | < 2,1 VDC |
| output function | light / dark operate switchable |
| on / off delay | 1 ... 5000 ms |
| output current | < 100 mA |
| short circuit protection | yes |
| reverse polarity protection | yes |

mechanical data

| | |
|------------------|-------------------|
| width / diameter | 10 mm |
| height / length | 33,8 mm |
| depth | 70,2 mm |
| type | rectangular |
| housing material | polycarbonate/ABS |
| connection types | cable, 2 m |

ambient conditions

| | |
|-----------------------|----------------|
| operating temperature | -20 ... +55 °C |
| protection class | IP 40 |

accessories

| | |
|---|----------|
| mounting bracket for mounting on DIN Rail | 10159806 |
| for details, see accessories section | |

dimension drawing

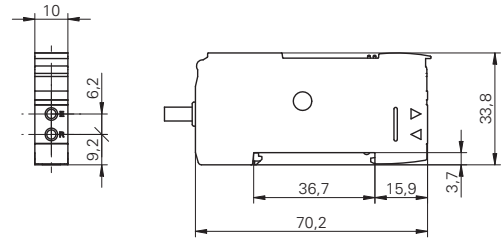

connection diagrams

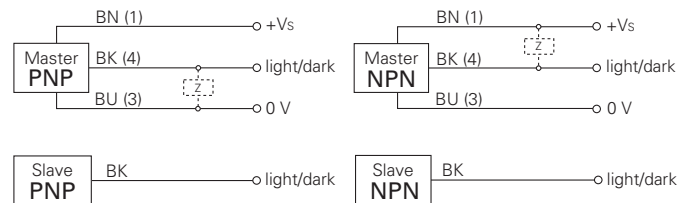

| order reference | output circuit | version |
|-----------------|----------------|---------|
| FVDK 10N66YM | NPN | master |
| FVDK 10N66YS | NPN | slave |
| FVDK 10P66YM | PNP | master |
| FVDK 10P66YS | PNP | slave |

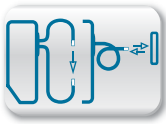

S_b = 1200 mm
Tw = 300 mm

- 2x4 digit display indicates the switching point and receiving light level
- versatile applicable due to 8 integrated operating



| general data | |
|--|---------------------------------|
| actual range S _b (FSE 200C1002) | 1200 mm |
| sensing distance Tw (FUE 200C1003) | 300 mm |
| light source | pulsed red LED |
| light indicator | 2 x 4-digit display |
| output indicator | LED orange |
| wave length | 660 nm |
| suppression of reciprocal influence | yes |
| electrical data | |
| voltage supply range +Vs | 10,8 ... 26,4 VDC |
| current consumption max. (no load) | 30 mA |
| voltage drop V _d | < 2,1 VDC |
| output function | light / dark operate switchable |
| on / off delay | 0,25 ... 20000 ms |
| min. output pulse length | 0,25 ... 20000 ms |
| short circuit protection | yes |
| reverse polarity protection | yes |
| mechanical data | |
| width / diameter | 10 mm |
| height / length | 33,8 mm |
| depth | 70,2 mm |
| type | rectangular |
| housing material | polycarbonate/ABS |
| ambient conditions | |
| operating temperature | -20 ... +55 °C |
| protection class | IP 40 |
| connectors | |
| ESG 32AH0200 | 4 pin 2 m straight |
| ESW 31AH0200 | 4 pin 2 m angular |
| additional cable connectors and field wireable connectors, see accessories | |
| accessories | |
| mounting bracket for mounting on DIN Rail | 10159806 |
| for details, see accessories section | |

dimension drawings

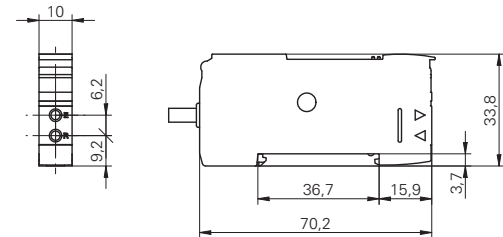
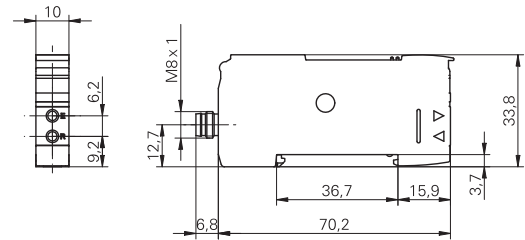

connection diagrams

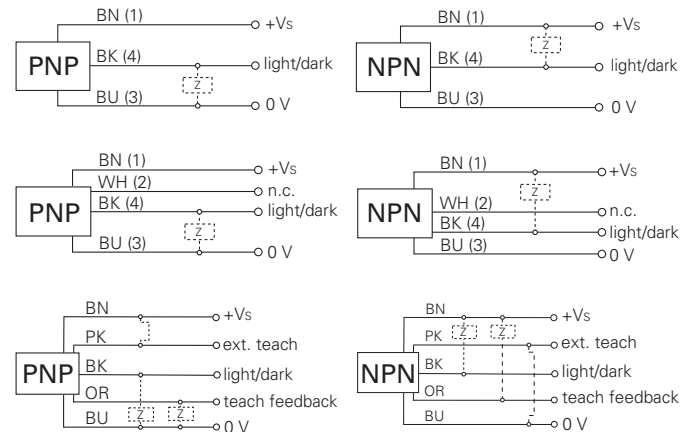

| order reference | adjustment | response time / release time | output circuit | output current | connection types |
|-------------------|-----------------------------|------------------------------|----------------|----------------|--------------------|
| FVDK 10N67Y0 | Teach-in | 0,05 ... 5 ms (adjustable) | NPN | < 100 mA | cable, 2 m |
| FVDK 10N67Y0/S35A | Teach-in | 0,05 ... 5 ms (adjustable) | NPN | < 100 mA | connector M8 4 pin |
| FVDK 10N67YR | Teach-in: button / external | 0,05 ... 5 ms (adjustable) | NPN | < 50 mA | cable, 2 m |
| FVDK 10P67Y0 | Teach-in | 0,058 ... 5 ms (adjustable) | PNP | < 100 mA | cable, 2 m |
| FVDK 10P67Y0/S35A | Teach-in | 0,058 ... 5 ms (adjustable) | PNP | < 100 mA | connector M8 4 pin |
| FVDK 10P67YR | Teach-in: button / external | 0,058 ... 5 ms (adjustable) | PNP | < 50 mA | cable, 2 m |

FVDK 67 Sb = 1200 mm, Tw = 300 mm Plastic fiber optic sensors

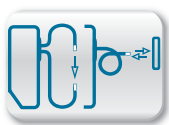

S_b = 1200 mm
Tw = 300 mm



- master/slave system with up to 16 extension units
- integrated dynamic auto-teach-in function
- 2x4 digit display

general data

| | |
|--|---------------------|
| actual range S _b (FSE 200C1002) | 1200 mm |
| sensing distance Tw (FUE 200C1003) | 300 mm |
| light source | pulsed red LED |
| light indicator | 2 x 4-digit display |
| output indicator | LED orange |
| adjustment | Teach-in |
| wave length | 660 nm |
| suppression of reciprocal influence | yes |

electrical data

| | |
|------------------------------------|---------------------------------|
| voltage supply range +Vs | 10,8 ... 26,4 VDC |
| current consumption max. (no load) | 30 mA |
| voltage drop V _d | < 2,1 VDC |
| output function | light / dark operate switchable |
| on / off delay | 0,25 ... 20000 ms |
| min. output pulse length | 0,25 ... 20000 ms |
| output current | < 50 mA |
| short circuit protection | yes |
| reverse polarity protection | yes |

mechanical data

| | |
|------------------|-------------------|
| width / diameter | 10 mm |
| height / length | 33,8 mm |
| depth | 70,2 mm |
| type | rectangular |
| housing material | polycarbonate/ABS |

ambient conditions

| | |
|-----------------------|----------------|
| operating temperature | -20 ... +55 °C |
| protection class | IP 40 |

accessories

| | |
|---|----------|
| mounting bracket for mounting on DIN Rail | 10159806 |
| for details, see accessories section | |

dimension drawing

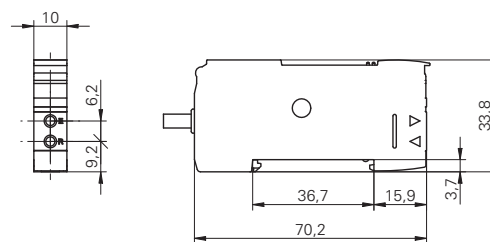

connection diagrams

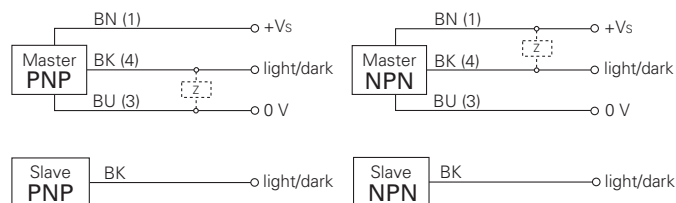

| order reference | response time / release time | output circuit | connection types | version |
|-----------------|------------------------------|----------------|--------------------------|---------|
| FVDK 10N67YM | 0,05 ... 5 ms (adjustable) | NPN | cable, 2 m | master |
| FVDK 10N67YS | 0,05 ... 5 ms (adjustable) | NPN | cable (output only), 2 m | slave |
| FVDK 10P67YM | 0,058 ... 5 ms (adjustable) | PNP | cable, 2 m | master |
| FVDK 10P67YS | 0,058 ... 5 ms (adjustable) | PNP | cable (output only), 2 m | slave |

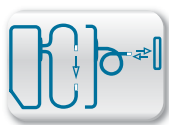

S_b = 1200 mm
Tw = 300 mm

- 2 independently adjustable outputs
- suppression of mutual optical interference
- 2x4 digit display

general data

| | |
|--|---------------------|
| version | 2 outputs |
| actual range S _b (FSE 200C1002) | 1200 mm |
| sensing distance Tw (FUE 200C1003) | 300 mm |
| light source | pulsed red LED |
| light indicator | 2 x 4-digit display |
| output indicator | LED orange |
| adjustment | Teach-in |
| wave length | 660 nm |
| suppression of reciprocal influence | yes |

electrical data

| | |
|------------------------------------|---------------------------------|
| response time / release time | 0,14 ... 5 ms (adjustable) |
| voltage supply range +Vs | 10,8 ... 26,4 VDC |
| current consumption max. (no load) | 30 mA |
| voltage drop V _d | < 2,1 VDC |
| output function | light / dark operate switchable |
| on / off delay | 0,25 ... 20000 ms |
| min. output pulse length | 0,25 ... 20000 ms |
| output current | < 30 mA |
| short circuit protection | yes |
| reverse polarity protection | yes |

mechanical data

| | |
|------------------|-------------------|
| width / diameter | 10 mm |
| height / length | 33,8 mm |
| depth | 70,2 mm |
| type | rectangular |
| housing material | polycarbonate/ABS |

ambient conditions

| | |
|-----------------------|----------------|
| operating temperature | -20 ... +55 °C |
| protection class | IP 40 |

accessories

| | |
|---|----------|
| mounting bracket for mounting on DIN Rail | 10159806 |
| for details, see accessories section | |

| order reference | output circuit | connection types |
|-------------------|----------------|--------------------|
| FVDK 10N67Y2 | NPN | cable, 2 m |
| FVDK 10P67Y2/S35A | PNP | connector M8 4 pin |

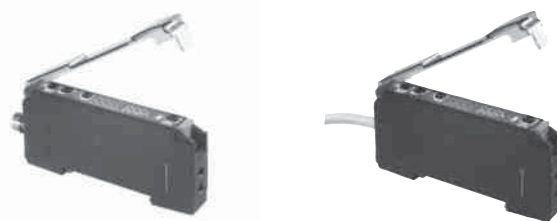

dimension drawings

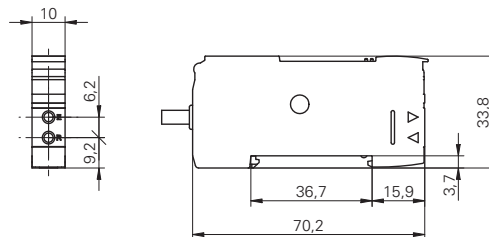
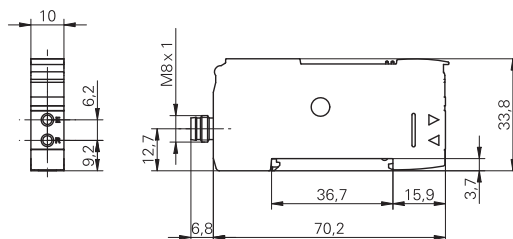

connection diagrams

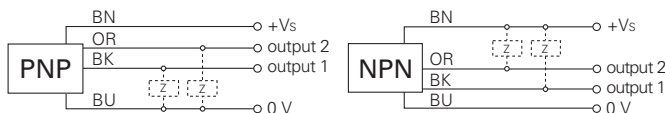

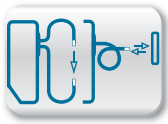

S_b = 320 mm
T_w = 90 mm

- sensitivity adjustable via Teach-in
- integrated alarm output
- protection class IP 65

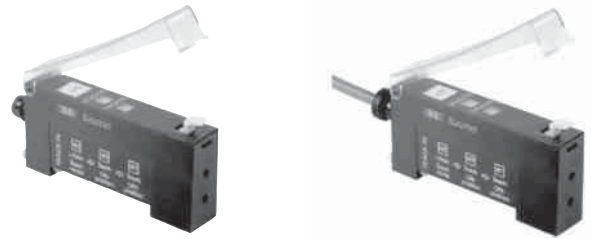

general data

| | |
|--|---------------------|
| actual range S _b (FSE 200C1002) | 320 mm |
| sensing distance T _w (FUE 200C1003) | 90 mm |
| light source | pulsed red LED |
| light indicator | LED green |
| alignment / soiled lens indicator | LED green, flashing |
| output indicator | LED yellow |
| adjustment | Teach-in |
| wave length | 660 nm |

electrical data

| | |
|--------------------------------------|---------------------------------|
| response time / release time | < 1 ms |
| voltage supply range +V _s | 10 ... 30 VDC |
| current consumption max. (no load) | 46 mA |
| current consumption typ. | 36 mA |
| voltage drop V _d | < 1,8 VDC |
| output function | light / dark operate switchable |
| output current | < 100 mA |
| short circuit protection | yes |
| reverse polarity protection | yes |

mechanical data

| | |
|------------------|-------------|
| width / diameter | 12 mm |
| height / length | 33,2 mm |
| depth | 60 mm |
| type | rectangular |
| housing material | PBT / PC |

ambient conditions

| | |
|-----------------------|----------------|
| operating temperature | -25 ... +55 °C |
| protection class | IP 65 |

connectors

| | | |
|--------------|-------|--------------|
| ESG 32AH0200 | 4 pin | 2 m straight |
| ESW 31AH0200 | 4 pin | 2 m angular |

additional cable connectors and field wireable connectors, see accessories

dimension drawings

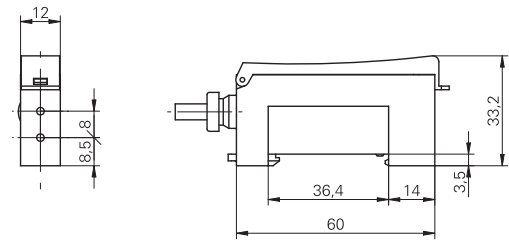
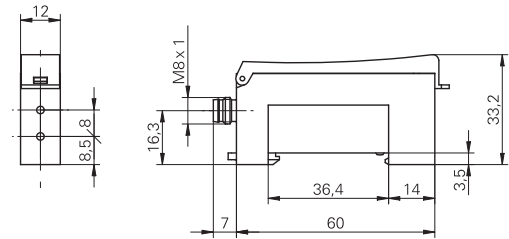

connection diagrams

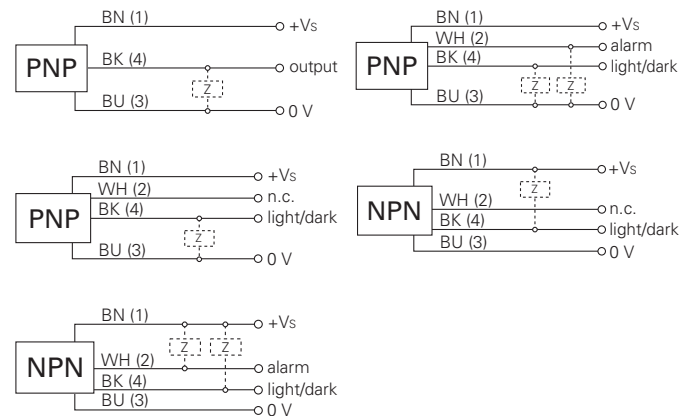

| order reference | min. output pulse length | output circuit | connection types | version |
|-------------------|--------------------------|----------------|--------------------|-------------------------|
| FVDK 12N6101/S35A | - | NPN | connector M8 4 pin | - |
| FVDK 12N6401/S35A | - | NPN | connector M8 4 pin | integrated alarm output |
| FVDK 12P6101 | - | PNP | cable, 2 m | - |
| FVDK 12P6101/S35A | - | PNP | connector M8 4 pin | - |
| FVDK 12P6401 | - | PNP | cable, 2 m | integrated alarm output |
| FVDK 12P6401/S35A | - | PNP | connector M8 4 pin | integrated alarm output |
| FVDK 12P6501/S35A | 40 ms | PNP | connector M8 4 pin | integrated alarm output |

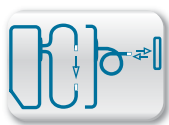

S_b = 140 mm

- short response time 50 μs
- fast version < 0,05 ms
- integrated alarm output



general data

| | |
|--|---------------------|
| version | fast version |
| actual range S _b (FSE 200C1002) | 140 mm |
| sensing distance T _w (FUE 200C1003) | 40 mm |
| light source | pulsed red LED |
| light indicator | LED green |
| alignment / soiled lens indicator | LED green, flashing |
| output indicator | LED yellow |
| adjustment | Teach-in |
| wave length | 660 nm |

electrical data

| | |
|--------------------------------------|---------------------------------|
| response time / release time | < 0,05 ms |
| voltage supply range +V _s | 10 ... 30 VDC |
| current consumption max. (no load) | 45 mA |
| current consumption typ. | 40 mA |
| voltage drop V _d | < 1,8 VDC |
| output function | light / dark operate switchable |
| output circuit | PNP |
| output current | < 100 mA |
| short circuit protection | yes |
| reverse polarity protection | yes |

mechanical data

| | |
|------------------|--------------------|
| width / diameter | 12 mm |
| height / length | 33,2 mm |
| depth | 60 mm |
| type | rectangular |
| housing material | PBT / PC |
| connection types | connector M8 4 pin |

ambient conditions

| | |
|-----------------------|----------------|
| operating temperature | -25 ... +55 °C |
| protection class | IP 65 |

connectors

| | | |
|--------------|-------|--------------|
| ESG 32AH0200 | 4 pin | 2 m straight |
| ESW 31AH0200 | 4 pin | 2 m angular |

additional cable connectors and field wireable connectors, see accessories

order reference

FVDK 12P6410/S35A

dimension drawing

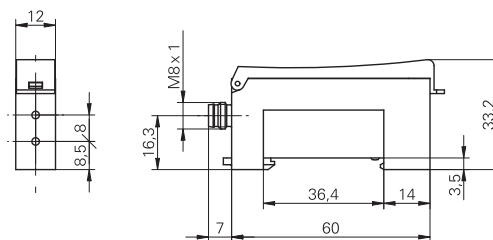

connection diagram

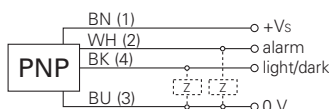

FVDK 12 S_b = 140 mm

Plastic fiber optic sensors

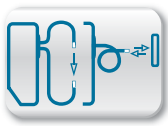

S_b = 320 mm
T_w = 90 mm

- 2 sensors in one housing
- sensitivity adjustable via Teach-in
- optional logical output operation



general data

| | |
|--|---------------------|
| actual range S _b (FSE 200C1002) | 320 mm |
| sensing distance T _w (FUE 200C1003) | 90 mm |
| light source | pulsed red LED |
| light indicator | LED green |
| alignment / soiled lens indicator | LED green, flashing |
| output indicator | LED yellow |
| wave length | 660 nm |
| suppression of reciprocal influence | yes |

electrical data

| | |
|--------------------------------------|---------------------------------|
| response time / release time | < 1 ms |
| voltage supply range +V _s | 10 ... 30 VDC |
| current consumption max. (no load) | 68 mA |
| current consumption typ. | 50 mA |
| voltage drop V _d | < 1,8 VDC |
| output function | light / dark operate switchable |
| output circuit | PNP |
| output current | < 100 mA |
| short circuit protection | yes |
| reverse polarity protection | yes |

mechanical data

| | |
|------------------|-------------|
| width / diameter | 22 mm |
| height / length | 33,2 mm |
| depth | 60 mm |
| type | rectangular |
| housing material | PBT / PC |

ambient conditions

| | |
|-----------------------|----------------|
| operating temperature | -25 ... +55 °C |
| protection class | IP 65 |

connectors

| | | |
|----------|-------|--------------|
| ES 34CP2 | 5 pin | 2 m straight |
| ES 33CP2 | 5 pin | 2 m angular |

additional cable connectors and field wireable connectors, see accessories

dimension drawings

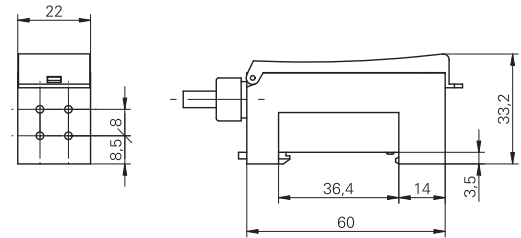
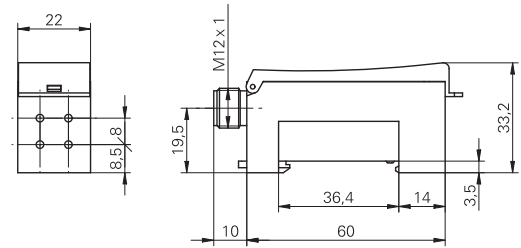

connection diagrams

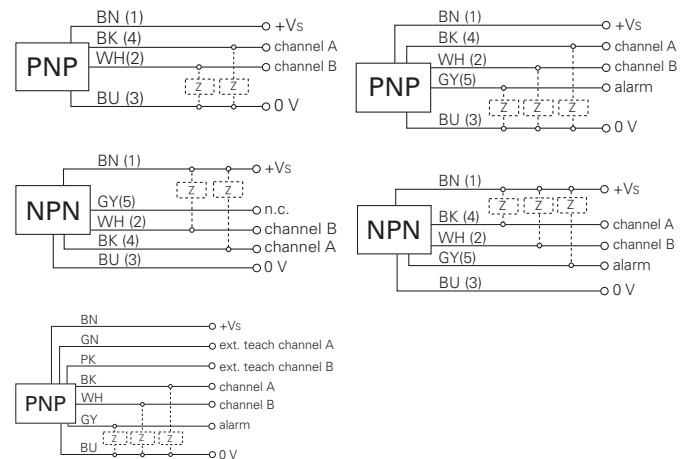

| order reference | adjustment | min. output pulse length | connection types | version |
|-------------------|-----------------------------|--------------------------|---------------------|-------------------------|
| FVDK 22P6101 | Teach-in | - | cable, 2 m | - |
| FVDK 22P6101/S14C | Teach-in | - | connector M12 5 pin | - |
| FVDK 22P6401 | Teach-in | - | cable, 2 m | integrated alarm output |
| FVDK 22P6401/S14C | Teach-in | - | connector M12 5 pin | integrated alarm output |
| FVDK 22P6420 | Teach-in: button / external | - | cable, 2 m | integrated alarm output |
| FVDK 22P6501/S14C | Teach-in | 40 ms | connector M12 5 pin | integrated alarm output |

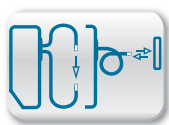

Sb = 90 mm
Tw = 25 mm

- analog output 1 ... 5 VDC
- adjustable resolution



general data

| | |
|------------------------------------|--------------------------|
| actual range Sb (FSE 200C1002) | 90 mm |
| sensing distance Tw (FUE 200C1003) | 25 mm |
| light source | pulsed red LED |
| alignment / soiled lens indicator | LED red |
| output indicator | LED green |
| adjustment | potentiometer |
| resolution | 0,3 ... 6 % (Full Scale) |
| wave length | 680 nm |

electrical data

| | |
|------------------------------------|--------------------------|
| response time / release time | 1 ... 50 ms (adjustable) |
| voltage supply range +Vs | 10,8 ... 26,4 VDC |
| current consumption max. (no load) | 40 mA |
| output circuit | analog 1 ... 5 VDC |
| load resistance | > 10 kOhm |
| short circuit protection | yes |
| reverse polarity protection | yes |

mechanical data

| | |
|------------------|-------------------|
| width / diameter | 10 mm |
| height / length | 29,7 mm |
| depth | 60 mm |
| type | rectangular |
| housing material | polycarbonate/ABS |
| connection types | cable, 2 m |

ambient conditions

| | |
|-----------------------|----------------|
| operating temperature | -20 ... +60 °C |
| protection class | IP 40 |

order reference

FWDK 10U84Y0

dimension drawing

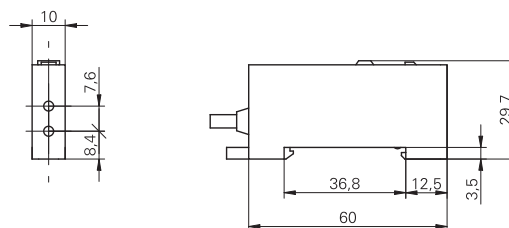

connection diagram

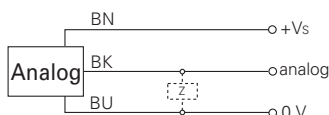

FWDK 84 Sb = 90 mm, Tw = 25 mm

Plastic fiber optic sensors

Plastic fiber optics Reflective types

Series 10

Series 82/81/83

Series 84

Legend of operating modes

HS High Speed

FT fast

nL Standard

HP High Sensitivity

Series 12/22

Series 66

Series 67

| Model Features | Shape R = min. bending radius | Part number | TW = sensing distance [mm] |
|--|--|---------------------|----------------------------|
| Standard M6 Sensing head: brass | R = 15 mm Operating temperature: -30...+70 °C | FUE 200C1003 | |
| Standard ø 6 mm Smooth sensing head without thread Sensing head: aluminum | R = 15 mm Operating temperature: -30...+70 °C | FUE 200C2003 | |
| Standard M4 Sensing head: brass | R = 8 mm Operating temperature: -30...+70 °C | FUE 200C1004 | |
| Standard ø 4 mm Smooth sensing head without thread Sensing head: aluminum | R = 8 mm Operating temperature: -30...+70 °C | FUE 200C2004 | |
| Standard M3 Sensing head: stainless steel | R = 15 mm Operating temperature: -30...+70 °C | FUE 200D1Y00 | |
| Standard ø 3 mm Smooth sensing head without thread Sensing head: stainless steel | R = 15 mm Operating temperature: -30...+70 °C | FUE 200D2Y00 | |
| Long-distance M6 Longer sensing distance than with the standard version. With integrated lens. Sensing head: stainless steel | R = 20 mm Operating temperature: -30...+70 °C | FLE 200C1Y00 | |
| Long-distance M4 Longer sensing distance than with the standard version. With integrated lens. Sensing head: stainless steel | R = 15 mm Operating temperature: -30...+70 °C | FLE 200D1Y00 | |
| Ultra flexible M6 Ultra flexible type with bending radius of 2 mm Sensing head: stainless steel | R = 2 mm Operating temperature: -30...+70 °C | FUE 200E1Y00 | |

Plastic fiber optics Reflective types

Series 10

82 81 83
Series 82/81/83

Series 84

Legend of operating modes
HS High Speed
FT fast
nL Standard
HP High Sensitivity

Series 12/22

FT nL
Series 66

HS nL HP
Series 67

| Model Features | Shape R = min. bending radius | Part number | TW = sensing distance [mm] |
|---|----------------------------------|---------------------|---|
| Ultra flexible, pliable M3 Highly flexible, extremely pliable fiber with a min. bending radius of 4 mm. Suitable for drag chains. Sensing head: stainless steel | | FUE 200F1Y00 | □ 6 ■ 6/12/20 - □ 15 ■ 10/18 ■ 5/40/50 |
| Coaxial M6 Suitable for positioning Sensing head: stainless steel | | FCE 200C1Y00 | □ 45 ■ 30/70/120 ■ 25 □ 90 ■ 65/110 ■ 33/260/300 |
| Coaxial M4 Suitable for positioning Sensing head: stainless steel | | FCE 200C1Y01 | □ 16 ■ 12/20/40 ■ 8 □ 25 ■ 20/35 ■ 12/80/110 |
| Coaxial M3 Suitable for positioning. Spot sizes of 0.1 mm possible with doubling lens (see fiber optic accessories). Sensing head: stainless steel | | FCE 200D1Y00 | □ 10 ■ 8/15/30 ■ 5 □ 20 ■ 16/28 ■ 8/65/95 |
| Coaxial M3 Suitable for positioning. Spot sizes of 0.1 mm possible with doubling lens (see fiber optic accessories). Sensing head: stainless steel | | FCE 200D1Y01 | □ 10 ■ 8/15/30 ■ 5 □ 20 ■ 16/28 ■ 8/65/95 |
| Coaxial M3 Suitable for positioning. Spot sizes of 0.1 mm possible with doubling lens (see fiber optic accessories). Sensing head: stainless steel | | FCE 050C1Y10 | □ 10 ■ 8/15/30 ■ 5 □ 20 ■ 13/22 ■ 6/50/70 |
| Coaxial, ultra flexible M3 Ultra flexible. Suitable for positioning. Spot sizes of 0.1 mm possible with doubling lens (see fiber optic accessories). Sensing head: stainless steel | | FCE 200E1Y00 | □ 8 ■ 6/13/26 ■ 4 □ 18 ■ 13/22 ■ 6/50/70 |
| Side view ø 2 mm Smaller outside diameter, suitable for constrained conditions. Sensing head: stainless steel | | FUE 200C4Y00 | □ 5 ■ 3/9/14 - □ 10 ■ 8/13 ■ 4/30/45 |
| Smaller sensing head, flexible Chrome nickel sensing head which can be bent once. R > 7.5 mm. Other sensing head lengths on request. Sensing head: chrome nickel/brass | | FUE 200C1012 | □ 18 ■ 12/25/45 ■ 10 □ 35 ■ 26/45 ■ 12/100/120 |

Reflective types

Plastic fiber optics

Plastic fiber optics Reflective types

Series 10

Series 82/81/83

Series 84

Legend of operating modes
 HS High Speed
 FT fast
 nL Standard
 HP High Sensitivity

Series 12/22

Series 66

Series 67

| Model Features | Shape R = min. bending radius | Part number | TW = sensing distance [mm] |
|---|----------------------------------|--------------|--|
| Small sensing head ø 1,5 mm Highly flexible, extremely pliable fiber with a min. bending radius of 4 mm. Suitable for drag chains. Sensing head: stainless steel | | FUE 100E2Y00 | □ 6 ■ 6/12/20 - □ 15 ■ 10/18 ■ 5/40/50 |
| Small sensing head ø 1,5 mm Suitable for small spaces Sensing head: stainless steel | | FUE 200C2Y00 | □ 18 ■ 12/25/45 ■ 9 □ 35 ■ 26/45 ■ 12/90/120 |
| Small sensing head ø 0,82 mm Suitable for small spaces Sensing head: stainless steel | | FUE 050C2Y10 | □ 3 ■ 2/5/12 - □ 8 ■ 5/9 ■ 3/20/30 |
| Parallel beam M5 Sharp beam eliminates the influence of reflections from periphery. Spot size 3 mm at a distance of 20 mm. Sensing head: stainl. steel / Al | | FKE 200D1Y00 | □ 10 ■ 8/15/30 ■ 5 □ 20 ■ 13/22 ■ 8/60/70 |
| Focus Suitable for detection of highly transparent objects (glass, foils) Sensing distance: 2,5 mm ±0,5 Sensing head: aluminum | | FFE 200D6Y00 | □ 2.5 ■ 2.5 (Series 81/83) - □ 2.5 ■ 2.5 ■ 2.5 |
| Array Reliably detects small, thin or vibrating workpieces in an area of 10,85 mm. Sensing head: brass, Ni plated | | FUE 200C6Y00 | □ 45 ■ 30/70/120 ■ 20 □ 80 ■ 50/85 ■ 30/200/270 |
| Heat resistant M6 Heat resistant up to +105 °C Sensing head: stainless steel | | FUA 200C1Y00 | □ 40 ■ 25/50/100 ■ 18 □ 70 ■ 47/80 ■ 27/200/220 |
| Heat and cold resistant M6 Continuous use from -60 °C up to +150 °C Sensing head: stainless steel | | FUB 200C1Y00 | □ 45 ■ 40/80/160 ■ 28 □ 110 ■ 75/130 ■ 42/300/400 |
| | | | |

Reflective types

Plastic fiber optics

Plastic fiber optics Reflective types

Series 10

Series 82/81/83

Series 84

Legend of operating modes
HS High Speed
FT fast
nL Standard
HP High Sensitivity

Series 12/22

Series 66

Series 67

| Model Features | Shape R = min. bending radius | Part number | TW = sensing distance [mm] |
|--|--|---|----------------------------|
| <p>Chemical proof</p> <p>For use in chemically aggressive environments. Fiber optic sensor is fully sheathed in PFA.</p> <p>Sensing head: stainless steel / PFA</p> | <p>R = 80 mm Operating temperature: -30...+70 °C</p> | <p>FUC 200C2Y00</p> | |
| <p>Level recognition</p> <p>Detection of diverse liquids. Resistant to chemicals due to PFA sheath. Heat resistant up to +105 °C</p> <p>Sensing head: PFA</p> | <p>R = 15 mm / 30 mm tip to 40 mm length Operating temperature: -30...+105 °C</p> | <p>FUL 200D2Y00</p> <p>Switches when immersed in liquid. Recommend fiber optic sensor Series 67. Do not use with Series 82!</p> <p>More information about liquid level recognition or leak detection, see chapter «level monitoring and leak detecting sensors».</p> | |
| <p>Leak monitoring</p> <p>Detects liquids escaping from tanks and trays. Resistant to chemicals due to PFA sheath.</p> <p>Sensing head: PFA</p> | <p>R = 20 mm Operating temperature: -30...+70 °C</p> | <p>FOC 500C6Y00</p> <p>Fiber optic sensor is mounted directly on the floor or a base and switches on contact with escaping liquids. Recommend fiber optic sensor Series 67. Do not use with Series 82!</p> <p>More information can be found in chapter «Level and leak sensors».</p> | |
| | | | |
| | | | |
| | | | |
| | | | |
| | | | |
| | | | |
| | | | |

Plastic fiber optics Through beam types

Series 10

Series 82/81/83

Series 84

Legend of operating modes

HS High Speed

FT fast

nL Standard

HP High Sensitivity

Series 12/22

Series 66

Series 67

| Model Features | Shape R = min. bending radius | Part number | Sb = actual range [mm] |
|---|--|---------------------|------------------------|
| Standard M4 Sensing head: brass | R = 15 mm Operating temperature: -30...+70 °C | FSE 200C1002 | |
| Standard M4 Shorter version Sensing head: stainless steel | R = 20 mm Operating temperature: -30...+70 °C | FSE 200C1Y00 | |
| Standard ø 4 mm Smooth sensing head without thread Sensing head: aluminum | R = 15 mm Operating temperature: -30...+70 °C | FSE 200C2002 | |
| Standard M3 Sensing head: brass | R = 8 mm Operating temperature: -30...+70 °C | FSE 200C1004 | |
| Standard ø 3 mm Smooth sensing head without thread Sensing head: aluminum | R = 8 mm Operating temperature: -30...+70 °C | FSE 200C2004 | |
| Standard ø 3 mm Shorter version Smooth sensing head without thread Sensing head: stainless steel | R = 20 mm Operating temperature: -30...+70 °C | FSE 200C2Y00 | |
| Long distance M4 Twice the range of an M4 standard fiber optic sensor with integrated lens Sensing head: stainless steel | R = 20 mm Operating temperature: -30...+70 °C | FWE 200C1Y00 | |
| Long distance ø 3 mm Smooth sensing head without thread, with integrated lens Sensing head: stainless steel | R = 20 mm Operating temperature: -30...+70 °C | FWE 200C2Y00 | |
| Ultra flexible M4 Ultra flexible type with bending radius of 2 mm Sensing head: stainless steel | R = 2 mm Operating temperature: -30...+70 °C | FSE 200E1Y00 | |

Plastic fiber optics Through beam types

Series 10

Series 82/81/83

Series 84

Legend of operating modes
 HS High Speed
 FT fast
 nL Standard
 HP High Sensitivity

Series 12/22

Series 66

Series 67

| Model Features | Shape R = min. bending radius | Part number | Sb = actual range [mm] |
|---|---|--------------|------------------------|
| Ultra flexible M3 Highly flexible fiber with a min. bending radius of 1 mm Sensing head: stainless steel | <p>R = 1 mm Operating temperature: -30...+70 °C</p> | FSE 200F1Y00 | |
| Highly flexible, pliable M3 Highly flexible, extremely pliable fiber with a min. bending radius of 4 mm. Suitable for drag chains. Sensing head: stainless steel | <p>R = 4 mm Operating temperature: -30...+70 °C</p> | FSE 200D1Y50 | |
| Ultra flexible, 3 mm Highly flexible fiber with a min. bending radius of 2 mm Sensing head: stainless steel | <p>R = 2 mm Operating temperature: -30...+70 °C</p> | FSE 200E2Y00 | |
| Side view M4 Sensing head: brass | <p>R = 15 mm Operating temp.: -30...+70 °C</p> | FSE 200C4002 | |
| Side view ø 4 mm Smooth sensing head without thread Sensing head: aluminum | <p>R = 15 mm Operating temp.: -30...+70 °C</p> | FSE 200C4001 | |
| Side view ø 1 mm Small sensing head Small target object detection Sensing head: stainless steel | <p>R = 15 mm Operating temperature: -30...+70 °C</p> | FSE 200D4Y00 | |
| Side light exit, small sensing head 1 mm diameter, highly flexible Small target object detection Sensing head: stainless steel | <p>R = 1 mm Operating temperature: -30...+70 °C</p> | FSE 200F4Y00 | |
| Small sensing head ø 1,5 mm Highly flexible, extremely pliable fiber with a min. bending radius of 4 mm. Suitable for drag chains. Sensing head: stainless steel | <p>R = 4 mm Operating temperature: -30...+70 °C</p> | FSE 200D2Y00 | |
| Small sensing head ø 0,5 mm Detection of very small objects. Light spot diameter 0,25 mm Sensing head: stainless steel | <p>R = 15 mm Operating temperature: -30...+70 °C</p> | FSE 200D2Y50 | |

Plastic fiber optics Through beam types

Series 10

Series 82/81/83

Series 84

Legend of operating modes

HS High Speed

FT fast

nL Standard

HP High Sensitivity

Series 12/22

Series 66

Series 67

| Model Features | Shape R = min. bending radius | Part number | Sb = actual range [mm] |
|---|---|---|------------------------|
| Parallel beam M4, exit angle ± 2° The small beam angle makes a precise, virtually parallel light beam. Sensing head: stainless steel | <p>R = 20 mm Operating temperature: -30...+70 °C</p> | FPE 200C1Y00 | |
| Parallel beam M4, exit angle ± 1° The small beam angle makes a precise, virtually parallel light beam. Sensing head: stainless steel | <p>R = 15 mm Operating temperature: -30...+70 °C</p> | FPE 200D1Y00 | |
| Parallel beam, side view ± 2° The small beam angle makes a precise, virtually parallel light beam. Sensing head: stainless steel | <p>R = 30 mm Operating temperature: -30...+70 °C</p> | FPE 200C4Y00 | |
| Flat sensing head, highly flexible fiber Can be mounted directly on a plate. Highly flexible fiber with a min. bending radius of 1 mm. Sensing head: brass, Ni plated | <p>R = 1 mm Operating temperature: -30...+70 °C</p> | FSE 200F6Y00 | |
| Flat sensing head, highly flexible fiber Highly flexible fiber with a min. bending radius of 1 mm. Sensing head: POM | <p>R = 1 mm Operating temperature: -30...+70 °C</p> | FSE 100F6Y01 | |
| Array (fine light barrier) Reliably detects small, thin or vibrating workpieces in a light curtain of 5,25 mm. Sensing head: brass, Ni plated | <p>R = 4 mm Operating temperature: -30...+70 °C</p> | FSE 200C6Y00 | |
| Array (fine light barrier) Reliably detects small, thin or vibrating workpieces in a light curtain: of 10,5, 15,75 and 21 mm. Sensing head: aluminum | <p>R = 4 mm Operating temperature: -30...+70 °C</p> | 1) FSE 200C6Y01 2) FSE 200C6Y15 3) FSE 200C6Y02 | |
| Small, bendable sensing head Chrome nickel sensing head which can be bent once. R > 7.5 mm. Other sensing head lengths on request. Sensing head: chrome nickel / brass | <p>R = 8 mm</p> | FSE 200C1013 | |

Through beam types

Plastic fiber optics

Plastic fiber optics Through beam types

Series 10

Series 82/81/83

Series 84

Legend of operating modes
HS High Speed
FT fast
nL Standard
HP High Sensitivity

Series 12/22

Series 66

Series 67

| Model Features | Shape R = min. bending radius | Part number | Sb = actual range [mm] |
|--|--|--------------|---|
| Heat resistant M4 Heat resistant up to +105 °C Sensing head: stainless steel | <p>R = 25 mm Operating temperature: -30...+105 °C</p> | FSA 200C1Y00 | |
| Heat and cold resistant M4 Continuous use from -60 °C up to +150 °C Sensing head: stainless steel | <p>R = 35 mm Operating temperature: -60...+150 °C</p> | FSB 200C1Y00 | |
| Heat and cold resistant M4 Continuous use from -60 °C up to +350 °C (Glass fiber optics) Sensing head: stainless steel | <p>R = 25 mm Operating temperature: -60...+350 °C</p> | FSG 200C1Y00 | |
| Chemical and oil proof For use in chemically aggressive environments. Fiber optic sensor is fully sheathed in PFA. Sensing head: stainless steel / PFA | <p>R = 80 mm Operating temperature: -30...+70 °C</p> | FSC 200C2Y00 | |
| Chemical and oil proof For use in chemically aggressive environments. Fiber optic sensor is fully sheathed in PFA. Sensing head: stainless steel / PFA | <p>R = 20 mm Operating temperature: -30...+70 °C</p> | FLC 200D2Y00 | |
| Chemical and oil proof, side view For use in chemically aggressive environments. Fiber optic sensor is fully sheathed in PFA. Sensing head: stainless steel / PFA | <p>R = 20 mm Operating temperature: -30...+70 °C</p> | FSC 200C4Y00 | |
| Contact-free level detection Detects liquids in (semi-)transparent stand pipes/hoses with 3-13 mm diameter. Sensing head: PFI / PC | <p>R = 4 mm Operating temperature: -30...+70 °C</p> | FSL 500C6Y00 | Fiber optic sensor is mounted directly on the hose/stand pipe and switches on contact with escaping liquids. Recommend fiber optic sensor Series 69 and 67. Do not use with Series 82! More information can be found in chapter «Level and leak sensors». |
| | | | |
| | | | |

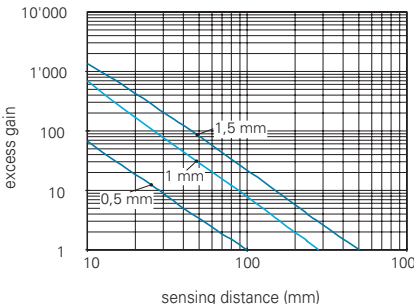
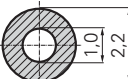
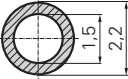

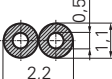
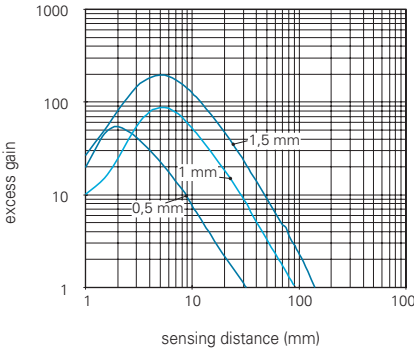
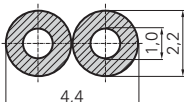
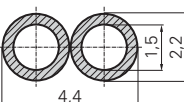

| through-beam types | fiber ø | fiber mm ² | min. bending radius | part nr. ¹⁾ | excess gain curve (2 m cut fiber) |
|--|---------|-----------------------|---------------------|------------------------|---|
|  | 0,5 mm | ≈ 0,2 mm ² | 8 mm | 10114158 |  <p>reduction of sensing distance: 4 % per meter (valid up to 10 m)</p> |
|  | 1 mm | ≈ 0,8 mm ² | 15 mm | 10114157 | |
|  | 1,5 mm | ≈ 1,8 mm ² | 25 mm | 10123729 | |

Highly flexible version on demand.

| reflective types | fiber ø | fiber mm ² | min. bending radius | part nr. ¹⁾ | excess gain curve (2 m cut fiber) |
|---|------------|---------------------------|---------------------|------------------------|---|
|  | 2 x 0,5 mm | ≈ 2 x 0,2 mm ² | 8 mm | 10114594 |  <p>reduction of sensing distance: 4 % per meter (valid up to 10 m)</p> |
|  | 2 x 1 mm | ≈ 2 x 0,8 mm ² | 15 mm | 10114595 | |
|  | 2 x 1,5 mm | ≈ 2 x 1,8 mm ² | 25 mm | 10124878 | |

Highly flexible version on demand.

¹⁾ order designation in meters

| product family | FZAM 18 | FZAM 18 | FZAM 18 | FZAM 30 | FVDM 15 |
|------------------------------|---|---|--|---|---|
| |  |  |  |  |  |
| width / diameter | 18 mm | 18 mm | 18 mm | 30 mm | 15 mm |
| actual range Sb | 310 mm | 800 mm | 800 mm | 600 mm 1400 mm | 1200 mm |
| sensing distance Tw | 60 mm | 150 mm | 150 mm | 110 mm 230 mm | 240 mm |
| response time / release time | < 0,5 ms | < 1 ms | < 1 ms | < 0,25 ms < 2,5 ms | < 0,1 ms < 1 ms |
| adjustment | potentiometer, 15 turn | potentiometer, 270° | Teach-in | potentiometer, 20 turn | potentiometer, 20 turn |
| NPN | ■ | ■ | ■ | ■ | ■ |
| PNP | ■ | ■ | ■ | ■ | ■ |
| cable | ■ | ■ | ■ | ■ | ■ |
| connector | | ■ | ■ | | ■ |
| housing material | metal | metal | metal | metal | metal |
| | | | | | |
| page | 336 | 337 | 338 | 339 | 344 |



General information

In contrast to plastic fiber optics, glass fiber optics contain hundreds of individual fibers. Each one conveys a part of the emitted light. Depending on the arrangement of the individual fibers, a homogeneous light spot or a line can be produced. Also, glass is a high-quality, durable material, which guarantees a long and constant service life. This is only one of the reasons that glass optical fibers are used in the telecommunications industry. The high heat resistance also allows fields of application which are difficult or completely impossible with other sensors.

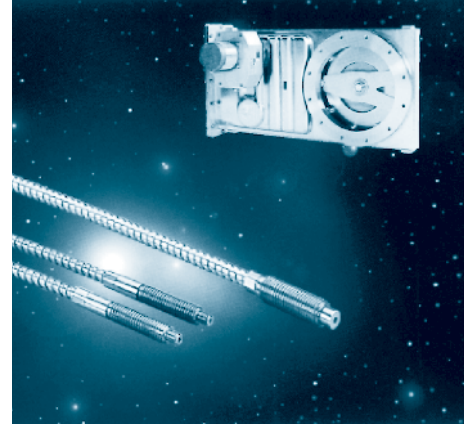

Typical applications

The wide range of sheath materials and sensing heads make it possible for you to adapt the sensors optimally to your machine concept. A way can always be found to fasten the small fiber optic heads. Due to the different available lengths, the fiber optic sensor can be placed individually at an optimum point.

- Metal-sheathed optical fibers can also be used under harsh conditions
- Detection, differentiation and positioning of different objects
- Monitoring of areas using fiber optic arrays with linear fiber arrangement
- Use at high, low or constantly fluctuating ambient temperatures
- Ranges of up to 1,4 m with fiber optic through beam types

Characteristics and advantages

Independent of the environment

As only light is conveyed, electromagnetic fields or high/low temperatures have no effect on the functional reliability.

(plastic-sheathed: -25 ... +70 °C)

(metal-sheathed: -25 ... +250 °C)

Rugged

Metal-sheathed optical fibers are protected against mechanical effects (chips etc). All fiber optic sensors are fitted with a rugged metal housing.

Stable operation

High-quality glass fibers ensure stable operation for a long period. All fiber optic sensors are equipped with high-power infrared light sources, which provide sufficient excess gain even with a certain degree of soiling.

Area monitoring

Fiber optic arrays with a linear fiber arrangement permit an area to be monitored or the detection of objects which are not precisely conveyed.

Optimum installation

Apart from the common threaded types, fiber optic sensors with smooth sleeves or side light exit are available.

Fast processes

Fiber optic sensors with response times of only 50 microseconds permit the detection of objects even in very fast processes.



Technology and operation

By exploiting the so-called total reflection, it is possible to convey light in a medium such as glass without great loss.

Explanation of total reflection

When light waves reflect on a barrier layer between two media with different optical densities, they do not simply carry on in a straight line. When they penetrate from an optically denser medium (e.g. glass fiber core) into an optically thinner medium (e.g. glass sheath), there is a smaller angle, the critical angle, under which total reflection occurs. The light wave is reflected back and remains in the optically denser medium.

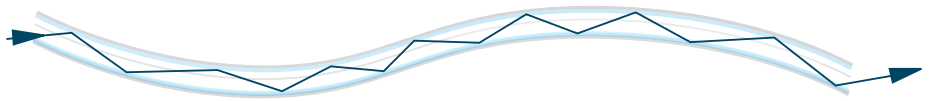

The glass sheath coating the core fiber is decisive for the transmission of light waves almost completely without loss. This ensures an optically consistent density of the sheath and the core and thereby permits a practically constant number of total reflections. This also occurs when the optical fiber is slightly bent. If there would be no core sheath, it would be highly decisive for the total reflection whether the optical fiber is used in an air medium or, for example, water. The critical angle would then change decisively, which could permit an undesired escape of light under certain circumstances.

In the sensing principle, fiber optic solutions are based on intensity differences. With fiber optic through beam types, an object breaking the light beam between the emitter and receiver is detected. With the fiber optic reflective types, the amount of light reflected by an object is evaluated.

For more information, see the section on plastic fiber optics in this chapter.

Mounting and adjustment

Fiber optics series 15

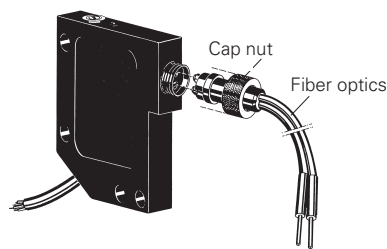

The cap nut to fasten the fiber optics is supplied with every order.

If damaged or lost, the cap nut can be ordered under the following number:

Cap nut 10103230

Fiber optics series 18



The adjusting plate and cap nut are supplied with every order.

If damaged or lost, they can be ordered under the following part numbers:

Adjusting plate 10101958
Cap nut 10101480

Fiber optics series 30

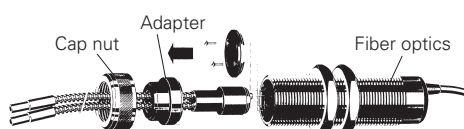

The adapter and the cap nut must be ordered as accessories with every order.

Adapter 10102757
Cap nut 10102801

For installation of the fiber optics, the cover must be removed.

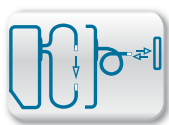

Sb = 310 mm
Tw = 60 mm

- sensitivity adjustable via potentiometer (axial)
- rugged metal housing
- infrared light source

general data

| | |
|-------------------------------------|------------------------|
| actual range Sb | 310 mm |
| sensing distance Tw | 60 mm |
| light source | pulsed infrared diode |
| light indicator | LED yellow |
| alignment / soiled lens indicator | LED, flashing |
| adjustment | potentiometer, 15 turn |
| wave length | 880 nm |
| suppression of reciprocal influence | yes |

electrical data

| | |
|------------------------------------|---------------|
| response time / release time | < 0,5 ms |
| voltage supply range +Vs | 10 ... 30 VDC |
| current consumption max. (no load) | 45 mA |
| current consumption typ. | 30 mA |
| voltage drop Vd | < 1,8 VDC |
| output function | light operate |
| output current | < 200 mA |
| short circuit protection | yes |
| reverse polarity protection | yes |

mechanical data

| | |
|------------------|--------------------------|
| width / diameter | 18 mm |
| height / length | 50 mm |
| type | cylindrical threaded |
| housing material | brass nickel plated / PC |
| connection types | cable 3 pin, 2 m |

ambient conditions

| | |
|-----------------------|----------------|
| operating temperature | -25 ... +55 °C |
| protection class | IP 65 |

accessories

| | |
|-----------------------|----------|
| SENSOFIX mounting kit | 10151658 |
| adjusting plate | 10101958 |
| cap nut | 10101480 |

for details, see accessories section

remarks

cap nut and adjusting plate are included with fibre



dimension drawing

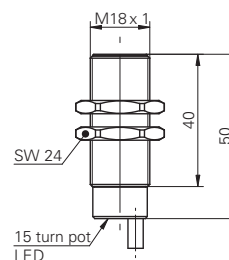

connection diagrams

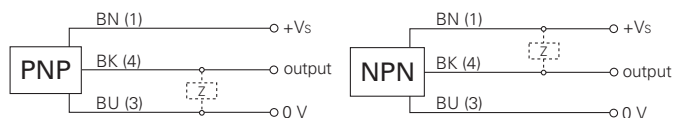

order reference

output circuit

| | |
|--------------|-----|
| FZAM 18N1155 | NPN |
| FZAM 18P1155 | PNP |

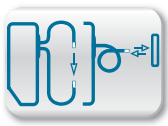

Sb = 800 mm
Tw = 150 mm

- sensitivity adjustable via potentiometer (radial)
- rugged metal housing
- infrared light source



general data

| | |
|-------------------------------------|-----------------------|
| actual range Sb | 800 mm |
| sensing distance Tw | 150 mm |
| light source | pulsed infrared diode |
| light indicator | LED yellow |
| alignment / soiled lens indicator | LED, flashing |
| adjustment | potentiometer, 270° |
| wave length | 880 nm |
| suppression of reciprocal influence | yes |

electrical data

| | |
|------------------------------------|---------------|
| response time / release time | < 1 ms |
| voltage supply range +Vs | 10 ... 30 VDC |
| current consumption max. (no load) | 45 mA |
| current consumption typ. | 30 mA |
| voltage drop Vd | < 1,8 VDC |
| output function | light operate |
| output current | < 200 mA |
| short circuit protection | yes |
| reverse polarity protection | yes |

mechanical data

| | |
|------------------|--------------------------|
| width / diameter | 18 mm |
| type | cylindrical threaded |
| housing material | brass nickel plated / PC |

ambient conditions

| | |
|-----------------------|----------------|
| operating temperature | -25 ... +55 °C |
| protection class | IP 67 |

connectors

| | | |
|--|-------|--------------|
| ESG 34AH0200 | 4 pin | 2 m straight |
| ESW 33AH0200 | 4 pin | 2 m angular |
| additional cable connectors and field wireable connectors, see accessories | | |

accessories

| | |
|--------------------------------------|----------|
| SENSOFIX mounting kit | 10151658 |
| adjusting plate | 10101958 |
| cap nut | 10101480 |
| for details, see accessories section | |

remarks

cap nut and adjusting plate are included with fibre

dimension drawings

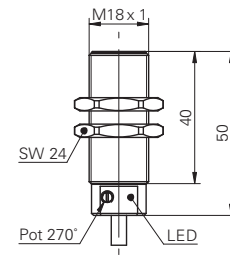
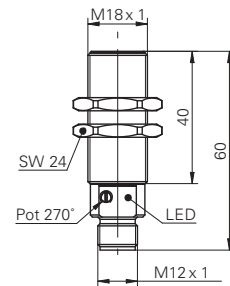

connection diagrams

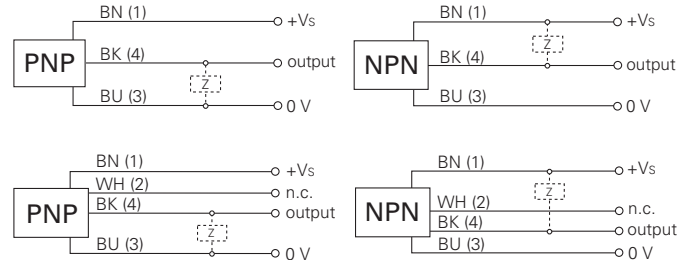

| order reference | height / length | output circuit | connection types |
|------------------|-----------------|----------------|---------------------|
| FZAM 18N1150 | 50 mm | NPN | cable 3 pin, 2 m |
| FZAM 18N1150/S14 | 60 mm | NPN | connector M12 4 pin |
| FZAM 18P1150 | 50 mm | PNP | cable 3 pin, 2 m |
| FZAM 18P1150/S14 | 60 mm | PNP | connector M12 4 pin |

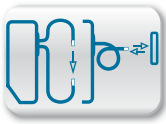

S_b = 800 mm
Tw = 150 mm

- sensitivity adjustable via Teach-in
- light / dark operation programmable
- rugged metal housing

general data

| | |
|-------------------------------------|-----------------------|
| actual range S _b | 800 mm |
| sensing distance Tw | 150 mm |
| light source | pulsed infrared diode |
| light indicator | LED green |
| alignment / soiled lens indicator | LED green, flashing |
| output indicator | LED yellow |
| adjustment | Teach-in |
| wave length | 880 nm |
| suppression of reciprocal influence | yes |

electrical data

| | |
|------------------------------------|---------------------------------|
| response time / release time | < 1 ms |
| voltage supply range +Vs | 10 ... 30 VDC |
| current consumption max. (no load) | 55 mA |
| current consumption typ. | 40 mA |
| voltage drop V _d | < 1,8 VDC |
| output function | light / dark operate switchable |
| output current | < 200 mA |
| short circuit protection | yes |
| reverse polarity protection | yes |

mechanical data

| | |
|------------------|--------------------------|
| width / diameter | 18 mm |
| type | cylindrical threaded |
| housing material | brass nickel plated / PC |

ambient conditions

| | |
|-----------------------|----------------|
| operating temperature | -25 ... +55 °C |
| protection class | IP 67 |

connectors

| | | |
|--|-------|--------------|
| ESG 34AH0200 | 4 pin | 2 m straight |
| ESW 33AH0200 | 4 pin | 2 m angular |
| additional cable connectors and field wireable connectors, see accessories | | |

accessories

| | |
|--------------------------------------|----------|
| SENSOFIX mounting kit | 10151658 |
| adjusting plate | 10101958 |
| cap nut | 10101480 |
| for details, see accessories section | |

remarks

cap nut and adjusting plate are included with fibre



dimension drawings

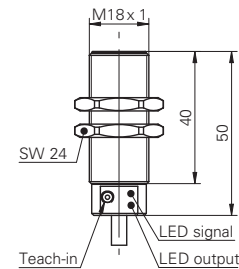
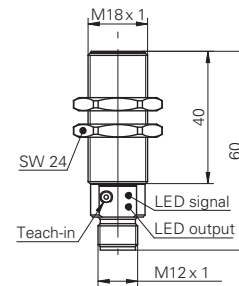

connection diagrams



| order reference | height / length | output circuit | connection types |
|------------------|-----------------|----------------|---------------------|
| FZAM 18N6460 | 50 mm | NPN | cable 4 pin, 2 m |
| FZAM 18N6460/S14 | 60 mm | NPN | connector M12 4 pin |
| FZAM 18P6460 | 50 mm | PNP | cable 4 pin, 2 m |
| FZAM 18P6460/S14 | 60 mm | PNP | connector M12 4 pin |

FZAM 18 Sb = 800 mm, Tw = 150 mm

Glass fiber optic sensors

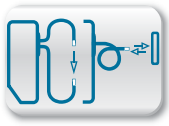

Sb = 1400 mm
Tw = 230 mm

- extended sensing distance
- fast version available
- rugged metal housing



general data

| | |
|-----------------------------------|------------------------|
| light source | pulsed infrared diode |
| light indicator | LED yellow |
| alignment / soiled lens indicator | LED, flashing |
| adjustment | potentiometer, 20 turn |
| wave length | 880 nm |

electrical data

| | |
|-----------------------------|----------------------|
| voltage supply range +Vs | 10 ... 30 VDC |
| voltage drop Vd | < 2,5 VDC |
| output function | light / dark operate |
| output current | < 100 mA |
| short circuit protection | yes |
| reverse polarity protection | yes |

mechanical data

| | |
|------------------|----------------------|
| width / diameter | 30 mm |
| height / length | 66 mm |
| type | cylindrical threaded |
| housing material | brass nickel plated |
| connection types | cable 4 pin, 2 m |

ambient conditions

| | |
|-----------------------|--------------|
| operating temperature | 0 ... +65 °C |
| protection class | IP 65 |

accessories

| | |
|--------------------------------------|----------|
| adapter | 10102757 |
| adapter (spec. for side view fibres) | 10106042 |
| cap nut | 10102801 |

for details, see accessories section

remarks

cap nut and adapter has to be ordered separately

dimension drawing

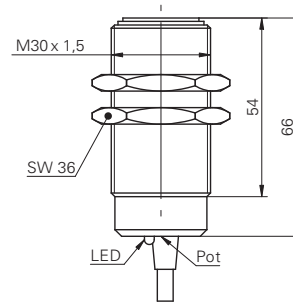

connection diagrams



| order reference | actual range Sb | sensing distance Tw | response time / release time | current consumption max. (no load) | current consumption typ. | output circuit |
|-----------------|-----------------|---------------------|------------------------------|------------------------------------|--------------------------|----------------|
| FZAM 30N5001 | 600 mm | 110 mm | < 0,25 ms | 40 mA | 30 mA | NPN |
| FZAM 30N5004 | 1400 mm | 230 mm | < 2,5 ms | 50 mA | 33 mA | NPN |
| FZAM 30P5001 | 600 mm | 110 mm | < 0,25 ms | 40 mA | 30 mA | PNP |
| FZAM 30P5004 | 1400 mm | 230 mm | < 2,5 ms | 50 mA | 33 mA | PNP |

Glass fiber optics for Series 18, 30

Reflective types

Series 18
20-turn pot.

Series 18
Side mounted pot.
Teach-in

Series 30
Fast version

Series 30
Extended Tw

| Fiber diameter 2 x 0,5 mm ² | | Part number | Tw = sensing distance [mm] |
|--|---|---|----------------------------|
| Sheath material: PVC ø 2,5 mm (FUE ...) | Sheath material: brass chromium plated ø 4 mm (FUF ...) | | |
| | * can not be bent | FUE 050A2004 FUF 050A2004 (length 50 cm) | 10 20 15 35 |
| | * can not be bent | FUE 100A2004 FUF 100A2004 (length 100 cm) | 5 20 15 30 |
| | * can not be bent | FUE 050A2003 FUF 050A2005 (length 50 cm) | 10 20 15 35 |
| | * can not be bent | FUE 100A2003 FUF 100A2005 (length 100 cm) | 5 20 15 30 |
| | * can not be bent | FUE 050A1003 FUF 050A1005 (length 50 cm) | 10 20 15 35 |
| | * can not be bent | FUE 100A1003 FUF 100A1005 (length 100 cm) | 5 20 15 30 |
| | | FUE 050A4004 FUF 050A4004 (length 50 cm) | 10 20 15 35 |
| | | FUE 100A4004 FUF 100A4004 (length 100 cm) | 5 20 15 30 |
| Fiber diameter 2 x 1 mm ² | | Part number | Tw = sensing distance [mm] |
| Sheath material: PUR ø 4,5 mm (FUE ...) | Sheath material: brass chromium plated ø 5 mm (FUF ...) | | |
| | | FUE 050A2002 FUF 050A2007 (length 50 cm) | 15 40 30 70 |
| | | FUE 100A2002 FUF 100A2007 (length 100 cm) | 15 40 30 60 |
| | | FUE 050A1002 FUF 050A1007 (length 50 cm) | 15 40 30 70 |
| | | FUE 100A1002 FUF 100A1007 (length 100 cm) | 15 40 30 60 |
| | | FUE 050A4005 FUF 050A4005 (length 50 cm) | 15 40 30 70 |
| | | FUE 100A4005 FUF 100A4005 (length 100 cm) | 15 40 30 60 |
| Fiber diameter 2 x 0,5 mm ² | | Part number | Tw = sensing distance [mm] |
| Sheath material: Chrome-nickel-steel ø 2 mm FUH 010A2002 | | | |
| | | FUH 010A2002 (length 10 cm) | 10 20 15 35 |

Glass fiber optics for Series 18, 30

Reflective types

Series 18
20-turn pot.

Series 18
Side mounted pot.
Teach-in

Series 30
Fast version

Series 30
Extended Tw

| Fiber diameter 2 x 2 mm ² | | Part number | Tw = sensing distance [mm] |
|---|---|---|----------------------------|
| Sheath material: PUR ø 4,5 mm (FUE ...) | Sheath material: brass chromium plated ø 5 mm (FUF ...) | | |
| | | FUE 050A2011 FUF 050A2011 (length 50 cm) | 35, 80, 60, 115 |
| | | FUE 100A2011 FUF 100A2011 (length 100 cm) | 35, 80, 60, 115 |
| | | FUE 050A1011 FUF 050A1011 (length 50 cm) | 35, 80, 60, 115 |
| | | FUE 100A1011 FUF 100A1011 (length 100 cm) | 35, 80, 60, 115 |
| | | FUE 050A4003 FUF 050A4003 (length 50 cm) | 35, 80, 60, 115 |
| | | FUE 100A4003 FUF 100A4003 (length 100 cm) | 35, 80, 60, 115 |
| Fiber diameter 2 x 3 mm ² | | Part number | Tw = sensing distance [mm] |
| Sheath material: PUR ø 6 mm (FUE ...) | Sheath material: brass chromium plated ø 6 mm (FUF ...) | | |
| | | FUE 050A2008 FUF 050A2003 (length 50 cm) | 60, 150, 100, 210 |
| | | FUE 100A2008 FUF 100A2003 (length 100 cm) | 55, 150, 100, 200 |
| | | FUE 050A1008 FUF 050A1003 (length 50 cm) | 60, 150, 100, 210 |
| | | FUE 100A1008 FUF 100A1003 (length 100 cm) | 55, 150, 100, 200 |
| | | FUE 050A3001 FUF 050A3001 (length 50 cm) | 60, 150, 100, 210 |
| | | FUE 100A3001 FUF 100A3001 (length 100 cm) | 55, 150, 100, 200 |
| Fiber diameter 2 x 4 mm ² | | Part number | Tw = sensing distance [mm] |
| Sheath material: PUR ø 6 mm (FUE ...) | Sheath material: brass chromium plated ø 6 mm (FUF ...) | | |
| | | FUE 050A2001 FUF 050A2001 (length 50 cm) | 60, 150, 110, 230 |
| | | FUE 100A2001 FUF 100A2001 (length 100 cm) | 60, 150, 100, 220 |
| | | FUE 050A1001 FUF 050A1001 (length 50 cm) | 60, 150, 110, 230 |
| | | FUE 100A1001 FUF 100A1001 (length 100 cm) | 60, 150, 100, 220 |

Reflective types

Glass fiber optics

Glass fiber optics for Series 18, 30

Through beam types

Series 18
20-turn pot.

Series 18
Side mounted pot.
Teach-in

Series 30
Fast version

Series 30
Extended Sb

| Fiber diameter 2 x 1 mm ² | | Part number | Sb = actual range [mm] |
|---|---|---|--------------------------|
| Sheath material: PVC ø 2,5 mm (FSE ...) | Sheath material: brass chromium plated ø 4 mm (FSF ...) | | |
| | | FSE 050A2002 FSF 050A2004 (length 50 cm) | 90 270 200 450 |
| | * can not be bent | FSE 100A2002 FSF 100A2004 (length 100 cm) | 90 250 190 500 |
| | | FSE 050A2001 FSF 050A2005 (length 50 cm) | 90 270 200 450 |
| | * can not be bent | FSE 100A2001 FSF 100A2005 (length 100 cm) | 90 250 190 500 |
| | | FSE 050A1001 FSF 050A1005 (length 50 cm) | 90 270 200 450 |
| | * can not be bent | FSE 100A1001 FSF 100A1005 (length 100 cm) | 90 250 190 500 |
| | | FSE 050A4003 FSF 050A4003 (length 50 cm) | 90 270 200 450 |
| | | FSE 100A4003 FSF 100A4003 (length 100 cm) | 90 250 190 500 |
| Fiber diameter 2 x 2 mm ² | | Part number | Sb = actual range [mm] |
| Sheath material: PUR ø 4,5 mm (FSE ...) | Sheath material: brass chromium plated ø 5 mm (FSF ...) | | |
| | | FSE 050A2006 FSF 050A2002 (length 50 cm) | 180 450 380 450 |
| | | FSE 100A2006 FSF 100A2002 (length 100 cm) | 170 500 370 860 |
| | | FSE 050A1006 FSF 050A1002 (length 50 cm) | 180 450 380 450 |
| | | FSE 100A1006 FSF 100A1002 (length 100 cm) | 170 500 370 860 |
| | | FSE 050A4006 FSF 050A4002 (length 50 cm) | 180 450 380 450 |
| | | FSE 100A4006 FSF 100A4002 (length 100 cm) | 170 500 370 860 |

Through beam types

Glass fiber optics

Glass fiber optics for Series 18, 30

Through beam types

Series 18
20-turn pot.

Series 18
Side mounted pot.
Teach-in

Series 30
Fast version

Series 30
Extended Sb

| Fiber diameter 2 x 4 mm ² | | Part number | Sb = actual range [mm] |
|---------------------------------------|---|---|---------------------------|
| Sheath material: PVC ø 4 mm (FSE ...) | Sheath material: brass chromium plated ø 5 mm (FSF ...) | | |
| | | FSE 050A2003 FSF 050A2001 (length 50 cm) | 310 500 500 500 |
| | | FSE 100A2003 FSF 100A2001 (length 100 cm) | 300 800 600 1400 |
| | | FSE 050A1003 FSF 050A1001 (length 50 cm) | 310 500 500 500 |
| | | FSE 100A1003 FSF 100A1001 (length 100 cm) | 300 800 600 1400 |
| | | FSE 050A4004 FSF 050A4004 (length 50 cm) | 310 500 500 500 |
| | | FSE 100A4004 FSF 100A4004 (length 100 cm) | 300 800 600 1400 |

Arrays (for Series 18 only)

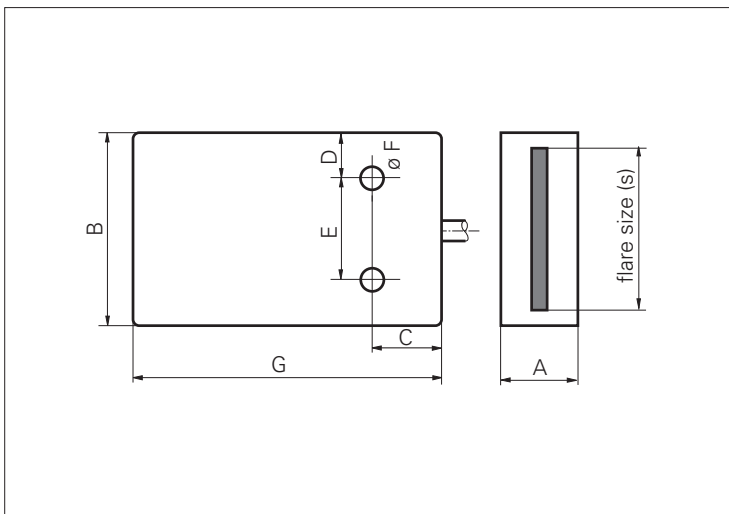

| Part number | Sb = actual range [mm] |
|---|------------------------|
| FSF 050A3020 FSE 050A3020 (length 50 cm) | 310 500 |
| FSF 100A3020 FSE 100A3020 (length 100 cm) | 310 800 |
| FSF 050A3021 FSF 050A3022 (length 50 cm) | 350 500 |
| FSF 100A3021 FSF 100A3022 (length 100 cm) | 350 900 |

| flare size s | dimensions mm | | | | | | | part number |
|----------------------------------|------------------|----|----|-----|----|-----|----|-------------------------------|
| | A | B | C | D | E | F | G | |
| 8 mm | 10 | 10 | - | - | - | - | 25 | FSF 050A3020 FSF 100A3020 |
| 8 mm | 10 | 10 | - | - | - | - | 25 | FSE 050A3020 FSE 100A3020 |
| 20 mm | 10 | 25 | 9 | 6.5 | 12 | 3,2 | 40 | FSF 050A3021 FSF 100A3021 |
| 35 mm | 12 | 40 | 12 | 7.5 | 25 | 4,2 | 50 | FSF 050A3022 FSF 100A3022 |
| metal sheath (FSF...) | | | | | | | | length 50 cm length 100 cm |
| plastic sheath (FSE...) (PUR) | | | | | | | | length 50 cm length 100 cm |

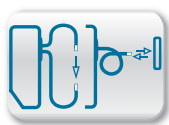

S_b = 1200 mm
Tw = 240 mm

- sensitivity adjustable via potentiometer
- fast version available
- rugged metal housing

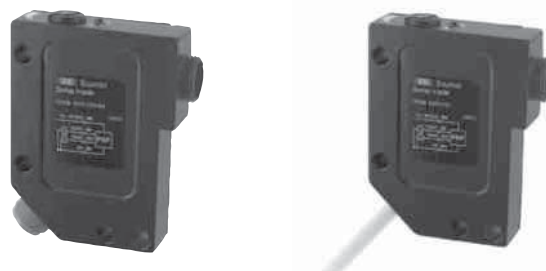

general data

| | |
|-------------------------------------|------------------------|
| actual range S _b | 1200 mm |
| sensing distance Tw | 240 mm |
| light source | pulsed infrared diode |
| light indicator | LED yellow |
| alignment / soiled lens indicator | LED, flashing |
| adjustment | potentiometer, 20 turn |
| wave length | 880 nm |
| suppression of reciprocal influence | yes |

electrical data

| | |
|--------------------------------------|----------------------|
| voltage supply range +V _s | 10 ... 30 VDC |
| voltage drop V _d | < 1,8 VDC |
| output function | light / dark operate |
| output current | < 200 mA |
| short circuit protection | yes |
| reverse polarity protection | yes |

mechanical data

| | |
|------------------|-------------------|
| width / diameter | 15 mm |
| height / length | 60 mm |
| depth | 45 mm |
| type | rectangular |
| housing material | die-cast aluminum |

ambient conditions

| | |
|-----------------------|----------------|
| operating temperature | -25 ... +65 °C |
| protection class | IP 65 |

connectors

| | | |
|--------------|-------|--------------|
| ESG 34AH0200 | 4 pin | 2 m straight |
| ESW 33AH0200 | 4 pin | 2 m angular |

additional cable connectors and field wireable connectors, see accessories

accessories

| | |
|--------------------------------------|----------|
| mounting bracket | 10103415 |
| for details, see accessories section | |

dimension drawings

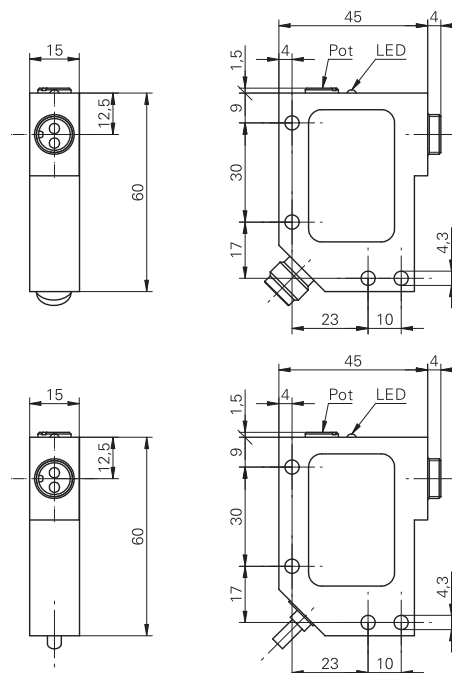

connection diagrams



FVDM 15 Sb = 1200 mm, Tw = 240 mm

Glass fiber optic sensors

| order reference | response time / release time | current consumption max. (no load) | current consumption typ. | output circuit | connection types |
|------------------|------------------------------|------------------------------------|--------------------------|----------------|---------------------|
| FVDM 15N5103 | < 1 ms | 46 mA | 30 mA | NPN | cable 4 pin, 2 m |
| FVDM 15N5103/S14 | < 1 ms | 46 mA | 30 mA | NPN | connector M12 4 pin |
| FVDM 15P5103 | < 1 ms | 46 mA | 30 mA | PNP | cable 4 pin, 2 m |
| FVDM 15P5103/S14 | < 1 ms | 46 mA | 30 mA | PNP | connector M12 4 pin |
| FVDM 15P5130 | < 0,1 ms | 60 mA | 50 mA | PNP | cable 4 pin, 2 m |
| FVDM 15P5130/S14 | < 0,1 ms | 60 mA | 50 mA | PNP | connector M12 4 pin |

Glass fiber optics for Series 15

Reflective types

| Fiber diameter 2 x 0,5 mm ² | | Part number | TW = sensing distance [mm] |
|--|--|--|----------------------------|
| Sheath material: PVC ø 2,5 mm (FUE ...) | Sheath material: brass chromium plated ø 4 mm (FUF ...) | | |
| | | FUE 025B2004 FUF 025B2004 (length 25 cm) | 25 |
| | * can not be bent | FUE 050B2004 FUF 050B2004 (length 50 cm) | 25 |
| | | FUE 025B2003 FUF 025B2003 (length 25 cm) | 25 |
| | * can not be bent | FUE 050B2003 FUF 050B2003 (length 50 cm) | 25 |
| | | FUE 025B1003 FUF 025B1003 (length 25 cm) | 25 |
| | * can not be bent | FUE 050B1003 FUF 050B1003 (length 50 cm) | 25 |
| | | FUE 025B4003 FUF 025B4006 (length 25 cm) | 25 |
| | | FUE 050B4003 FUF 050B4006 (length 50 cm) | 25 |
| Fiber diameter 2 x 1 mm ² | | Part number | TW = sensing distance [mm] |
| Sheath material: PUR ø 4,5 mm (FUE ...) | Sheath material: brass chromium plated ø 5 mm (FUF ...) | | |
| | | FUE 025B2002 FUF 025B2005 (length 25 cm) | 60 |
| | | FUE 050B2002 FUF 050B2005 (length 50 cm) | 60 |
| | | FUE 025B1002 FUF 025B1005 (length 25 cm) | 60 |
| | | FUE 050B1002 FUF 050B1005 (length 50 cm) | 60 |
| | | FUE 025B4005 FUF 025B4008 (length 25 cm) | 60 |
| | | FUE 050B4005 FUF 050B4008 (length 50 cm) | 60 |
| Fiber diameter 2 x 0,5 mm ² | | Part number | TW = sensing distance [mm] |
| Sheath material: Chrome-nickel-steel ø 2 mm FUH 010B2002 | Fiber diameter 2 x 1 mm ² Sheath material: Chrome-nickel-steel ø 3 mm FUH 010B2001 | | |
| | | FUH 010B2002 (length 10 cm) | 25 |
| | | FUH 010B2001 (length 10cm) | 60 |

Glass fiber optics for Series 15

Reflective types

Series 15

Reflective types

Glass fiber optics

| Fiber diameter 2 x 2 mm ² | | Part number | TW = sensing distance [mm] |
|---|---|--|----------------------------|
| Sheath material: PUR ø 4,5 mm (FUE ...) | Sheath material: brass chromium plated ø 5 mm (FUF ...) | | |
| | | FUE 025B2011 FUF 025B2011 (length 25 cm) | 110 |
| | | FUE 050B2011 FUF 050B2011 (length 50 cm) | 100 |
| | | FUE 025B1011 FUF 025B1011 (length 25 cm) | 110 |
| | | FUE 050B1011 FUF 050B1011 (length 50 cm) | 100 |
| | | FUE 025B4004 FUF 025B4002 (length 25 cm) | 110 |
| | | FUE 050B4004 FUF 050B4002 (length 50 cm) | 100 |
| Fiber diameter 2 x 3 mm ² | | Part number | TW = sensing distance [mm] |
| Sheath material: PUR ø 6 mm (FUE ...) | Sheath material: brass chromium plated ø 6 mm (FUF ...) | | |
| | | FUE 025B2008 FUF 025B2002 (length 25 cm) | 210 |
| | | FUE 050B2008 FUF 050B2002 (length 50 cm) | 200 |
| | | FUE 025B1008 FUF 025B1002 (length 25 cm) | 210 |
| | | FUE 050B1008 FUF 050B1002 (length 50 cm) | 200 |
| | | FUE 025B3001 FUF 025B3001 (length 25 cm) | 210 |
| | | FUE 050B3001 FUF 050B3001 (length 50 cm) | 200 |
| Fiber diameter 2 x 4 mm ² | | Part number | TW = sensing distance [mm] |
| Sheath material: PUR ø 6 mm (FUE ...) | Sheath material: brass chromium plated ø 6 mm (FUF ...) | | |
| | | FUE 025B2001 FUF 025B2001 (length 25 cm) | 240 |
| | | FUE 050B2001 FUF 050B2001 (length 50 cm) | 230 |
| | | FUE 025B1001 FUF 025B1001 (length 25 cm) | 240 |
| | | FUE 050B1001 FUF 050B1001 (length 50 cm) | 230 |

Glass fiber optics for Series 15

Through beam types

Series 15

| Fiber diameter 2 x 1 mm ² | | Part number | Sb = actual range [mm] |
|---|---|--|------------------------|
| Sheath material: PVC ø 2,5 mm (FSE ...) | Sheath material: brass chromium plated ø 4 mm (FSF ...) | | |
| | | FSE 025B2002 FSF 025B2002 (length 25 cm) | 140 |
| | | FSE 050B2002 FSF 050B2002 (length 50 cm) | 320 |
| | | FSE 025B2001 FSF 025B2005 (length 25 cm) | 140 |
| | | FSE 050B2001 FSF 050B2005 (length 50 cm) | 320 |
| | | FSE 025B1001 FSF 025B1005 (length 25 cm) | 140 |
| | | FSE 050B1001 FSF 050B1005 (length 50 cm) | 320 |
| | | FSE 025B4003 FSF 025B4003 (length 25 cm) | 140 |
| | | FSE 050B4003 FSF 050B4003 (length 50 cm) | 320 |
| Fiber diameter 2 x 2 mm ² | | Part number | Sb = actual range [mm] |
| Sheath material: PUR ø 4,5 mm (FSE ...) | Sheath material: brass chromium plated ø 5 mm (FSF ...) | | |
| | | FSE 025B2006 FSF 025B2006 (length 25 cm) | 160 |
| | | FSE 050B2006 FSF 050B2006 (length 50 cm) | 450 |
| | | FSE 025B1007 FSF 025B1007 (length 25 cm) | 160 |
| | | FSE 050B1007 FSF 050B1007 (length 50 cm) | 450 |
| | | FSE 025B4006 FSF 025B4002 (length 25 cm) | 160 |
| | | FSE 050B4006 FSF 050B4002 (length 50 cm) | 450 |

Through beam types

Glass fiber optics

Glass fiber optics for Series 15

Through beam types

Series 15

| Fiber diameter 2 x 4 mm ² | | Part number | Sb = actual range [mm] |
|---------------------------------------|---|--|------------------------|
| Sheath material: PVC ø 4 mm (FSE ...) | Sheath material: brass chromium plated ø 5 mm (FSF ...) | | |
| | | FSE 025B2003 FSF 025B2001 (length 25 cm) | 160 |
| | | FSE 050B2003 FSF 050B2001 (length 50 cm) | 500 |
| | | FSE 025B1003 FSF 025B1001 (length 25 cm) | 160 |
| | | FSE 050B1003 FSF 050B1001 (length 50 cm) | 500 |
| | | FSE 025B4004 FSF 025B4004 (length 25 cm) | 160 |
| | | FSE 050B4004 FSF 050B4004 (length 50 cm) | 500 |

Through beam types

Glass fiber optics

Vision sensors

Edge/Profile recognition



Vision sensors *VeriSens*
ParCon and *PosCon* line sensors
SCATEC copy counter / edge sensor

Page 352
Page 365
Page 378

Vision sensors *VeriSens*[®]

Applications



- Presence and completeness check



- Acquisition of part location and correct position



- Reading of numbers and characters



- Reading of barcodes and matrix codes

Integration – easy and flexible



- Each 5 freely definable digital inputs / outputs
- Encoder interface



- Siemens SIMATIC[®] S7 function modules
- Process interface



- Visualization of live images and fault images
- Backup & Restore function



- Ethernet interface for system integration
- Gateway and NAT support



Fields of application

- Quality control
- Food & beverage
- Assembly/Handling
- Packaging industry
- Electronics industry
- Pharmaceutical industry

The image-processing *VeriSens*[®] vision sensors provide extensive capabilities for a variety of inspection tasks in automation technology. LED lighting, precision optics, a CCD or CMOS camera, processing electronics, and interfaces are integrated in the industrial-grade and compact metal housing (IP 67).

The unified user interface allows intuitive configuration of the vision sensors, even for non-experts in image processing. Visualization or a quick job switching when changing products are also available via a web interface.



Vision sensor *VeriSens*® for checking and sorting of products

- Presence control and acquisition of correct position of labels and caps



VeriSens® ID Series Reading of text and 1D/2D codes

- Multi Reader for text and codes (incl. GS1)
- Reading of text without font training
- Several codes are read simultaneously



VeriSens® CS Series Checking and sorting of products



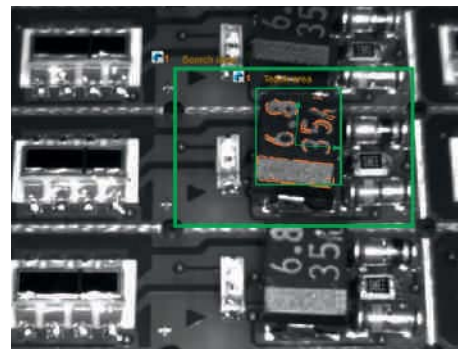

- Presence and completeness check
- Part recognition and part sorting
- Checking of part geometry



VeriSens® XF / XC Series Powerful for complex inspection tasks

- Largest set of *VeriSens*® functions
- Coordinate conversion for Pick & Place
- Result output via process interface



| product family | VS ID100M03 | VS ID110M03 | VS CS100M03 | VS XF100M03 |
|-----------------------|---|---|---|---|
| |  |  |  |  |
| | <i>VeriSens</i> ID-100 | <i>VeriSens</i> ID-110 | <i>VeriSens</i> CS-100 | <i>VeriSens</i> XF-100 |
| sensor | CMOS | CMOS | CMOS | CMOS |
| resolution (format) | 752 × 480 px (1/3") | 752 × 480 px (1/3") | 752 × 480 px (1/3") | 752 × 480 px (1/3") |
| lens (focal distance) | 10 / 16 mm | 10 mm | 10 / 16 mm | 10 / 16 mm |
| min. object distance | 50 / 70 mm | 50 mm | 50 / 70 mm | 50 / 70 mm |
| lighting LED white | ■ | ■ | ■ | ■ |
| lighting LED infrared | - | ■ | ■ | - |
| signal processing | processor Baumer FEX [®] 3.5 | processor Baumer FEX [®] 3.5 | processor Baumer FEX [®] 3.5 | processor Baumer FEX [®] 4.0 |
| communication | setup Ethernet (10 Base-T / 100 Base-TX) process interface TCP/IP RS 485 | setup Ethernet (10 Base-T / 100 Base-TX) process interface TCP/IP | setup Ethernet (10 Base-T / 100 Base-TX) | setup Ethernet (10 Base-T / 100 Base-TX) process interface TCP/IP |
| housing material | Aluminum and PMMA | Aluminum and PMMA | Aluminum and PMMA | Aluminum and PMMA |
| | | | | |
| page | 354 | 355 | 356 | 358 |

Overview

Vision sensors *VeriSens*[®]



| VS XF200M03 | VS XC100M | VS XC200M | | |
|---|---|---|--|--|
|  |  |  | | |
| <i>VeriSens</i> XF-200 | <i>VeriSens</i> XC-100 | <i>VeriSens</i> XC-200 | | |
| CMOS | CCD | CCD | | |
| 752 × 480 px (1/3") | 640 × 480 px (1/4") 1280 × 960 px (1/3") 1600 × 1200 px (1/1.8") | 640 × 480 px (1/4") 1280 × 960 px (1/3") 1600 × 1200 px (1/1.8") | | |
| 10 / 16 mm | none | none | | |
| 50 / 70 mm | depends on lens | depends on lens | | |
| ■ | - | - | | |
| ■ (10 mm) | - | - | | |
| processor FEX [®] 4.0 | processor FEX [®] 4.0 | processor Baumer FEX [®] 4.0 | | |
| setup Ethernet (10 Base-T / 100 Base-TX) process interface TCP/IP | setup Ethernet (10 Base-T / 100 Base-TX) process interface TCP/IP | setup Ethernet (10 Base-T / 100 Base-TX) process interface TCP/IP | | |
| Aluminum and PMMA | Aluminum and PMMA | Aluminum and PMMA | | |
| | | | | |
| 359 | 360 | 362 | | |



focal distance = 10 / 16 mm

- multi-code reader for 1D/2D codes (incl. GS1)
- reads and verifies codes simultaneously
- quality control of codes according to ISO/AIM

general data

| | |
|------------------------------|--|
| sensor | CMOS |
| resolution (format) | 752 × 480 px (1/3") |
| type | monochrome |
| illumination | white |
| speed | |
| High Resolution Mode: | max. 50 inspections/sec |
| High Speed Mode: | max. 100 inspections/sec |
| objectiv (focal distance) | 10 mm 16 mm |
| object distance min. | 50 mm 70 mm |
| inspection field min. | 26,4 × 16,9 mm 17,7 × 11,3 mm |
| number of jobs (products) | up to 255 |
| features per job | 32 |
| signal processing | processor Baumer FEX [®] 3.5 |
| inputs | 8 ... 30 VDC |
| outputs | PNP 100 mA |
| digital input | trigger, job selection, external teach-in, encoder (CH-A, CH-B) 500 kHz |
| digital output | Pass / Fail 1-3, Flash sync , Alarm, Camera Ready, Output Enable |
| communication | setup Ethernet (10 Base-T / 100 Base-TX) process interface TCP/IP RS 485 |

electrical data

| | |
|--------------------------|---|
| voltage supply range +Vs | 18 ... 30 VDC |
| power consumption max. | typ. 5 W (I _{max} = 1 A at 24 V) |

mechanical data

| | |
|------------------|-------------------|
| width / diameter | 53 mm |
| height / length | 99,5 mm |
| depth | 38 mm |
| type | rectangular |
| housing material | Aluminum and PMMA |
| weight | 250 g |

ambient conditions

| | |
|-----------------------------|-------------------------------|
| operating temperature | +5 ... +50 °C |
| humidity | 0 ... 90 % (non-condensing) |
| protection class | IP 67 |
| vibration load | IEC 60068-2-6, IEC 60068-2-64 |
| mechanical shock resistance | EN 60068-2-27 |

accessories

| | |
|--------------------------------------|----------------------|
| mounting bracket straight | 10159905 |
| mounting bracket angular | 10159906 |
| <i>VeriSens</i> Application Suite CD | included in delivery |
| for details, see accessories section | |

| order reference | lens | illumination |
|-------------------------|-------|--------------|
| VS ID100M03W10RP | 10 mm | white |
| VS ID100M03W16RP | 16 mm | white |



dimension drawing

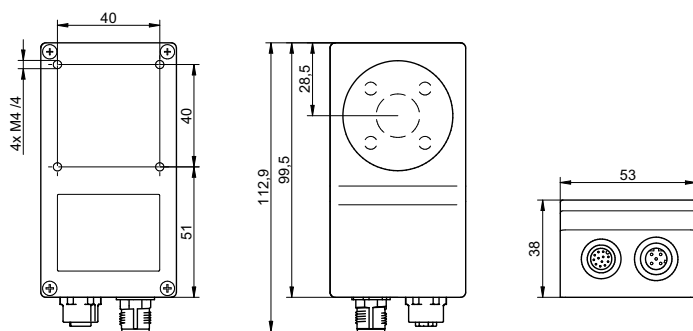

Electrical connection **Type M12 / 12-pin**

- 1: Power +18...30 VDC
- 2: Ground
- 3: IN1 (Trigger)
- 4: OUT1
- 5: IN2
- 6: OUT2
- 7: OUT3
- 8: IN3
- 9: RS 485+
- 10: IN4
- 11: IN5
- 12: RS 485-

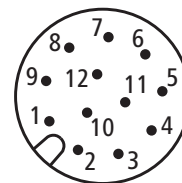

Ethernet interface **Type M12 / 4-pin**

- 1: TD+
- 2: RD+
- 3: TD-
- 4: RD-

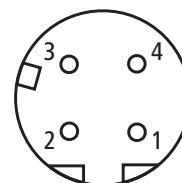

connectors

| | | |
|--|--------|-------------------------|
| ESG 34JP0200G | 12-pin | 2 m straight (shielded) |
| ESG 34JP0500G | 12-pin | 5 m straight (shielded) |
| KSG 34A/ KSG45AP0200G/E | 4-pin | 2 m straight (shielded) |
| KSG 34A/ KSG45AP0500G/E | 4-pin | 5 m straight (shielded) |
| additional cable connectors and field wireable connectors, see accessories | | |

functions

Barcode, Matrix code



focal distance = 10 mm

- multi reader for text and 1D/2D codes (incl. GS1)
- reads different fonts without font training
- verifies text (OCR/OCV), Quality control of codes



general data

| | |
|------------------------------|---|
| sensor | CMOS |
| resolution (format) | 752 × 480 px (1/3") |
| type | monochrome |
| illumination | white, infrared |
| speed | |
| High Resolution Mode: | max. 50 inspections/sec |
| High Speed Mode: | max. 100 inspections/sec |
| objectiv (focal distance) | 10 mm |
| object distance min. | 50 mm |
| inspection field min. | 26,4 × 16,9 mm |
| number of jobs (products) | up to 255 |
| features per job | 32 |
| signal processing | processor Baumer FEX [®] 3.5 |
| inputs | 8 ... 30 VDC |
| outputs | PNP 100 mA |
| digital input | trigger, job selection, external teach-in, encoder (CH-A, CH-B) 500 kHz |
| digital output | Pass / Fail 1-5, Flash sync , Alarm, Camera Ready, Output Enable |
| communication | setup Ethernet (10 Base-T / 100 Base-TX) process interface TCP/IP |

electrical data

| | |
|--------------------------|---|
| voltage supply range +Vs | 18 ... 30 VDC |
| power consumption max. | typ. 5 W (I _{max} = 1 A at 24 V) |

mechanical data

| | |
|------------------|-------------------|
| width / diameter | 53 mm |
| height / length | 99,5 mm |
| depth | 38 mm |
| type | rectangular |
| housing material | Aluminum and PMMA |
| weight | 250 g |

ambient conditions

| | |
|-----------------------------|-------------------------------|
| operating temperature | +5 ... +50 °C |
| humidity | 0 ... 90 % (non-condensing) |
| protection class | IP 67 |
| vibration load | IEC 60068-2-6, IEC 60068-2-64 |
| mechanical shock resistance | EN 60068-2-27 |

accessories

| | |
|--------------------------------------|----------------------|
| mounting bracket straight | 10159905 |
| mounting bracket angular | 10159906 |
| <i>VeriSens</i> Application Suite CD | included in delivery |

for details, see accessories section

dimension drawing

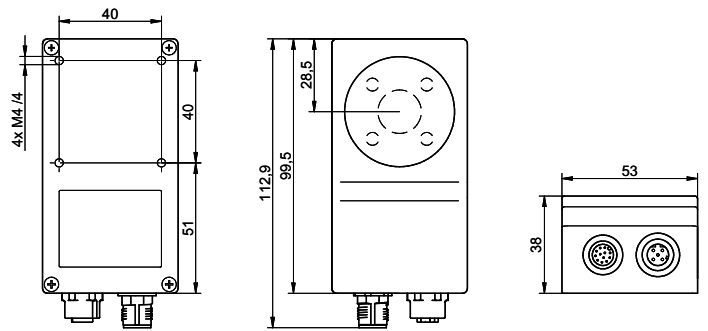

Electrical connection Type M12 / 12-pin

- 1: Power +18...30 VDC
- 2: Ground
- 3: IN1 (Trigger)
- 4: OUT1
- 5: IN2
- 6: OUT2
- 7: OUT3
- 8: IN3
- 9: OUT4
- 10: IN4
- 11: IN5
- 12: OUT5

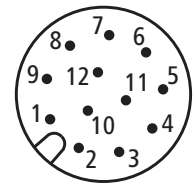

Ethernet interface Type M12 / 4-pin

- 1: TD+
- 2: RD+
- 3: TD-
- 4: RD-

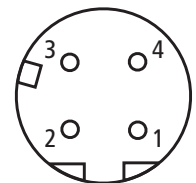

connectors

| | | |
|----------------------------|--------|-------------------------|
| ESG 34JP0200G | 12-pin | 2 m straight (shielded) |
| ESG 34JP0500G | 12-pin | 5 m straight (shielded) |
| KSG 34A/ KSG45AP0200G/E | 4-pin | 2 m straight (shielded) |
| KSG 34A/ KSG45AP0500G/E | 4-pin | 5 m straight (shielded) |

additional cable connectors and field wireable connectors, see accessories

order reference lens illumination

| | | |
|-------------------------|-------|----------|
| VS ID110M03W10EP | 10 mm | white |
| VS ID110M03I10EP | 10 mm | infrared |

functions

Barcode, Matrix code, Text



focal distance = 10 / 16 mm

- presence and completeness check
- 360° part recognition, part sorting
- checks geometry of parts

general data

| | | |
|------------------------------|---|----------------|
| sensor | CMOS | |
| resolution (format) | 752 × 480 px (1/3") | |
| type | monochrome | |
| illumination | white, infrared | |
| speed | | |
| High Resolution Mode: | max. 50 inspections/sec | |
| High Speed Mode: | max. 100 inspections/sec | |
| objectiv (focal distance) | 10 mm | 16 mm |
| object distance min. | 50 mm | 70 mm |
| inspection field min. | 26,4 × 16,9 mm | 17,7 × 11,3 mm |
| number of jobs (products) | up to 255 | |
| features per job | 32 | |
| signal processing | processor Baumer FEX [®] 3.5 | |
| inputs | 8 ... 30 VDC | |
| outputs | PNP 100 mA | |
| digital input | trigger, job selection, external teach-in, encoder (CH-A, CH-B) 500 kHz | |
| digital output | Pass / Fail 1-5, Flash sync , Alarm, Camera Ready, Output Enable | |
| communication | setup Ethernet (10 Base-T / 100 Base-TX) process interface: none | |

electrical data

| | |
|--------------------------|---|
| voltage supply range +Vs | 18 ... 30 VDC |
| power consumption max. | typ. 5 W (I _{max} = 1 A at 24 V) |

mechanical data

| | |
|------------------|-------------------|
| width / diameter | 53 mm |
| height / length | 99,5 mm |
| depth | 38 mm |
| type | rectangular |
| housing material | Aluminum and PMMA |
| weight | 250 g |

ambient conditions

| | |
|-----------------------------|-------------------------------|
| operating temperature | +5 ... +50 °C |
| humidity | 0 ... 90 % (non-condensing) |
| protection class | IP 67 |
| vibration load | IEC 60068-2-6, IEC 60068-2-64 |
| mechanical shock resistance | EN 60068-2-27 |

accessories

| | |
|--------------------------------------|----------------------|
| mounting bracket straight | 10159905 |
| mounting bracket angular | 10159906 |
| <i>VeriSens</i> Application Suite CD | included in delivery |
| for details, see accessories section | |

order reference

| order reference | lens | illumination |
|-------------------------|-------|--------------|
| VS CS100M03W10EP | 10 mm | white |
| VS CS100M03W16EP | 16 mm | white |
| VS CS100M03I10EP | 10 mm | infrared |
| VS CS100M03I16EP | 16 mm | infrared |



dimension drawing

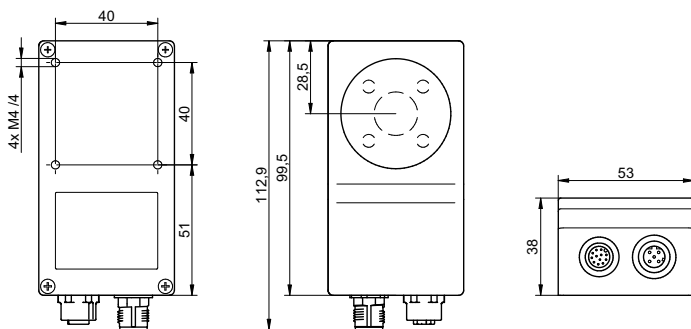

Electrical connection Type M12 / 12-pin

- 1: Power +18...30 VDC
- 2: Ground
- 3: IN1 (Trigger)
- 4: OUT1
- 5: IN2
- 6: OUT2
- 7: OUT3
- 8: IN3
- 9: OUT4
- 10: IN4
- 11: IN5
- 12: OUT5

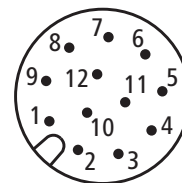

Ethernet interface Type M12 / 4-pin

- 1: TD+
- 2: RD+
- 3: TD-
- 4: RD-

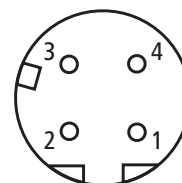

connectors

| | | |
|----------------------------|--------|-------------------------|
| ESG 34JP0200G | 12-pin | 2 m straight (shielded) |
| ESG 34JP0500G | 12-pin | 5 m straight (shielded) |
| KSG 34A/ KSG45AP0200G/E | 4-pin | 2 m straight (shielded) |
| KSG 34A/ KSG45AP0500G/E | 4-pin | 5 m straight (shielded) |

additional cable connectors and field wireable connectors, see accessories

functions

Part location on contours,
 Distance, Circle,
 Count contour points, Contour comparison, Brightness

VS CS100M03

Vision sensors *VeriSens*[®] ID-100



focal distance = 10 / 16 mm

- presence and completeness check
- acquisition of part location and correct position
- coordinate conversion

general data

| | |
|------------------------------|---|
| sensor | CMOS |
| resolution (format) | 752 × 480 px (1/3") |
| type | monochrome |
| illumination | white |
| speed | |
| High Resolution Mode: | max. 50 inspections/sec |
| High Speed Mode: | max. 100 inspections/sec |
| objectiv (focal distance) | 10 mm 16 mm |
| object distance min. | 50 mm 70 mm |
| inspection field min. | 26,4 × 16,9 mm 17,7 × 11,3 mm |
| number of jobs (products) | up to 255 |
| features per job | 32 |
| signal processing | processor Baumer FEX [®] 3.5 |
| inputs | 8 ... 30 VDC |
| outputs | PNP 100 mA |
| digital input | trigger, job selection, external teach-in, encoder (CH-A, CH-B) 500 kHz |
| digital output | Pass / Fail 1-5, Flash sync , Alarm, Camera Ready, Output Enable |
| communication | setup Ethernet (10 Base-T / 100 Base-TX) process interface TCP/IP |

electrical data

| | |
|--------------------------|---|
| voltage supply range +Vs | 18 ... 30 VDC |
| power consumption max. | typ. 5 W (I _{max} = 1 A at 24 V) |

mechanical data

| | |
|------------------|-------------------|
| width / diameter | 53 mm |
| height / length | 99,5 mm |
| depth | 38 mm |
| type | rectangular |
| housing material | Aluminum and PMMA |
| weight | 250 g |

ambient conditions

| | |
|-----------------------------|-------------------------------|
| operating temperature | +5 ... +50 °C |
| humidity | 0 ... 90 % (non-condensing) |
| protection class | IP 67 |
| vibration load | IEC 60068-2-6, IEC 60068-2-64 |
| mechanical shock resistance | EN 60068-2-27 |

accessories

| | |
|--------------------------------------|----------------------|
| mounting bracket straight | 10159905 |
| mounting bracket angular | 10159906 |
| <i>VeriSens</i> Application Suite CD | included in delivery |
| for details, see accessories section | |

order reference

| order reference | lens | illumination |
|-------------------------|-------|--------------|
| VS XF100M03W10EP | 10 mm | white |
| VS XF100M03W16EP | 16 mm | white |



dimension drawing

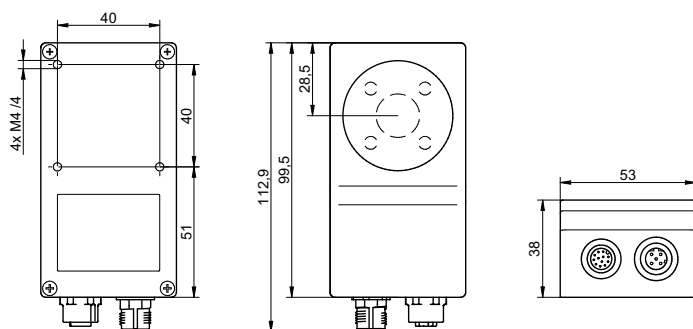

Electrical connection **Type M12 / 12-pin**

- 1: Power +18...30 VDC
- 2: Ground
- 3: IN1 (Trigger)
- 4: OUT1
- 5: IN2
- 6: OUT2
- 7: OUT3
- 8: IN3
- 9: OUT4
- 10: IN4
- 11: IN5
- 12: OUT5

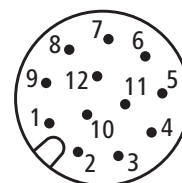

Ethernet interface **Type M12 / 4-pin**

- 1: TD+
- 2: RD+
- 3: TD-
- 4: RD-

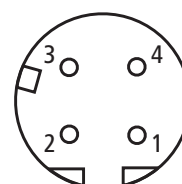

connectors

| | | |
|----------------------------|--------|-------------------------|
| ESG 34JP0200G | 12-pin | 2 m straight (shielded) |
| ESG 34JP0500G | 12-pin | 5 m straight (shielded) |
| KSG 34A/ KSG45AP0200G/E | 4-pin | 2 m straight (shielded) |
| KSG 34A/ KSG45AP0500G/E | 4-pin | 5 m straight (shielded) |

additional cable connectors and field wireable connectors, see accessories

functions

Part location on contours, Part location on edges, Part location on circle, Part location on text line, Distance, Circle, Angle, Count edges, Point position, Count contour points, Contour comparison, Brightness, Contrast, Area size, Count areas, Pattern comparison



focal distance = 10 / 16 mm

- presence and completeness check
- acquisition of part location and correct position
- identification of text and 1D/2D codes



general data

| | |
|------------------------------|---|
| sensor | CMOS |
| resolution (format) | 752 × 480 px (1/3") |
| type | monochrome |
| illumination | white, infrared |
| speed | |
| High Resolution Mode: | max. 50 inspections/sec |
| High Speed Mode: | max. 100 inspections/sec |
| objectiv (focal distance) | 10 mm 16 mm |
| object distance min. | 50 mm 70 mm |
| inspection field min. | 26,4 × 16,9 mm 17,7 × 11,3 mm |
| number of jobs (products) | up to 255 |
| features per job | 32 |
| signal processing | processor Baumer FEX [®] 3.5 |
| inputs | 8 ... 30 VDC |
| outputs | PNP 100 mA |
| digital input | trigger, job selection, external teach-in, encoder (CH-A, CH-B) 500 kHz |
| digital output | Pass / Fail 1-5, Flash sync , Alarm, Camera Ready, Output Enable |
| communication | setup Ethernet (10 Base-T / 100 Base-TX) process interface TCP/IP |

electrical data

| | |
|--------------------------|---|
| voltage supply range +Vs | 18 ... 30 VDC |
| power consumption max. | typ. 5 W (I _{max} = 1 A at 24 V) |

mechanical data

| | |
|------------------|-------------------|
| width / diameter | 53 mm |
| height / length | 99,5 mm |
| depth | 38 mm |
| type | rectangular |
| housing material | Aluminum and PMMA |
| weight | 250 g |

ambient conditions

| | |
|-----------------------------|-------------------------------|
| operating temperature | +5 ... +50 °C |
| humidity | 0 ... 90 % (non-condensing) |
| protection class | IP 67 |
| vibration load | IEC 60068-2-6, IEC 60068-2-64 |
| mechanical shock resistance | EN 60068-2-27 |

accessories

| | |
|--------------------------------------|----------------------|
| mounting bracket straight | 10159905 |
| mounting bracket angular | 10159906 |
| <i>VeriSens</i> Application Suite CD | included in delivery |
| for details, see accessories section | |

| order reference | lens | illumination |
|-------------------------|-------|--------------|
| VS XF200M03W10EP | 10 mm | white |
| VS XF200M03W16EP | 16 mm | white |
| VS XF200M03I10EP | 10 mm | infrared |

dimension drawing

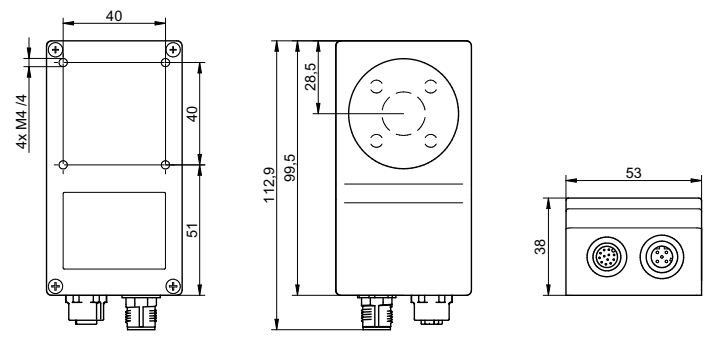

Electrical connection Type M12 / 12-pin

- 1: Power +18...30 VDC
- 2: Ground
- 3: IN1 (Trigger)
- 4: OUT1
- 5: IN2
- 6: OUT2
- 7: OUT3
- 8: IN3
- 9: OUT4
- 10: IN4
- 11: IN5
- 12: OUT5

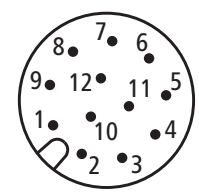

Ethernet interface Type M12 / 4-pin

- 1: TD+
- 2: RD+
- 3: TD-
- 4: RD-

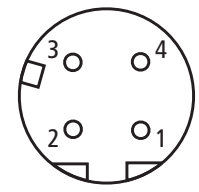

connectors

| | | |
|-------------------------|--------|-------------------------|
| ESG 34JP0200G | 12-pin | 2 m straight (shielded) |
| ESG 34JP0500G | 12-pin | 5 m straight (shielded) |
| KSG 34A/ KSG45AP0200G/E | 4-pin | 2 m straight (shielded) |
| KSG 34A/ KSG45AP0500G/E | 4-pin | 5 m straight (shielded) |

additional cable connectors and field wireable connectors, see accessories

functions

Part location on contours, Part location on edges, Part location on circle, Part location on text line, Distance, Circle, Angle, Count edges, Point position, Count contour points, Contour comparison, Brightness, Contrast, Area size, Count areas, Pattern comparison, Barcode, Matrix code, Text



- presence and completeness check
- acquisition of part location and correct position
- coordinate conversion



general data

| | |
|---------------------------|--|
| sensor | CCD |
| resolution (format) | 640 × 480 px (1/4") ¹⁾ 1280 × 960 px (1/3") ²⁾ 1600 × 1200 px (1/1.8") ³⁾ |
| type | monochrome |
| speed | |
| High Resolution Mode: | max. 50 ¹⁾ / 12 ²⁾ / 7 ³⁾ inspect./sec |
| High Speed Mode: | max. 100 ¹⁾ / 25 ²⁾ / 15 ³⁾ inspect./sec |
| number of jobs (products) | up to 255 |
| features per job | 32 |
| signal processing | Processor Baumer FEX [®] 4.0 |
| inputs | 8 ... 30 VDC |
| outputs | PNP 100 mA |
| digital input | trigger, job selection, external teach-in, encoder (CH-A, CH-B) 500 kHz |
| digital output | Pass / Fail 1-5, Flash sync , Alarm, Camera Ready, Output Enable |
| communication | setup Ethernet (10 Base-T / 100 Base-TX) process interface TCP/IP |

electrical data

| | |
|--------------------------|---|
| voltage supply range +Vs | 18 ... 30 VDC |
| power consumption max. | typ. 5 W (I _{max} = 1,5 A at 24 V) |

mechanical data

| | |
|------------------|-------------------------------|
| width / diameter | 53 mm |
| height / length | 99,5 mm |
| depth | 49,8 mm (without lens / tube) |
| type | rectangular |
| housing material | Aluminum and PMMA |
| weight | 300 g (without lens / tube) |

ambient conditions

| | |
|-----------------------------|-------------------------------|
| operating temperature | +5 ... +50 °C |
| humidity | 0 ... 90 % (non-condensing) |
| protection class | IP 67 (with tube) |
| vibration load | IEC 60068-2-6, IEC 60068-2-64 |
| mechanical shock resistance | EN 60068-2-27 |

dimension drawing device

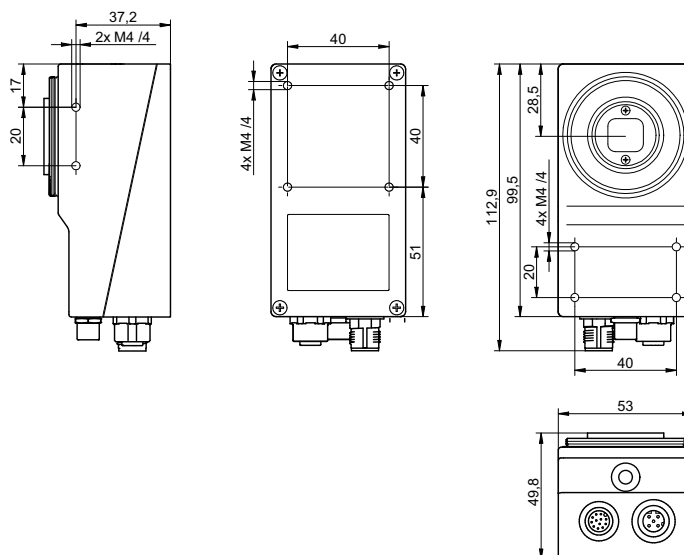

dimension drawing tube / tube module

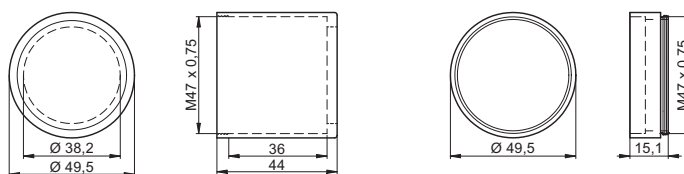

accessories

| | |
|--------------------------------------|----------------------|
| XC tube | 11088325 |
| XC tube module | 11089149 |
| mounting bracket straight | 10159905 |
| mounting bracket angular | 10159906 |
| <i>VeriSens</i> Application Suite CD | included in delivery |
| for details, see accessories section | |

order reference

| order reference | resolution |
|-------------------------|-------------------------|
| VS XC100M03X00EP | 640 × 480 px (1/4") |
| VS XC100M12X00EP | 1280 × 960 px (1/3") |
| VS XC100M20X00EP | 1600 × 1200 px (1/1.8") |

functions

Part location on contours, Part location on edges, Part location on circle, Part location on text line, Distance, Circle, Angle, Count edges, Point position, Count contour points, Contour comparison, Brightness, Contrast, Area size, Count areas, Pattern comparison



Electrical connection Type M12 / 12-pin

- 1: Power +18...30 VDC
- 2: Ground
- 3: IN1 (Trigger)
- 4: OUT1
- 5: IN2
- 6: OUT2
- 7: OUT3
- 8: IN3
- 9: OUT4
- 10: IN4
- 11: IN5
- 12: OUT5

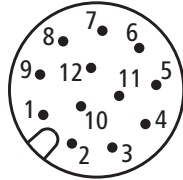

Ethernet interface Type M12 / 4-pin

- 1: TD+
- 2: RD+
- 3: TD-
- 4: RD-

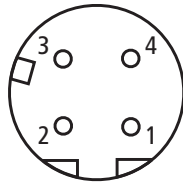

Electr. connection illumination* Type M8 / 4-pin

- 1: +24 V or +48 V Flash
- 2: +12 V or +24 V Flash
- 3: Ground
- 4: Flash Sync

* Voltage outputs configurable by software

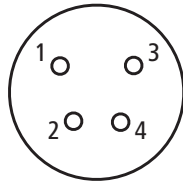

connectors

| | | |
|----------------------------|--------------|--|
| ESG 34JP0200G | M12 / 12-pin | 2 m straight (shielded) |
| ESG 34JP0500G | M12 / 12-pin | 5 m straight (shielded) |
| KSG 34A/ KSG45AP0200G/E | M12 / 4-pin | 2 m straight (shielded) |
| KSG 34A/ KSG45AP0500G/E | M12 / 4-pin | 5 m straight (shielded) |
| ESG32A/JSTBV0030 | M8 / 4-pin | 30 cm straight (shielded), to JST 3-pin |
| ESG32A/JSTSV0030 | M8 / 4-pin | 30 cm straight (shielded), to JST 2-pin |

additional cable connectors and field wireable connectors, see accessories



- presence and completeness check
- acquisition of part location and correct position
- identification of text and 1D/2D codes



general data

| | |
|---------------------------|--|
| sensor | CCD |
| resolution (format) | 640 × 480 px (1/4") ¹⁾ 1280 × 960 px (1/3") ²⁾ 1600 × 1200 px (1/1.8") ³⁾ |
| type | monochrome |
| speed | |
| High Resolution Mode: | max. 50 ¹⁾ / 12 ²⁾ / 7 ³⁾ inspect./sec |
| High Speed Mode: | max. 100 ¹⁾ / 25 ²⁾ / 15 ³⁾ inspect./sec |
| number of jobs (products) | up to 255 |
| features per job | 32 |
| signal processing | Processor Baumer FEX [®] 4.0 |
| inputs | 8 ... 30 VDC |
| outputs | PNP 100 mA |
| digital input | trigger, job selection, external teach-in, encoder (CH-A, CH-B) 500 kHz |
| digital output | Pass / Fail 1-5, Flash sync , Alarm, Camera Ready, Output Enable |
| communication | setup Ethernet (10 Base-T / 100 Base-TX) process interface TCP/IP |

electrical data

| | |
|--------------------------|---|
| voltage supply range +Vs | 18 ... 30 VDC |
| power consumption max. | typ. 5 W (I _{max} = 1,5 A at 24 V) |

mechanical data

| | |
|------------------|-------------------------------|
| width / diameter | 53 mm |
| height / length | 99,5 mm |
| depth | 49,8 mm (without lens / tube) |
| type | rectangular |
| housing material | Aluminum and PMMA |
| weight | 300 g (without lens / tube) |

ambient conditions

| | |
|-----------------------------|-------------------------------|
| operating temperature | +5 ... +50 °C |
| humidity | 0 ... 90 % (non-condensing) |
| protection class | IP 67 (with tube) |
| vibration load | IEC 60068-2-6, IEC 60068-2-64 |
| mechanical shock resistance | EN 60068-2-27 |

order reference

| order reference | resolution |
|------------------|-------------------------|
| VS XC200M03X00EP | 640 × 480 px (1/4") |
| VS XC200M12X00EP | 1280 × 960 px (1/3") |
| VS XC200M20X00EP | 1600 × 1200 px (1/1.8") |

dimension drawing device

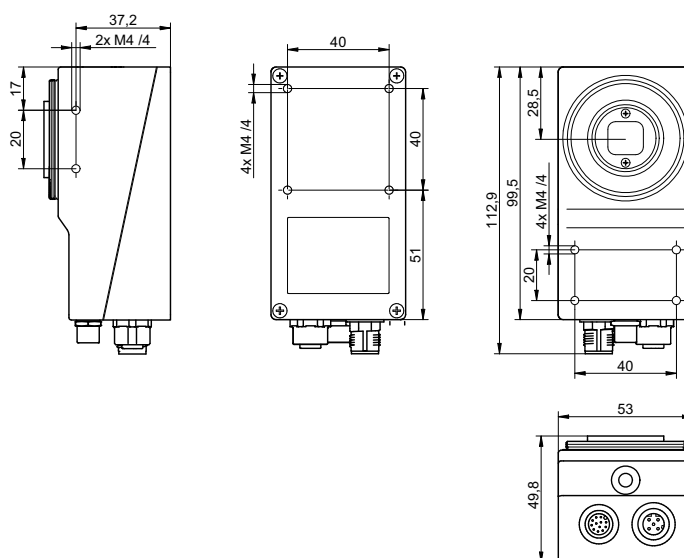

dimension drawing tube / tube module

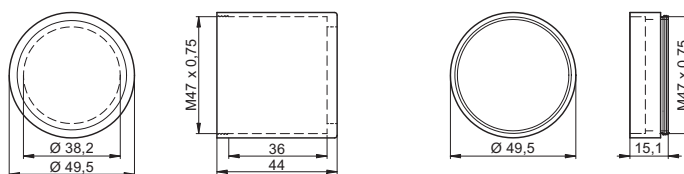

accessories

| | |
|--------------------------------------|----------------------|
| XC tube | 11088325 |
| XC tube module | 11089149 |
| mounting bracket straight | 10159905 |
| mounting bracket angular | 10159906 |
| <i>VeriSens</i> Application Suite CD | included in delivery |
| for details, see accessories section | |

functions

Part location on contours, Part location on edges, Part location on circle, Part location on text line, Distance, Circle, Angle, Count edges, Point position, Count contour points, Contour comparison, Brightness, Contrast, Area size, Count areas, Pattern comparison, Barcode, Matrix code, Text



Electrical connection Type M12 / 12-pin

- 1: Power +18...30 VDC
- 2: Ground
- 3: IN1 (Trigger)
- 4: OUT1
- 5: IN2
- 6: OUT2
- 7: OUT3
- 8: IN3
- 9: OUT4
- 10: IN4
- 11: IN5
- 12: OUT5

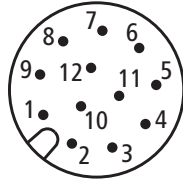

Ethernet interface Type M12 / 4-pin

- 1: TD+
- 2: RD+
- 3: TD-
- 4: RD-

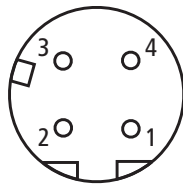

Electr. connection illumination* Type M8 / 4-pin

- 1: +24 V or +48 V Flash
- 2: +12 V or +24 V Flash
- 3: Ground
- 4: Flash Sync

* Voltage outputs configurable by software

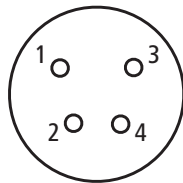





connectors

| | | |
|----------------------------|--------------|--|
| ESG 34JP0200G | M12 / 12-pin | 2 m straight (shielded) |
| ESG 34JP0500G | M12 / 12-pin | 5 m straight (shielded) |
| KSG 34A/ KSG45AP0200G/E | M12 / 4-pin | 2 m straight (shielded) |
| KSG 34A/ KSG45AP0500G/E | M12 / 4-pin | 5 m straight (shielded) |
| ESG32A/JSTBV0030 | M8 / 4-pin | 30 cm straight (shielded), to JST 3-pin |
| ESG32A/JSTSV0030 | M8 / 4-pin | 30 cm straight (shielded), to JST 2-pin |

additional cable connectors and field wireable connectors, see accessories



| product family | ZADM 034 | ZADM 034 | ZADM 034 |
|--------------------------------|---|---|---|
| |  |  |  |
| | <i>ParCon</i> | <i>ParCon</i> | <i>ParCon</i> |
| type | measuring mode: edges, width | measuring mode: edges, width measuring mode: sum of all dark areas, edges | switchable |
| measuring field size | 24 mm | 22 mm | 24 mm |
| measuring distance (to object) | 0 ... 40 mm | | 0 ... 40 mm |
| measuring range towards object | | 0 ... 200 mm | |
| measuring frequency | > 1800 Hz > 2000 Hz | > 1100 Hz | > 4000 Hz |
| output signal | 4 ... 20 mA | 4 ... 20 mA | |
| PNP | | | ■ |
| analog | ■ | ■ | |
| connector | ■ | ■ | ■ |
| | | | |
| page | 368 | 370 | 372 |

| product family | ZADM 023 | ZADM 023 |
|--|---|---|
| |  |  |
| | <i>PosCon</i> | <i>PosCon</i> |
| type | measuring mode: edges, center, width | measuring mode: edges, center, width |
| measuring field size | 30 mm 150 mm 350 mm | |
| measuring field size (dep. on measuring dist.) | | 400 ... 875 mm |
| measuring distance (to object) | 50 mm 200 mm 500 mm | 640 ... 1400 mm |
| measuring frequency | > 500 Hz | > 500 Hz |
| analog and RS 485 | ■ | ■ |
| output signal | 4 ... 20 mA | 4 ... 20 mA |
| connector | ■ | ■ |
| | | |
| page | 374 | 376 |



General information

Line sensors are used to detect object widths and object positions. The position / width is issued as an analog value with high accuracy proportional to the overall measuring area. Although smaller than a deck of playing cards, the sensors contain not only the complete signal conditioning, but also a long-life illumination unit.

The simple switching version of the *ParCon* also allows the detection of small objects within the measuring area.

Applications

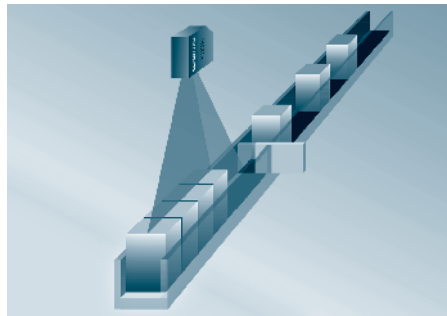

Edge detection (*PosCon*, *ParCon*)

- Control of textile, plastic or paper edges
- Positioning of objects by the edge
- Level measurement

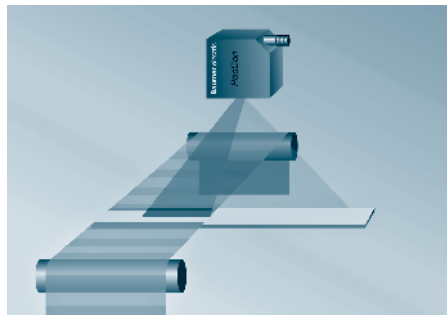

Width measurement (*PosCon*, *ParCon*)

- Width inspection during the production of fabric and rubber bands

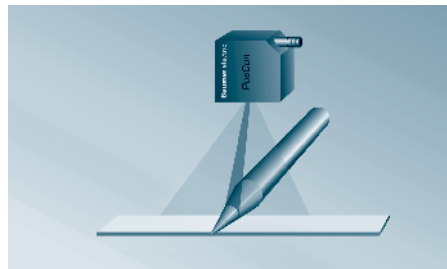

Center position (*PosCon*)

- Position measurement by the object center, by which bands or objects of different width can be aligned centrally to each other

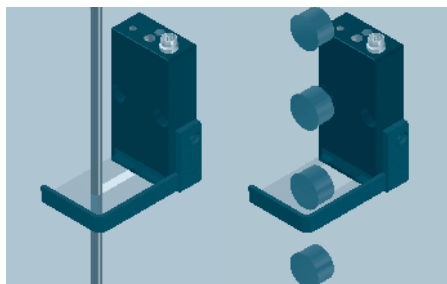

Counting and detecting objects (*ParCon*), switching output

- Detection and counting of small objects falling through the measurement area
- Wire and belt break monitoring



Characteristics and advantages

ParCon line sensor

- The two measuring modes (edge, width, center) can be set by a push of a button.
- Due to the parallel light beams, the vertical movement of fabric webs does not affect the measurement signal.
- The high measuring frequency of 1000 Hz in the analog sensor also allows rapid movements to be detected.
- Due to the high measuring frequency of 4 kHz, even small, rapidly moving parts are reliably detected.

PosCon line sensor

- The measuring area can be restricted by a simple Teach-in process to suppress interfering objects and areas.
- The three different measuring modes (width, edge, center) can be set simply by a push of a button.
- Two threshold values can be programmed with the Teach-in button and serve as tolerance limits for the switching output.
- All functions available with the buttons can also be operated via an RS 485 interface.
- The position and other information can be read via the interface.
- Measurement is possible on transparent objects and films.

Technology and operation

With the line sensors, the light of the integrated illumination is reflected by a reflective film (special film) installed opposite the sensor and is received by the diode line. The length of the diode line and the optics determine the measuring area. Due to the narrow diode line, the measuring area is also only a narrow band. If an object obstructs a part of the light, no light falls on the corresponding part of the diode line. The integrated microcontroller processes the shaded areas and the transitions from dark to light and calculates the corresponding analog value according to the measuring mode.

The optics of the *PosCon* and the *ParCon* are constructed differently. The *PosCon* has a diverging measuring field. This makes large measuring areas of up to 800 mm possible. The specified measuring area is achieved at the nominal distance. It becomes larger or smaller proportionally with the distance. This causes an object to appear larger or smaller according to the distance.

The *ParCon* has a parallel measuring field, making an object appear equal in size in the entire measuring area.

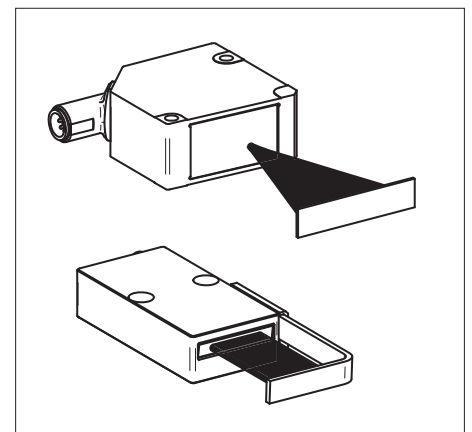

Mounting and adjustment

The reflective tape specified in the documentation must be used for the *PosCon* and *ParCon*.

If the reflective tape is protected against abrasion by a Plexiglas or glass sheet, this must be tilted 7° to the sensor to ensure that the direct reflection does not reflect to the receiver. The reflective tape for the *ParCon* is covered by a protective film. If highly reflective objects are measured, it is conceivable that a direct reflection will occur just as strong as the light from the reflective film. In this case, measuring errors can occur. This can be prevented by tilting the sensor away from the object.



measuring field size = 24 mm

- measuring of edge position and object width
- parallel, uniform light beam
- high measuring frequency

general data

| | |
|--------------------------------|---|
| type | measuring mode: edges, width |
| measuring field size | 24 mm |
| measuring distance (to object) | 0 ... 40 mm |
| resolution | < 0,05 mm |
| smallest object recognizable | 1 mm |
| linearity error | ± 0,4 mm (S = 0...40 mm) ± 0,2 mm (S = 20...40 mm) |
| repeat accuracy | < 0,05 mm |
| power on indication | LED green |
| output indicator | LED yellow |
| light source | pulsed infrared diode |
| wave length | 880 nm |

electrical data

| | |
|------------------------------------|----------------|
| response time | < 0,6 ms |
| voltage supply range +Vs | 12 ... 28 VDC |
| current consumption max. (no load) | 120 mA |
| output circuit | analog |
| output signal | 4 ... 20 mA |
| reverse polarity protection | yes, Vs to GND |
| short circuit protection | yes |

mechanical data

| | |
|------------------|--------------------|
| width / diameter | 34 mm |
| housing material | aluminum |
| front (optics) | glass |
| connection types | connector M8 4 pin |

ambient conditions

| | |
|-----------------------|--------------|
| operating temperature | 0 ... +55 °C |
| protection class | IP 67 |

remarks

reflector bracket can be replaced with a reflective tape.



connection diagram

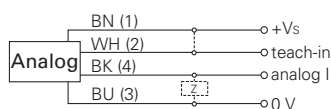

connectors

| | | |
|---------------|-------|-------------------------|
| ESG 32AP0200G | 4 pin | 2 m straight (shielded) |
| ESG 32AP0500G | 4 pin | 5 m straight (shielded) |
| ESW 31AP0500G | 4 pin | 5 m angular (shielded) |

additional cable connectors and field wireable connectors, see accessories

| order reference | type | measuring frequency |
|-------------------|-------------------------|---------------------|
| ZADM 034I240.0001 | rectangular, side view | > 1800 Hz |
| ZADM 034I240.0021 | rectangular, front view | > 2000 Hz |



reflectors

| | |
|-----------------|--|
| FTDF 012M050 | tape 12 x 50 mm (included) |
| FTDR 008M030/01 | bracket for ZADM 034x240.xx01 (included) |
| FTDR 008M030/21 | bracket for ZADM 034x240.xx21 (included) |

optional

| | |
|--------------|------------------|
| FTDF 050M234 | tape 50 x 234 mm |
|--------------|------------------|

dimension drawings

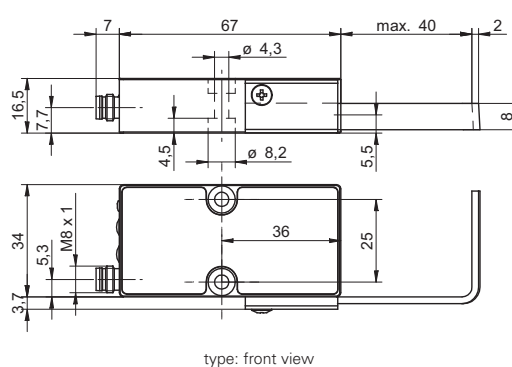
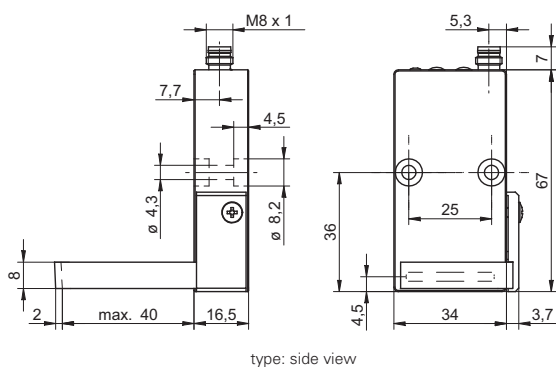



measuring field size = 22 mm

- measuring of edge position and object width
- parallel, uniform light beam
- high measuring frequency

general data

| | |
|--------------------------------|--|
| measuring field size | 22 mm |
| measuring range towards object | 0 ... 200 mm |
| measuring frequency | > 1100 Hz |
| resolution | < 0,1 mm (S = 0 ... 150 mm) < 0,2 mm (S = 150 ... 200 mm) |
| smallest object recognizable | 3 mm |
| linearity error | ± 1,75 mm (S = 0 ... 200 mm) ± 1 mm (S = 50 ... 150 mm) |
| repeat accuracy | < 0,1 mm (S = 0 ... 150 mm) < 0,2 mm (S = 150 ... 200 mm) |
| power on indication | LED green |
| output indicator | LED yellow |
| light source | pulsed infrared diode |
| wave length | 880 nm |

electrical data

| | |
|------------------------------------|----------------|
| response time | < 0,9 ms |
| voltage supply range +Vs | 12 ... 28 VDC |
| current consumption max. (no load) | 120 mA |
| output circuit | analog |
| output signal | 4 ... 20 mA |
| reverse polarity protection | yes, Vs to GND |
| short circuit protection | yes |

mechanical data

| | |
|------------------|-------------------------|
| width / diameter | 34 mm |
| type | rectangular, front view |
| housing material | aluminum |
| front (optics) | glass |
| connection types | connector M8 4 pin |

ambient conditions

| | |
|-----------------------|--------------|
| operating temperature | 0 ... +55 °C |
| protection class | IP 67 |

remarks

reflector bracket can be replaced with a reflective tape.

order reference**type**

| | |
|-------------------|--|
| ZADM 034I220.0021 | measuring mode: edges, width |
| ZADM 034I220.0022 | measuring mode: sum of all dark areas, edges |

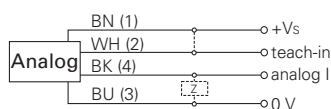
**connection diagram****connectors**

| | | |
|---------------|-------|-------------------------|
| ESG 32AP0200G | 4 pin | 2 m straight (shielded) |
| ESG 32AP0500G | 4 pin | 5 m straight (shielded) |
| ESW 31AP0500G | 4 pin | 5 m angular (shielded) |

additional cable connectors and field wireable connectors, see accessories

**reflectors**

FTDF 035M050 tape 12 x 50 mm (included)

optional

FTDF 050M234 tape 50 x 234 mm

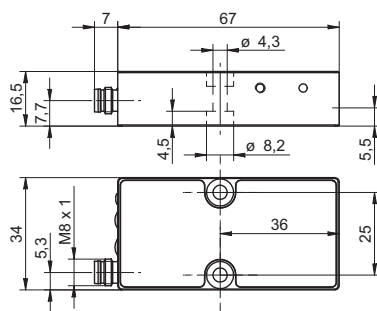
dimension drawing

type: front view



measuring field size = 24 mm

- detection of small objects
- measuring area 24 x 40 mm
- high measuring frequency

general data

| | |
|--------------------------------|-----------------------|
| type | switchable |
| measuring field size | 24 mm |
| measuring distance (to object) | 0 ... 40 mm |
| measuring frequency | > 4000 Hz |
| resolution | < 0,1 mm |
| smallest object recognizable | 0,5 mm |
| hysteresis | 0,4 mm |
| power on indication | LED green |
| light source | pulsed infrared diode |
| wave length | 880 nm |
| adjustment | Teach-in |

electrical data

| | |
|------------------------------------|----------------------|
| response time | < 0,25 ms |
| output pulse length | 10 ms |
| voltage supply range +Vs | 12 ... 28 VDC |
| current consumption max. (no load) | 120 mA |
| output circuit | PNP |
| output function | light / dark operate |
| output current | < 100 mA |
| voltage drop Vd | < 2,2 VDC |
| reverse polarity protection | yes, Vs to GND |
| short circuit protection | yes |

mechanical data

| | |
|------------------|--------------------|
| width / diameter | 34 mm |
| housing material | aluminum |
| front (optics) | glass |
| connection types | connector M8 4 pin |

ambient conditions

| | |
|-----------------------|--------------|
| operating temperature | 0 ... +55 °C |
| protection class | IP 67 |

remarks

reflector bracket can be replaced with a reflective tape.

order reference

| order reference | type |
|-------------------|-------------------------|
| ZADM 034P240.6901 | rectangular, side view |
| ZADM 034P240.6921 | rectangular, front view |

**connection diagram****connectors**

| | | |
|---------------|-------|-------------------------|
| ESG 32AP0200G | 4 pin | 2 m straight (shielded) |
| ESG 32AP0500G | 4 pin | 5 m straight (shielded) |
| ESW 31AP0500G | 4 pin | 5 m angular (shielded) |

additional cable connectors and field wireable connectors, see accessories



reflectors

| | |
|-----------------|--|
| FTDF 012M050 | tape 12 x 50 mm (included) |
| FTDR 008M030/01 | bracket for ZADM 034x240.xx01 (included) |
| FTDR 008M030/21 | bracket for ZADM 034x240.xx21 (included) |

optional

| | |
|--------------|------------------|
| FTDF 050M234 | tape 50 x 234 mm |
|--------------|------------------|

dimension drawings

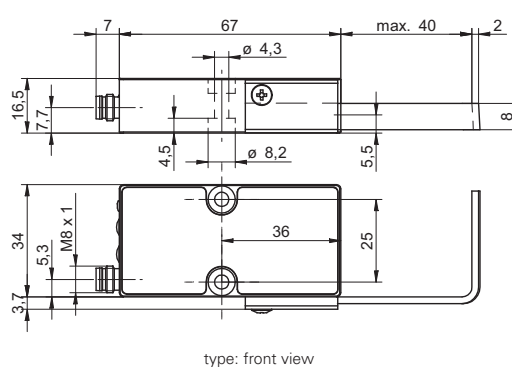
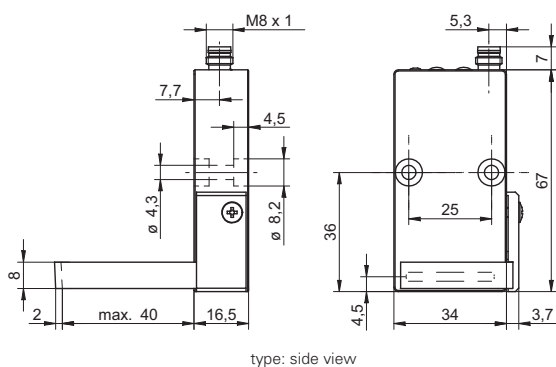



measuring field size = 350 mm



- Teach-in measuring range
- measuring mode: edges, center, width
- RS 485 interface

general data

| | |
|--------------------------|--------------------------------------|
| type | measuring mode: edges, center, width |
| measuring frequency | > 500 Hz |
| linearity error relative | < 0,3 % |
| light source | pulsed infrared diode |
| wave length | 880 nm |
| adjustment | Teach-in |

measuring field size = 30 mm

| | |
|--------------------------------|-----------|
| measuring distance (to object) | 50 mm |
| resolution | < 0,03 mm |
| smallest object recognizable | 0,3 mm |

measuring field size = 150 mm

| | |
|--------------------------------|-----------|
| measuring distance (to object) | 200 mm |
| resolution | < 0,15 mm |
| smallest object recognizable | 1,2 mm |

measuring field size = 350 mm

| | |
|--------------------------------|-----------|
| measuring distance (to object) | 500 mm |
| resolution | < 0,35 mm |
| smallest object recognizable | 4 mm |

electrical data

| | |
|------------------------------------|-------------------|
| response time | < 2 ms |
| voltage supply range +Vs | 15 ... 28 VDC |
| current consumption max. (no load) | 150 mA |
| output signal | 4 ... 20 mA |
| output current | < 100 mA |
| interface | analog and RS 485 |
| baud rate | 19200, adjustable |
| reverse polarity protection | yes, Vs to GND |

mechanical data

| | |
|------------------|--------------------------------|
| type | rectangular |
| housing material | die-cast zinc |
| front (optics) | glass |
| connection types | connector M12 8 pin, rotatable |

ambient conditions

| | |
|-----------------------|--------------|
| operating temperature | 0 ... +55 °C |
| protection class | IP 67 |

| order reference | measuring field size | output function | switching output |
|-------------------|----------------------|-----------------|------------------|
| ZADM 023H151.0001 | 150 mm | Out 1 / Alarm | PNP |
| ZADM 023H151.0002 | 150 mm | Out 1 / Alarm | NPN |
| ZADM 023H151.0011 | 150 mm | Out 1 / Out 2 | PNP |
| ZADM 023H151.0012 | 150 mm | Out 1 / Out 2 | NPN |
| ZADM 023H300.0001 | 30 mm | Out 1 / Alarm | PNP |
| ZADM 023H300.0002 | 30 mm | Out 1 / Alarm | NPN |
| ZADM 023H300.0011 | 30 mm | Out 1 / Out 2 | PNP |
| ZADM 023H300.0012 | 30 mm | Out 1 / Out 2 | NPN |
| ZADM 023H351.0001 | 350 mm | Out 1 / Alarm | PNP |
| ZADM 023H351.0002 | 350 mm | Out 1 / Alarm | NPN |
| ZADM 023H351.0011 | 350 mm | Out 1 / Out 2 | PNP |
| ZADM 023H351.0012 | 350 mm | Out 1 / Out 2 | NPN |

connection diagrams

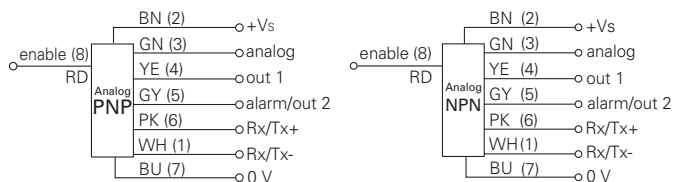

connectors

| | | |
|---------------|-------|-------------------------|
| ESG 34FP0200B | 8 pin | 2 m straight (shielded) |
| ESG 34FP0500B | 8 pin | 5 m straight (shielded) |

additional cable connectors and field wireable connectors, see accessories



reflectors

| | | reflector | reflector tape on reel | | reflective tape | |
|-----------------|--------|--------------|---------------------------|--------------|-----------------|-------------|
| measuring range | 30 mm | FTDR 005I040 | FTDL 005I000/... m | width 5 mm | FTDF 005I040 | 5 x 40 mm |
| measuring range | 150 mm | FTDR 020I175 | FTDL 020I000/... m | width 20 mm | FTDF 020I175 | 20 x 175 mm |
| measuring range | 350 mm | FTDR 035I395 | FTDL 035I000/... m | width 35 mm | FTDF 035I395 | 35 x 395 mm |
| | | | FTDL 610I000/... m | width 610 mm | | |

dimension drawing

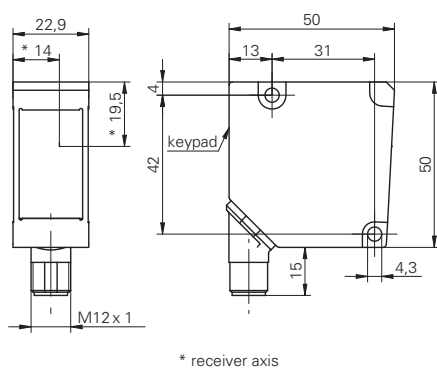

ZADM 023 measuring field size = 350 mm

Line sensors *PosCon*



measuring field size = 875 mm



- Teach-in measuring range
- measuring mode: edges, center, width
- RS 485 interface

general data

| | |
|--|--|
| type | measuring mode: edges, center, width |
| version | without filter for transparent objects |
| measuring field size (dep. on measuring dist.) | 400 ... 875 mm |
| measuring distance (to object) | 640 ... 1400 mm |
| measuring frequency | > 500 Hz |
| resolution | 0,5 ... 1 mm |
| smallest object recognizable | 8,5 ... 18 mm |
| linearity error relative | < 0,3 % |
| light source | pulsed infrared diode |
| wave length | 880 nm |
| adjustment | Teach-in |

electrical data

| | |
|------------------------------------|-------------------|
| response time | < 2 ms |
| voltage supply range +Vs | 15 ... 28 VDC |
| current consumption max. (no load) | 150 mA |
| output signal | 4 ... 20 mA |
| output current | < 100 mA |
| interface | analog and RS 485 |
| baud rate | 19200, adjustable |
| reverse polarity protection | yes, Vs to GND |
| short circuit protection | yes |

mechanical data

| | |
|------------------|--------------------------------|
| width / diameter | 23 mm |
| type | rectangular |
| housing material | die-cast zinc |
| front (optics) | glass |
| connection types | connector M12 8 pin, rotatable |

ambient conditions

| | |
|-----------------------|--------------|
| operating temperature | 0 ... +55 °C |
| protection class | IP 67 |

| order reference | output function | switching output |
|-------------------|-----------------|------------------|
| ZADM 023H871.0001 | Out 1 / Alarm | PNP |
| ZADM 023H871.0002 | Out 1 / Alarm | NPN |
| ZADM 023H871.0011 | Out 1 / Out 2 | PNP |
| ZADM 023H871.0012 | Out 1 / Out 2 | NPN |

connection diagrams

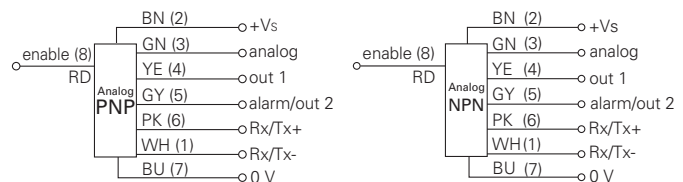

connectors

| | | |
|---------------|-------|-------------------------|
| ESG 34FP0200B | 8 pin | 2 m straight (shielded) |
| ESG 34FP0500B | 8 pin | 5 m straight (shielded) |

additional cable connectors and field wireable connectors, see accessories

ZADM 023 measuring field size = 875 mm

Line sensors PosCon



reflectors

FTDL 050I000/... m on reel, width 35 mm

FTDL 610I000/... m on reel, width 610 mm

conversion factors

| measuring distance (mm) | measuring field size (mm) |
|---|---------------------------|
| 640 | 400 |
| 1400 | 875 |
| meas. distance : meas. field size = 1,6 | |

| measuring distance (mm) | smallest object (mm) |
|---------------------------------------|----------------------|
| 640 | 8,5 |
| 1400 | 18 |
| meas. distance : smallest object = 75 | |

| measuring distance (mm) | resolution (mm) |
|------------------------------------|-----------------|
| 640 | 0,5 |
| 1400 | 1 |
| meas. distance : resolution = 1300 | |

| example | desired measuring field size | = 650 mm |
|-----------------|------------------------------|-----------|
| meas. distance | 650 mm x 1,6 | = 1040 mm |
| resolution | 1040 mm : 1300 | = 0,8 mm |
| smallest object | 1040 mm : 75 | = 13,9 mm |

dimension drawing

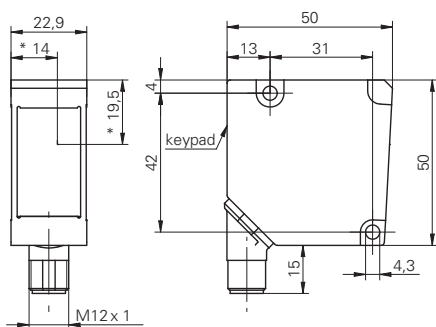

* receiver axis

| product family | FLDM 170 | FLDM 170 | FLDK 110 | FLDK 110 |
|----------------------------|---|---|---|---|
| |  |  |  |  |
| | <i>SCATEC-15</i> | <i>SCATEC-10</i> | <i>SCATEC-2</i> | <i>SCATEC-2 Gripper</i> |
| measuring distance Sd | 0 ... 120 mm | 0 ... 90 mm | 0 ... 60 mm 0 ... 120 mm | 0 ... 120 mm |
| optimum operating distance | 100 mm | 70 mm | 40 mm 100 mm | 70 mm |
| counting rate | < 3'000'000,00 copies/h | < 3'000'000,00 copies/h | < 600'000,00 copies/h | |
| output pulse length | 0,3 ... 500 ms selectable | 0,3 ... 500 ms selectable | 5 / 10 / 15 / 20 ms selectable | |
| sensitivity | single sheet/edge thickness 0,15 mm | single sheet/edge thickness 0,1 mm | single sheet/edge thickness 0,2 mm single sheet/edge thickness 0,25 mm | single sheet/edge thickness 0,25 mm |
| false pulse suppression | 4 program options | 4 program options | on/off switchable | |
| sensitivity adjustment | 4 preset levels or level set by customer | 4 preset levels or level set by customer | high/low switchable | |
| direct gap detection | yes | yes | | |
| interface | serial for ScaDiag software | serial for ScaDiag software | | |
| push-pull | ■ | ■ | ■ | ■ |
| opto isolated | ■ | ■ | ■ | |
| | | | | |
| page | 384 | 386 | 388 | 390 |

| | |
|----------|----------|
| FLDK 110 | FLDK 110 |
|----------|----------|



| | |
|--|---------------------------------------|
| SCATEC-2 Box | SCATEC-J |
| 0 ... 120 mm | 0 ... 55 mm |
| 100 mm | 40 mm |
| < 600'000,00 copies/h | < 280'000,00 copies/h |
| 5 / 10 ms selectable | 10 ms |
| single sheet/edge thickness 0,25 mm | single sheet/edge thickness 1,5 mm |
| on/off switchable | no |
| | |
| ■ | ■ |
| | |
| 392 | 394 |



General information

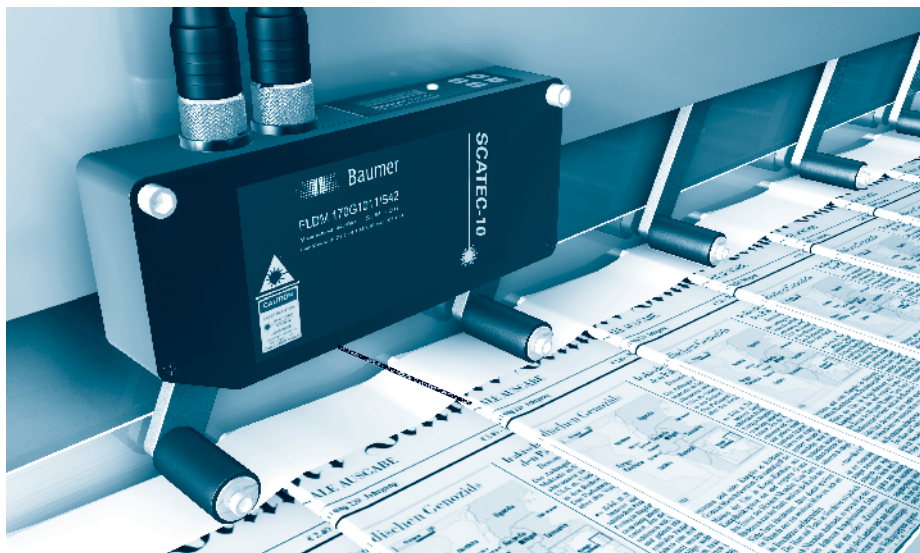

The sensors in the *SCATEC* range were developed specifically for non-contact counting of overlapped paper sheets and newspapers. Other flat objects conveyed in a lap stream or individually can also be counted. If such an object moves through the laser beam, the sensor replies with an electrical impulse with a fixed time period. The patented optical principle permits objects to be detected regardless of their color and surface; matte black objects are counted just as accurately as white glossy ones.

Characteristics and advantages

- **Counts regardless of the motion of product direction**
The copies are counted when an edge facing the laser beam moves through the beam, whether the direction of product motion is forwards or backwards.
- **Visible laser beam**
The red laser line is easily visible on the object and permits simple alignment.
- **Color insensitivity**
The integrated laser controller makes the SCATEC extremely insensitive to different surfaces of the object.
- **No blind region**
Large counted objects can even touch the sensor without causing counting errors.
- **Sensitivity adjustment**
Depending on the model, the sensitivity can be adjusted with a DIP switch, on the control panel or via the interface.
- **Edge indicator**
Yellow LED: light is on as long as an edge is in the laser beam.



Characteristics and advantages

Multiple pulse suppression

Particularly with thick copies (newspapers, folded cardboard boxes etc.) or with a small prefold, multiple pulses which can occur at the edge can be suppressed by this function. Error pulse suppression operates by preventing further pulses from being emitted when an output pulse is active or during an idle time. The following programs guarantee optimum adjustment to all counting problems:

Fixed idle time: adjustable in milliseconds

Dynamic dead time: the microcontroller constantly monitors the pulse sequence and eliminates multiple pulses even if the conveying speed varies by dynamically adjusting the dead time to the pulse sequence.

Synchronization to the machine cycle: the *SCATEC* can be synchronized to the machine cycle (e.g. by an encoder) via a synchronization input. The dead time then corresponds to a defined distance which is absolutely independent of the conveying speed.

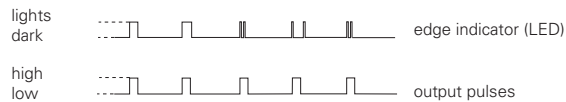
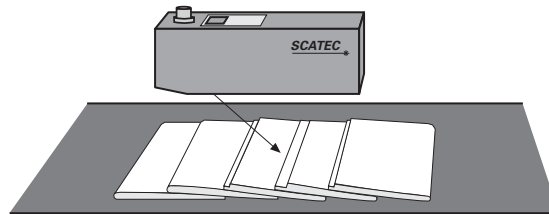

- No counting errors when the lap stream is interrupted

The *SCATEC* detects only the leading edge of an object. It does not detect trailing edges which become visible when the lap stream is interrupted. Projecting trailing edges can be suppressed by direct gap detection or by delaying the output pulse (*SCATEC-10* or *SCATEC-15*). An integrated retro-reflective sensor allows accurate detection of gaps in the lap stream. This can additionally increase the counting accuracy.

- Programming and diagnostic software

With the programming software *ScaDiag*, all functions and parameters can be simply adjusted on a PC. Furthermore, measurement sequences can be recorded and stored for diagnosis and troubleshooting.



Technology and operation

Stated simply, the **SCATEC** consists of a laser light source and two photodetectors. The beam is aimed diagonally at the objects to be detected.

The photodetector **R** is located close to the laser light source and photodetector **V** is a little further away. The sensor determines the ratio between signal **v** (light diffused forwards) and signal **r** (light diffused backwards).

The ratio **v/r** differs widely depending on whether the beam strikes a flat surface or an edge. If an edge moves into the laser beam, the direct view from detector **V** to the laser strike point is obstructed, reducing signal **v**, and also the edge increases the backwards diffusion, which causes signal **r** to rise. Both effects make the ratio **v/r** much smaller at an edge than on a flat surface. If the ratio **v/r** falls below a specific threshold, this is interpreted by the sensor as an edge.

Due to the well-focused laser beam, the **SCATEC** detects even the smallest edges. There is no blind region directly beneath the sensor. Large counted objects may even touch the sensor without causing counting errors.

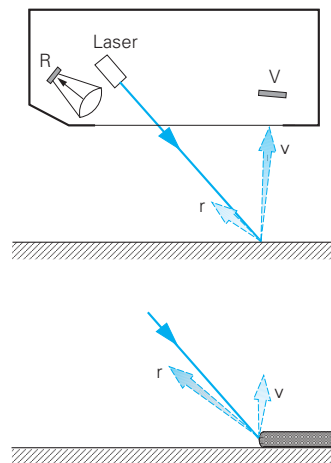

Mounting and adjustment

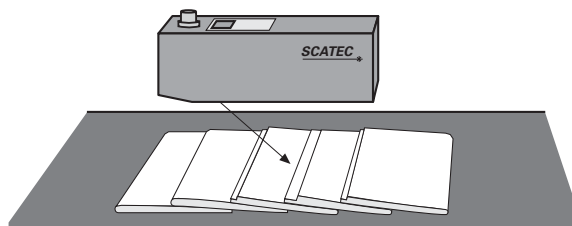

- The objects to be counted must have an edge facing the beam.
- The sensor must be installed parallel above the working plane.
- The laser beam should be blocked by a beam stop mounted parallel and just below the bearing surface. We recommend a light, matte object for this purpose (white paper, light and matte metal surface).

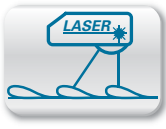

Sd = 0 ... 120 mm

- counting of up to 3 million copies/hour
- integrated copy counter
- encoder input

| general data | |
|----------------------------|--|
| measuring distance Sd | 0 ... 120 mm |
| optimum operating distance | 100 mm |
| counting rate | < 3'000'000,00 copies/h |
| object speed | < 5 m/sec |
| object cycle distance | > 1 mm |
| sensitivity | single sheet/edge thickness 0,15 mm |
| sync. input | yes |
| measuring point | visible red laser line 8 mm |
| light source | pulsed red laser diode |
| wave length | 670 nm |
| laser class | 2 |
| edge indicator | LED yellow |
| power on indication | LED green |
| false pulse suppression | 4 program options |
| direct gap detection | yes |
| sensitivity adjustment | 4 preset levels or level set by customer |

| electrical data | |
|------------------------------------|-----------------------------|
| voltage supply range +Vs | 10 ... 30 VDC |
| current consumption max. (no load) | 230 mA |
| output pulse length | 0,3 ... 500 ms selectable |
| short circuit protection | yes |
| reverse polarity protection | yes |
| interface | serial for ScaDiag software |

| mechanical data | |
|---------------------------------|------------------|
| width / diameter | 30 mm |
| type | rectangular |
| housing material | die-cast zinc |
| connector base (main connector) | DIN 45322, 6 pin |
| connector base (interface) | DIN 45326, 8 pin |
| front (optics) | glass |

| ambient conditions | |
|-----------------------|--------------|
| operating temperature | 0 ... +50 °C |
| protection class | IP 54 |

| order reference | output circuit |
|-------------------|----------------|
| FLDM 170C1030/S42 | opto isolated |
| FLDM 170G1030/S42 | push-pull |



connection diagrams

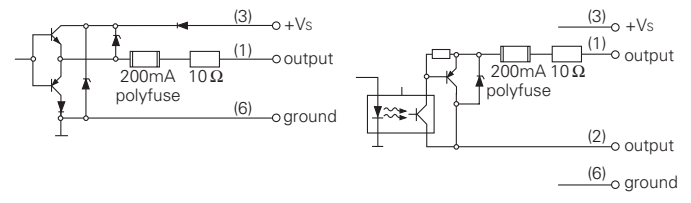

accessories

| | |
|--|----------|
| ScaDiag kit diagnostic program includes interface converter and manual | 10156491 |
| mounting plate for mounting on round rod | 10157472 |

for details, see accessories section

laser warning

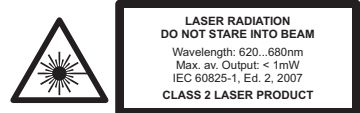

Complies with 21 CFR 1040.10 and 1040.11 except for deviations pursuant to laser notice No. 50, dated June 24, 2007

FLDM 170 Sd = 0 ... 120 mm

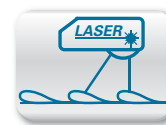

pin assignments

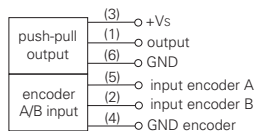

main connector push-pull

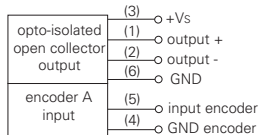

main connector open collector

connectors

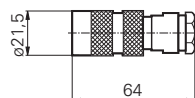

| | | |
|----------|-------|------------|
| 10104236 | 6 pin | (included) |
| 10153202 | 8 pin | (optional) |

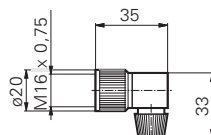

| | | |
|----------|-------|------------|
| 10153094 | 6 pin | (optional) |
| 10153095 | 8 pin | (optional) |

connector

ESG 16DP1000G main cable, length = 10 m, shielded, 6 pin

reflectors

| | |
|--------------|-----------------|
| FTDF 025F025 | tape 25 x 25 mm |
| (included) | |

dimension drawing

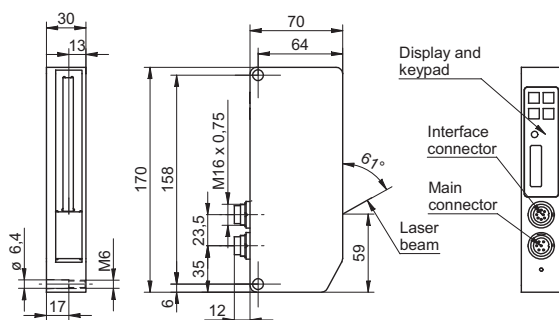

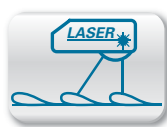

Sd = 0 ... 90 mm

- counting of up to 3 million copies/hour
- integrated copy counter

general data

| | |
|----------------------------|--|
| measuring distance Sd | 0 ... 90 mm |
| optimum operating distance | 70 mm |
| counting rate | < 3'000'000,00 copies/h |
| object speed | < 5 m/sec |
| object cycle distance | > 1 mm |
| sensitivity | single sheet/edge thickness 0,1 mm |
| sync. input | yes |
| measuring point | visible red laser line 6 mm |
| light source | pulsed red laser diode |
| wave length | 670 nm |
| laser class | 2 |
| edge indicator | LED yellow |
| power on indication | LED green |
| false pulse suppression | 4 program options |
| direct gap detection | yes |
| sensitivity adjustment | 4 preset levels or level set by customer |

electrical data

| | |
|------------------------------------|-----------------------------|
| voltage supply range +Vs | 10 ... 30 VDC |
| current consumption max. (no load) | 230 mA |
| output pulse length | 0,3 ... 500 ms selectable |
| short circuit protection | yes |
| reverse polarity protection | yes |
| interface | serial for ScaDiag software |

mechanical data

| | |
|---------------------------------|------------------|
| width / diameter | 30 mm |
| type | rectangular |
| housing material | die-cast zinc |
| connector base (main connector) | DIN 45322, 6 pin |
| connector base (interface) | DIN 45326, 8 pin |
| front (optics) | glass |

ambient conditions

| | |
|-----------------------|--------------|
| operating temperature | 0 ... +50 °C |
| protection class | IP 54 |

order reference output circuit

| | |
|-------------------|---------------|
| FLDM 170C1011/S42 | opto isolated |
| FLDM 170G1011/S42 | push-pull |



connection diagrams

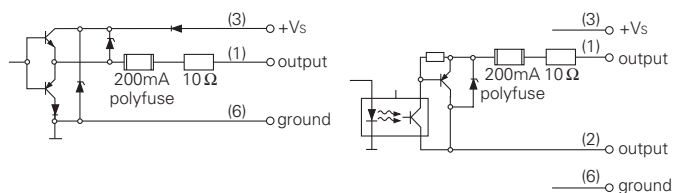

accessories

| | |
|--|----------|
| ScaDiag kit diagnostic program | 10156490 |
| includes interface converter and manual | |
| mounting plate for mounting on round rod | 10157472 |
| for details, see accessories section | |

laser warning

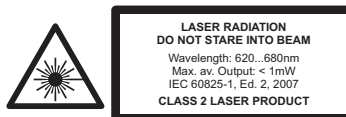

Complies with 21 CFR 1040.10 and 1040.11 except for deviations pursuant to laser notice No. 50, dated June 24, 2007

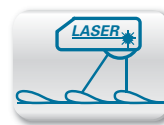

pin assignments

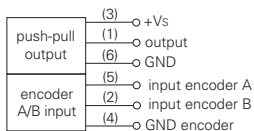

main connector push-pull

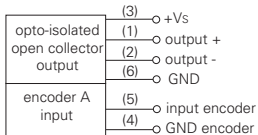

main connector open collector

connectors

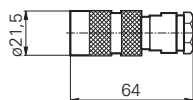

10104236 6 pin (included)

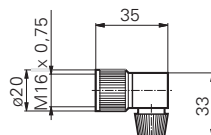

10153094 6 pin (optional)

connector

ESG 16DP1000G main cable, length = 10 m, shielded, 6 pin

reflectors

FTDF 025F025 tape 25 x 25 mm

(included)

dimension drawing

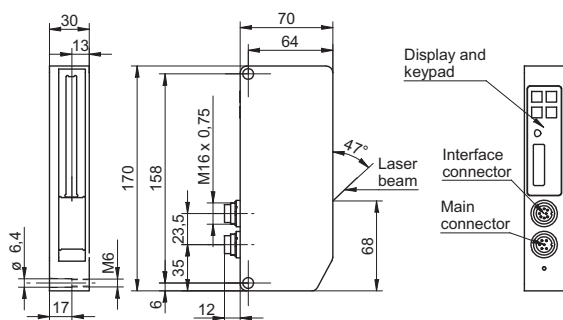

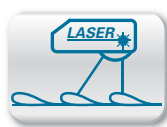

Sd = 0 ... 120 mm

- counting of up to 600'000 copies/hour
- standard connector M12x1
- compact design

general data

| | |
|-------------------------|------------------------|
| counting rate | < 600'000,00 copies/h |
| object speed | < 5 m/sec |
| object cycle distance | > 1 mm |
| sync. input | no |
| light source | pulsed red laser diode |
| wave length | 670 nm |
| laser class | 2 |
| edge indicator | LED yellow |
| power on indication | LED green |
| false pulse suppression | on/off switchable |

electrical data

| | |
|------------------------------------|--------------------------------|
| voltage supply range +Vs | 10 ... 30 VDC |
| current consumption max. (no load) | 180 mA |
| output pulse length | 5 / 10 / 15 / 20 ms selectable |
| short circuit protection | yes |
| reverse polarity protection | yes |

mechanical data

| | |
|------------------|-------------|
| width / diameter | 30 mm |
| type | rectangular |
| housing material | PA 6 |
| front (optics) | glass |

ambient conditions

| | |
|-----------------------|--------------|
| operating temperature | 0 ... +50 °C |
| protection class | IP 54 |



connection diagrams

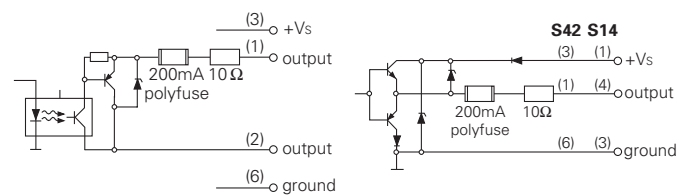

accessories

| | |
|---|----------|
| ScaDiag kit (S14) diagnostic program includes interface converter and manual | 10156479 |
| ScaDiag kit (S42) diagnostic program includes interface converter and manual | 10156489 |
| mounting plate for mounting on round rod for details, see accessories section | 10157472 |

laser warning



Complies with 21 CFR 1040.10 and 1040.11 except for deviations pursuant to laser notice No. 50, dated June 24, 2007

| order reference | measuring distance Sd | sensitivity | output circuit | optimum operating distance | measuring point | connector base (main connector) | sensitivity adjustment |
|-------------------|-----------------------|-------------------------------------|----------------|----------------------------|-----------------------------|---------------------------------|------------------------|
| FLDK 110C1003/S42 | 0 ... 60 mm | single sheet/edge thickness 0,2 mm | opto isolated | 40 mm | visible red laser line 2 mm | DIN 45322, 6 pin | high/low switchable |
| FLDK 110G1003/S14 | 0 ... 60 mm | single sheet/edge thickness 0,2 mm | push-pull | 40 mm | visible red laser line 2 mm | M12 x 1, 4 pin | high/low switchable |
| FLDK 110G1003/S42 | 0 ... 60 mm | single sheet/edge thickness 0,2 mm | push-pull | 40 mm | visible red laser line 2 mm | DIN 45322, 6 pin | high/low switchable |
| FLDK 110G1005/S14 | 0 ... 120 mm | single sheet/edge thickness 0,25 mm | push-pull | 100 mm | visible red laser line 3 mm | M12 x 1, 4 pin | - |

FLDK 110 Sd = 0 ... 120 mm

Laser copy counter SCATEC-2

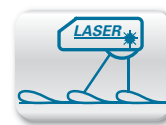

connectors

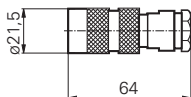

10104236 6 pin DIN 45322
(included)

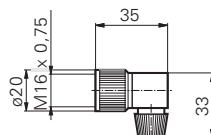

10153094 6 pin DIN 45322
(optional)

connectors M12 x 1

| | | |
|--------------|-------|----------------|
| ESG 34AH0200 | 4 pin | 2 m, straight |
| ESG 34AH0500 | 4 pin | 5 m, straight |
| ESG 34AH1000 | 4 pin | 10 m, straight |

connectors M12 x 1

| | | |
|--------------|-------|---------------|
| ESW 33AH0200 | 4 pin | 2 m, angular |
| ESW 33AH0500 | 4 pin | 5 m, angular |
| ESW 33AH1000 | 4 pin | 10 m, angular |

dimension drawings

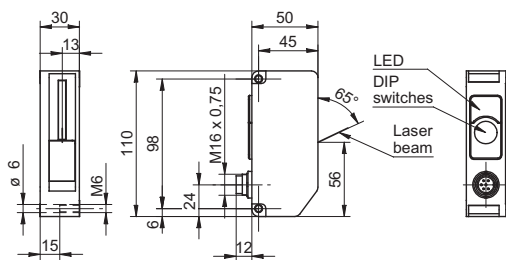

FLDK 110x1003/S42

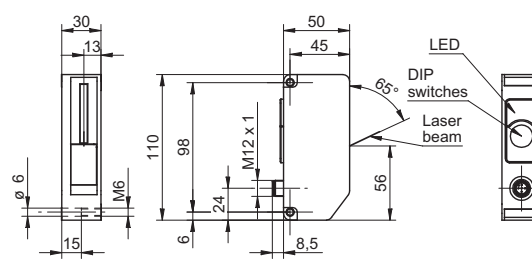

FLDK 110x1003/S14

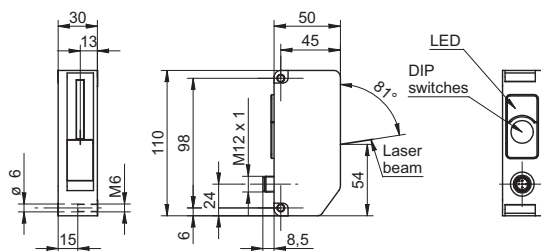

FLDK 110G1005/S14

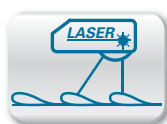

Sd = 0 ... 120 mm

- copy counting in conveyor clamps
- counts double copies
- synchronization input

general data

| | |
|----------------------------|--|
| measuring distance Sd | 0 ... 120 mm |
| optimum operating distance | 70 mm |
| object speed | < 5 m/sec |
| sensitivity | single sheet/edge thickness 0,25 mm |
| sync. input | yes |
| measuring point | visible red laser line 2 mm |
| light source | pulsed red laser diode |
| wave length | 650 nm |
| laser class | 2 |
| edge indicator | LED yellow |
| power on indication | LED green |

electrical data

| | |
|------------------------------------|---------------|
| voltage supply range +Vs | 10 ... 30 VDC |
| current consumption max. (no load) | 200 mA |
| output circuit | push-pull |
| short circuit protection | yes |
| reverse polarity protection | yes |

mechanical data

| | |
|---------------------------------|------------------|
| width / diameter | 30 mm |
| type | rectangular |
| housing material | PA 6 |
| connector base (main connector) | DIN 45326, 8 pin |
| front (optics) | glass |

ambient conditions

| | |
|-----------------------|--------------|
| operating temperature | 0 ... +50 °C |
| protection class | IP 54 |

order reference

FLDK 110G1903/S42



connection diagram

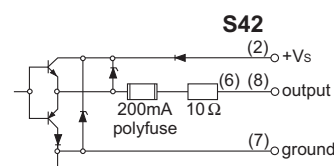

accessories

| | |
|--|----------|
| mounting plate for mounting on round rod | 10157472 |
| ScaDiag kit diagnostic program includes interface converter and manual | 11051709 |
| for details, see accessories section | |

laser warning



Complies with 21 CFR 1040.10 and 1040.11 except for deviations pursuant to laser notice No. 50, dated June 24, 2007

FLDK 110 Sd = 0 ... 120 mm

Laser copy counter SCATEC-2 Gripper

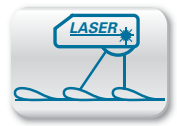

connectors

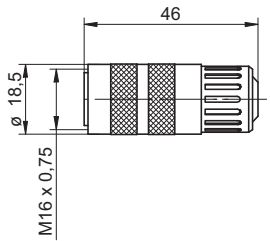

10153202 8 pin DIN 45322
(included)

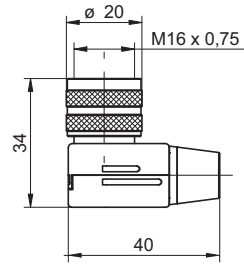

10153095 8 pin DIN 45322
(optional)

dimension drawing

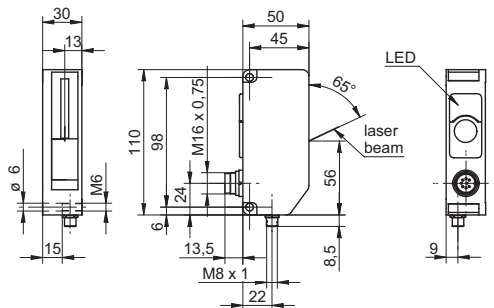

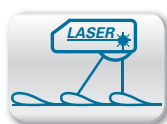

Sd = 0 ... 120 mm

- counting boxes in a row
- counting of up to 600'000 boxes/hour
- compact design

general data

| | |
|----------------------------|--|
| measuring distance Sd | 0 ... 120 mm |
| optimum operating distance | 100 mm |
| counting rate | < 600'000,00 copies/h |
| object speed | < 5 m/sec |
| sensitivity | single sheet/edge thickness 0,25 mm |
| sync. input | no |
| measuring point | visible red laser line 3 mm |
| light source | pulsed red laser diode |
| wave length | 670 nm |
| laser class | 2 |
| edge indicator | LED yellow |
| power on indication | LED green |
| false pulse suppression | on/off switchable |

electrical data

| | |
|------------------------------------|----------------------|
| voltage supply range +Vs | 10 ... 30 VDC |
| current consumption max. (no load) | 180 mA |
| output circuit | push-pull |
| output pulse length | 5 / 10 ms selectable |
| short circuit protection | yes |
| reverse polarity protection | yes |

mechanical data

| | |
|---------------------------------|----------------|
| width / diameter | 30 mm |
| type | rectangular |
| housing material | PA 6 |
| connector base (main connector) | M12 x 1, 4 pin |
| front (optics) | glass |

ambient conditions

| | |
|-----------------------|--------------|
| operating temperature | 0 ... +50 °C |
| protection class | IP 54 |

order reference

FLDK 110G1006/S14



connection diagram

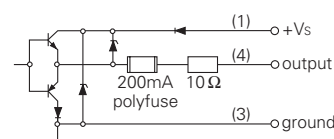

accessories

| | |
|--|----------|
| mounting plate for mounting on round rod | 10157472 |
| ScaDiag kit diagnostic program includes interface converter and manual | 10156479 |

for details, see accessories section

laser warning



Complies with 21 CFR 1040.10 and 1040.11 except for deviations pursuant to laser notice No. 50, dated June 24, 2007

FLDK 110 Sd = 0 ... 120 mm

Laser copy counter SCATEC-2 Box

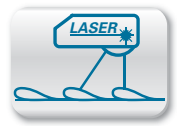

connectors

| connectors M12 x 1 | | |
|--------------------|-------|----------------|
| ESG 34AH0200 | 4 pin | 2 m, straight |
| ESG 34AH0500 | 4 pin | 5 m, straight |
| ESG 34AH1000 | 4 pin | 10 m, straight |

| connectors M12 x 1 | | |
|--------------------|-------|---------------|
| ESW 33AH0200 | 4 pin | 2 m, angular |
| ESW 33AH0500 | 4 pin | 5 m, angular |
| ESW 33AH1000 | 4 pin | 10 m, angular |

dimension drawing

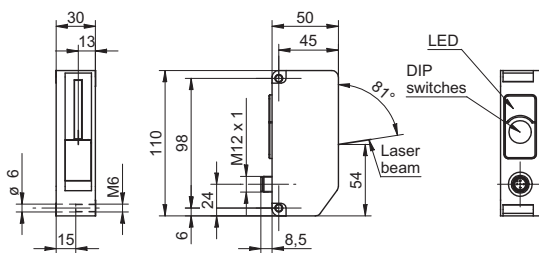

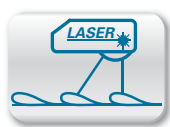

Sd = 0 ... 55 mm

- Plug & Play
- counting of up to 280'000 copies/hour
- compact design

general data

| | |
|----------------------------|---------------------------------------|
| measuring distance Sd | 0 ... 55 mm |
| optimum operating distance | 40 mm |
| counting rate | < 280'000,00 copies/h |
| object speed | < 2 m/sec |
| object cycle distance | > 13 mm |
| sensitivity | single sheet/edge thickness 1,5 mm |
| sync. input | no |
| measuring point | visible red point |
| light source | pulsed red laser diode |
| wave length | 670 nm |
| laser class | 2 |
| edge indicator | LED yellow |
| power on indication | LED green |
| sensitivity adjustment | no |

electrical data

| | |
|------------------------------------|---------------|
| voltage supply range +Vs | 10 ... 30 VDC |
| current consumption max. (no load) | 180 mA |
| output circuit | push-pull |
| output pulse length | 10 ms |
| short circuit protection | yes |
| reverse polarity protection | yes |

mechanical data

| | |
|---------------------------------|----------------|
| width / diameter | 30 mm |
| type | rectangular |
| housing material | PA 6 |
| connector base (main connector) | M12 x 1, 4 pin |
| front (optics) | glass |

ambient conditions

| | |
|-----------------------|--------------|
| operating temperature | 0 ... +50 °C |
| protection class | IP 54 |

order reference

FLDK 110G1010/S14



connection diagram

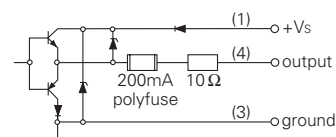

accessories

| | |
|--|----------|
| mounting plate for mounting on round rod | 10157472 |
| ScaDiag kit diagnostic program includes interface converter and manual | 11051709 |

for details, see accessories section

laser warning

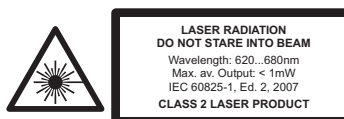

Complies with 21 CFR 1040.10 and 1040.11 except for deviations pursuant to laser notice No. 50, dated June 24, 2007

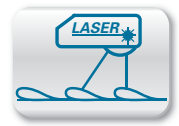

connectors

| connectors M12 x 1 | | |
|--------------------|-------|----------------|
| ESG 34AH0200 | 4 pin | 2 m, straight |
| ESG 34AH0500 | 4 pin | 5 m, straight |
| ESG 34AH1000 | 4 pin | 10 m, straight |

| connectors M12 x 1 | | |
|--------------------|-------|---------------|
| ESW 33AH0200 | 4 pin | 2 m, angular |
| ESW 33AH0500 | 4 pin | 5 m, angular |
| ESW 33AH1000 | 4 pin | 10 m, angular |

dimension drawing

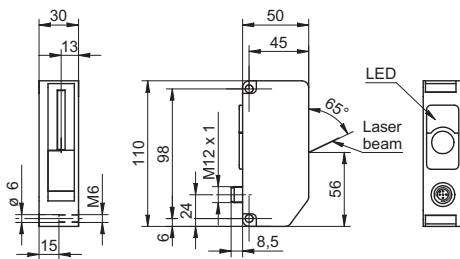



Color/Contrast recognition

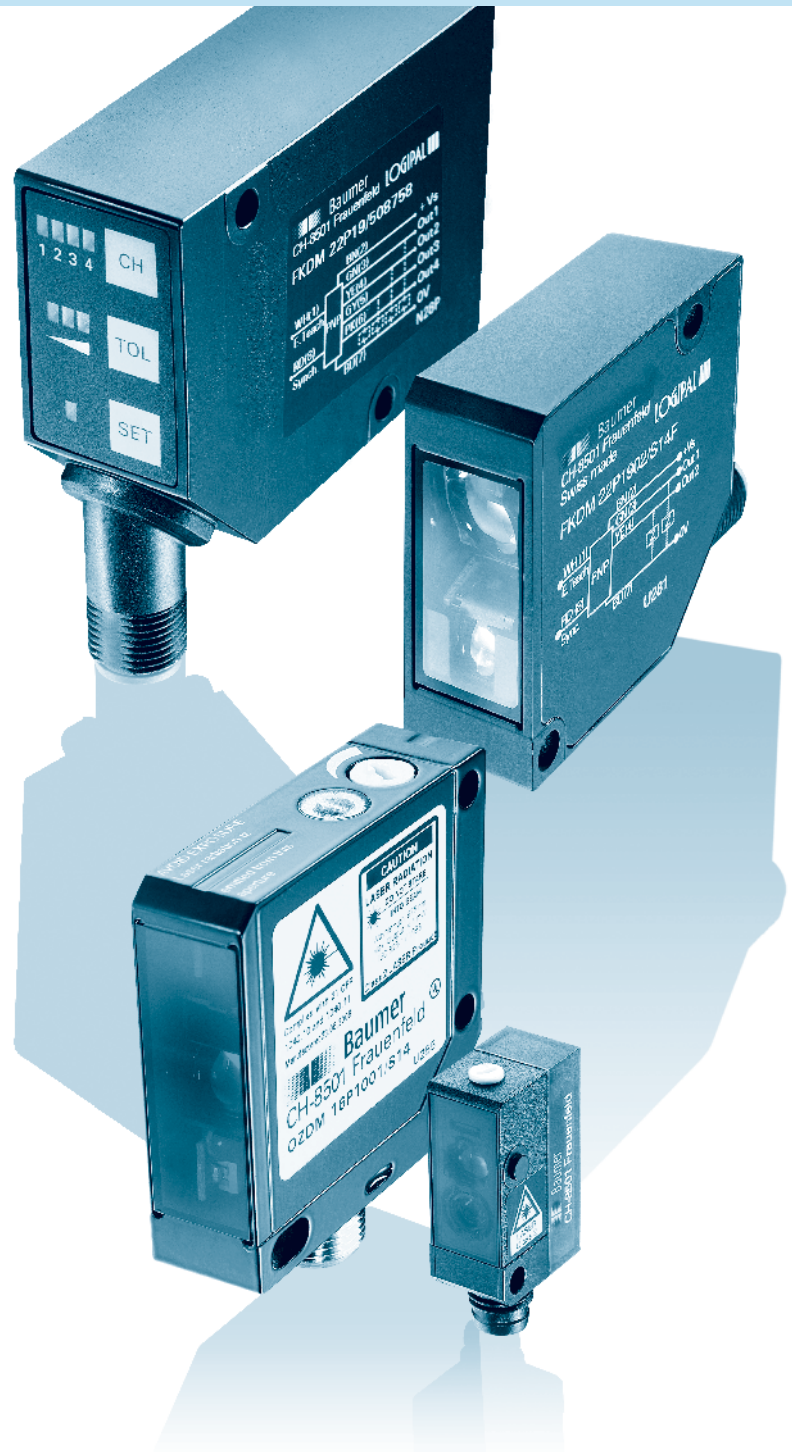



Color sensors *LOGIPAL*

Diffuse laser sensors for contrast detection

Page 398

Page 404

| product family | FKDM 22 | FKDM 22 | FKDM 22 |
|------------------------------|---|---|--|
| |  |  |  |
| | <i>LOGIPAL</i> | <i>LOGIPAL</i> | <i>LOGIPAL</i> |
| sensing distance Tw | 40 mm | 40 mm | 25 mm |
| sensor channels | 4 (teachable) | 2 (teachable) | 4 (teachable) |
| size of measuring spot | 3 mm x 5 mm | 3 mm x 5 mm | 0,7 mm x 1,3 mm |
| response time / release time | < 0,34 ms | < 0,34 ms | < 0,34 ms |
| NPN | ■ | ■ | ■ |
| PNP | ■ | ■ | ■ |
| device plug | connector M12, 8 pin, rotatable | connector M12, 8 pin, rotatable | connector M12, 8 pin, rotatable |
| | | | |
| page | 400 | 401 | 402 |



General information

With the **LOGIPAL** color detection sensor, you can now use the color as a solution for sorting, quality monitoring and automation in your processes.

Applications

- Objects can be monitored and sorted by colored marks.
- The correct color of objects can be inspected or the objects can be sorted by their color.

Characteristics and advantages

- **Simple operation:**
Four different colors can be programmed with just three buttons.
- **Finest color graduation:**
One of five tolerance stages can be chosen for each color.
- **Short response time:**
With a response time of only 0.34 ms, high detection rates can be achieved.
- **Synchronization input:**
Allows controlled measurement of the color.
- **External Teach-in input:**
Allows complete remote control of all Teach-in functions by serial data transfer. An RS 232 interface transducer with galvanic isolation is available as an accessory.

Technology and operation

The sensor operates by the three-stage principle, meaning that it emits the three colors red, green and blue and then measures the color proportions of the three colors reflected by the object.

The color of an object is programmed in the Teach-in procedure. If the sensor recognizes this color again during operation, it activates the corresponding output. Optional tolerances permit it to detect large or small differences in color.

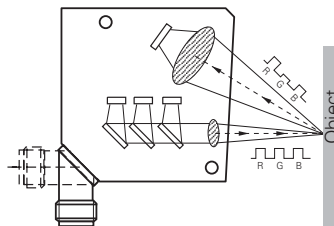

Mounting and adjustment

The use of the color sensor is as simple as for a diffuse sensor. Only the points below must be observed.

- For glossy objects, tilt the sensor to the side by approx. 15 °.
- If you wish to detect very fine differences in color, the sensing distance of 40 mm has to be adhered to.

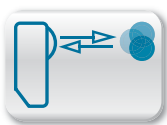

Tw = 40 mm

- up to 4 colors can be distinguished properly
- spot size 3 x 5 mm
- rugged metal housing



general data

| | |
|------------------------|-------------------------|
| sensing distance Tw | 40 mm |
| sensor channels | 4 (teachable) |
| tolerance ranges | 5-step teachable (LEDs) |
| size of measuring spot | 3 mm x 5 mm |
| light source | LED red / green / blue |
| signal display (Teach) | LED orange |
| channel status display | LED yellow per channel |
| power on indication | LED green |

electrical data

| | |
|------------------------------|--|
| response time / release time | < 0,34 ms |
| voltage supply range +Vs | 10 ... 30 VDC |
| power consumption | < 2 W |
| voltage drop Vd | < 1,8 VDC |
| output current (per channel) | < 100 mA |
| remote Teach-In input | protocol with return signal through channel 1-output |
| level (sync., teach) | high: 2/3 Vs...Vs low: 0 V...1/3 Vs |
| short circuit protection | yes |
| reverse polarity protection | yes |

mechanical data

| | |
|------------------|---------------------------------|
| width / diameter | 22,9 mm |
| type | rectangular |
| housing material | die-cast zinc |
| front (optics) | glass |
| device plug | connector M12, 8 pin, rotatable |

ambient conditions

| | |
|-----------------------|----------------|
| operating temperature | -10 ... +55 °C |
| protection class | IP 67 |

connectors

| | | |
|---------------|-------|-------------------------|
| ESG 34FP0200B | 8 pin | 2 m straight (shielded) |
| ESG 34FP0500B | 8 pin | 5 m straight (shielded) |

additional cable connectors and field wireable connectors, see accessories

accessories

| | |
|------------------|----------|
| mounting bracket | 10126220 |
| converter RS 232 | 10134596 |

for details, see accessories section

remarks

Complete remote control of the sensor is possible using the "Ext. Teach" input. The converter RS 232 is necessary.

dimension drawing

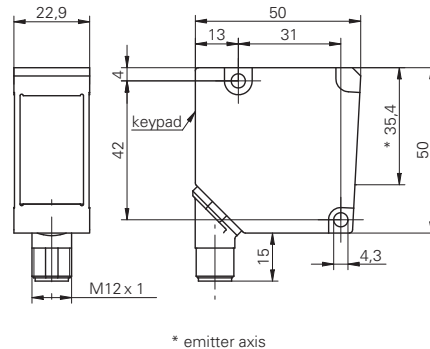

* emitter axis

connection diagrams

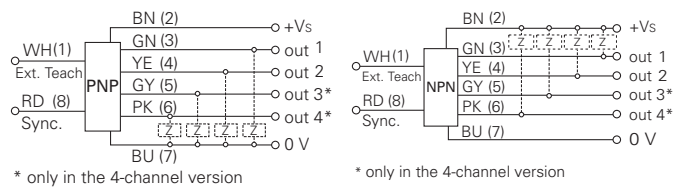

* only in the 4-channel version

* only in the 4-channel version

| order reference | output circuit | output function | sync. input |
|-------------------|----------------|-----------------|-------------|
| FKDM 22N1901/S14F | NPN | light operate | high active |
| FKDM 22P1901/S14F | PNP | light operate | low active |
| FKDM 22P3901/S14F | PNP | dark operate | low active |

FKDM 22 Tw = 40 mm

Color sensors LOGIPAL

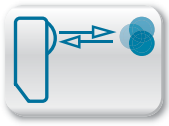

Tw = 40 mm

- up to 2 colors can be distinguished properly
- spot size 3 x 5 mm
- rugged metal housing



general data

| | |
|------------------------|-------------------------|
| sensing distance Tw | 40 mm |
| sensor channels | 2 (teachable) |
| tolerance ranges | 5-step teachable (LEDs) |
| size of measuring spot | 3 mm x 5 mm |
| light source | LED red / green / blue |
| signal display (Teach) | LED orange |
| channel status display | LED yellow per channel |
| power on indication | LED green |

electrical data

| | |
|------------------------------|--|
| response time / release time | < 0,34 ms |
| voltage supply range +Vs | 10 ... 30 VDC |
| power consumption | < 2 W |
| voltage drop Vd | < 1,8 VDC |
| output current (per channel) | < 100 mA |
| remote Teach-In input | protocol with return signal through channel 1-output |
| level (sync., teach) | high: 2/3 Vs...Vs low: 0 V...1/3 Vs |
| short circuit protection | yes |
| reverse polarity protection | yes |

mechanical data

| | |
|------------------|---------------------------------|
| width / diameter | 22,9 mm |
| type | rectangular |
| housing material | die-cast zinc |
| front (optics) | glass |
| device plug | connector M12, 8 pin, rotatable |

ambient conditions

| | |
|-----------------------|----------------|
| operating temperature | -10 ... +55 °C |
| protection class | IP 67 |

connectors

| | | |
|---------------|-------|-------------------------|
| ESG 34FP0200B | 8 pin | 2 m straight (shielded) |
| ESG 34FP0500B | 8 pin | 5 m straight (shielded) |

additional cable connectors and field wireable connectors, see accessories

accessories

| | |
|------------------|----------|
| mounting bracket | 10126220 |
| converter RS 232 | 10134596 |

for details, see accessories section

remarks

Complete remote control of the sensor is possible using the "Ext. Teach" input. The converter RS 232 is necessary.

dimension drawing

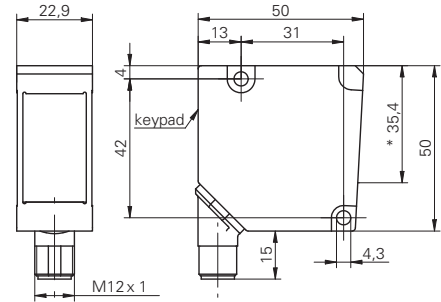

* emitter axis

connection diagrams

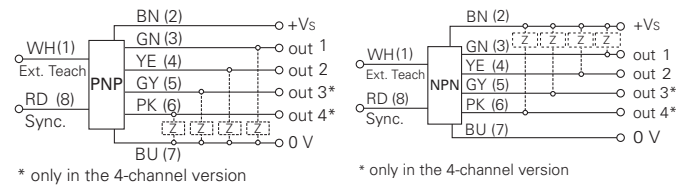

* only in the 4-channel version

* only in the 4-channel version

| order reference | output circuit | output function | sync. input |
|-------------------|----------------|-----------------|-------------|
| FKDM 22N1902/S14F | NPN | light operate | high active |
| FKDM 22P1902/S14F | PNP | light operate | low active |
| FKDM 22P3902/S14F | PNP | dark operate | low active |

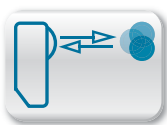

Tw = 25 mm

- up to 4 colors can be distinguished properly
- spot size 0,7 x 1,3 mm
- rugged metal housing



general data

| | |
|------------------------|-------------------------|
| sensing distance Tw | 25 mm |
| sensor channels | 4 (teachable) |
| tolerance ranges | 5-step teachable (LEDs) |
| size of measuring spot | 0,7 mm x 1,3 mm |
| light source | LED red / green / blue |
| signal display (Teach) | LED orange |
| channel status display | LED yellow per channel |
| power on indication | LED green |

electrical data

| | |
|------------------------------|--|
| response time / release time | < 0,34 ms |
| voltage supply range +Vs | 10 ... 30 VDC |
| power consumption | < 2 W |
| output function | light operate |
| voltage drop Vd | < 1,8 VDC |
| output current (per channel) | < 100 mA |
| remote Teach-In input | protocol with return signal through channel 1-output |
| level (sync., teach) | high: 2/3 Vs...Vs low: 0 V...1/3 Vs |
| short circuit protection | yes |
| reverse polarity protection | yes |

mechanical data

| | |
|------------------|---------------------------------|
| width / diameter | 22,9 mm |
| type | rectangular |
| housing material | aluminum anodized |
| front (optics) | glass |
| device plug | connector M12, 8 pin, rotatable |

ambient conditions

| | |
|-----------------------|----------------|
| operating temperature | -10 ... +55 °C |
| protection class | IP 67 |

connectors

| | | |
|---------------|-------|-------------------------|
| ESG 34FP0200B | 8 pin | 2 m straight (shielded) |
| ESG 34FP0500B | 8 pin | 5 m straight (shielded) |

additional cable connectors and field wireable connectors, see accessories

accessories

| | |
|------------------|----------|
| mounting bracket | 10126220 |
| converter RS 232 | 10134596 |

for details, see accessories section

remarks

Complete remote control of the sensor is possible using the "Ext. Teach" input. The converter RS 232 is necessary.

| order reference | output circuit | sync. input |
|-------------------|----------------|-------------|
| FKDM 22N1911/S14F | NPN | high active |
| FKDM 22P1911/S14F | PNP | low active |

dimension drawing

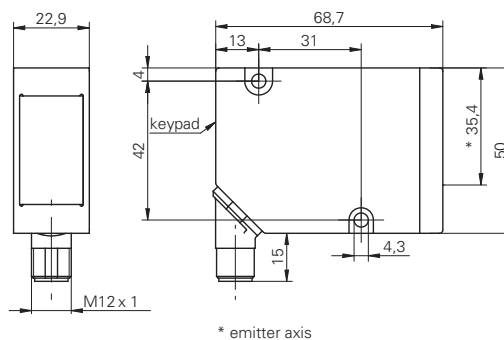

connection diagrams

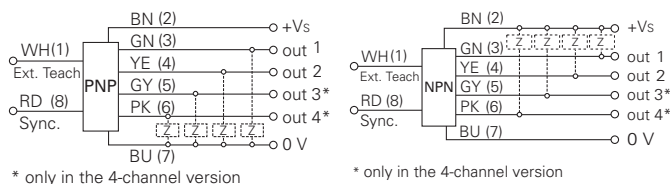

* only in the 4-channel version

* only in the 4-channel version

FKDM 22 Tw = 25 mm

Color sensors LOGIPAL

white light version

| | |
|---|-------------------------|
| product family | FKDK 14 |
|  | |
| type | diffuse contrast sensor |
| width / diameter | 14,8 mm |
| sensing distance Tw | 12,5 mm ±2 mm |
| response time / release time | < 0,05 ms |
| sensitivity adjustment | Teach-in |
| push-pull | ■ |
| cable | ■ |
| connector | ■ |
| housing material | plastic |
| page | 406 |

laser version

| product family | OZDK 10 | OZDK 10 | OZDK 14 | OZDM 16 | OZDM 16 |
|--|-------------------------|-------------------------|-------------------------|-------------------------|-------------------------|
|  | | | | | |
| type | diffuse contrast sensor | diffuse contrast sensor | diffuse contrast sensor | diffuse contrast sensor | diffuse contrast sensor |
| width / diameter | 10,4 mm | 10,4 mm | 14,8 mm | 15,4 mm | 15,4 mm |
| sensing distance Tw | 3 ... 150 mm | 3 ... 150 mm | 20 ... 300 mm | 0 ... 250 mm | 0 ... 250 mm |
| response time / release time | < 0,05 ms | < 0,05 ms | < 0,15 ms | < 0,1 ms | < 0,05 ms |
| sensitivity adjustment | potentiometer, 5 turn | potentiometer, 5 turn | Teach-in | potentiometer, 14 turn | potentiometer, 14 turn |
| NPN | ■ | ■ | ■ | ■ | ■ |
| PNP | ■ | ■ | ■ | ■ | ■ |
| cable | ■ | ■ | ■ | ■ | ■ |
| connector | ■ | ■ | ■ | ■ | ■ |
| housing material | plastic | plastic | plastic | metal | metal |
| page | 408 | 410 | 412 | 414 | 416 |



General information

Diffuse contrast sensors can detect finest differences in contrast. Contrasts arise when surfaces bear bright and dark areas (e.g. a dark color mark on a bright primary color), or by structures on a surface (e.g. a weld seam).

Applications

- **Recognize print marks (FKDK 14)**
Print marks (or color marks) are usually dark-colored marks on a light background. The marks differ from the background in brightness and often in color.
- **Detect edges, seams, grooves (laser sensors)**
If a surface is observed from an oblique angle, the reflection behavior changes at an indentation, which to the sensor is equivalent to a contrast difference.

Characteristics and advantages

- White light sensor
The narrow white light line allows precise detection of color marks
- Laser sensors
Thanks to the focused beam, even the slightest edge up to 0.1 mm in height can be detected.
- Fast response time
Very short response times up to 50 μ s allow "real time" recording of marks and thus increase the process accuracy.
- Sensor with analog signal
Allows to import desired nominal values and to detect deviations thereof.

Technology and operation

Diffuse contrast sensors are based on the intensity difference principle with a clearly defined small light spot. At the ideal operating distance the sensor is optimized so that the finest contrast differences are detected almost independent of small changes in distance.

The graph "Relative signal reception" was measured on white paper.

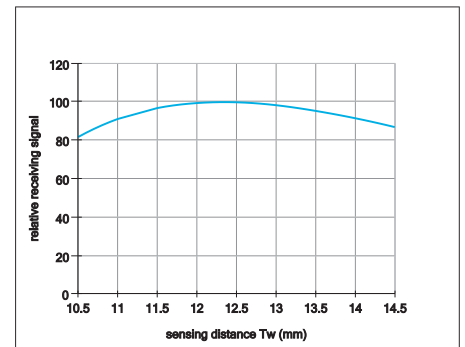

Mounting and adjustment

The sensor should usually be mounted inclined by 5° to 20° to the object surface, especially when shiny material is scanned. When scanning edges, grooves or indentations, the sensor must be aligned so that the direct reflection is detected when the indentation, groove, or edge enters the light beam.

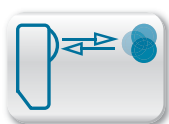

Tw = 12.5 mm

- very short response time
- white light

general data

| | |
|------------------------|-------------------------|
| type | diffuse contrast sensor |
| light source | white LED |
| sensing distance Tw | 12,5 mm ±2 mm |
| light indicator | LED green |
| output indicator | LED yellow |
| sensitivity adjustment | Teach-in |
| distance to focus | 12,5 mm |
| beam height | 3 mm |
| beam width | 1 mm |

electrical data

| | |
|------------------------------------|----------------------|
| response time / release time | < 0,05 ms |
| voltage supply range +Vs | 18 ... 30 VDC |
| current consumption max. (no load) | 50 mA |
| current consumption typ. | 40 mA |
| voltage drop Vd | < 3 VDC |
| output function | light / dark operate |
| output circuit | push-pull |
| output current | < 100 mA |
| short circuit protection | yes |
| reverse polarity protection | yes |

mechanical data

| | |
|------------------|---------------------|
| width / diameter | 14,8 mm |
| height / length | 43 mm |
| depth | 31 mm |
| type | rectangular |
| housing material | plastic (ASA, MABS) |
| front (optics) | PMMA |

ambient conditions

| | |
|-----------------------|----------------|
| operating temperature | -25 ... +65 °C |
| protection class | IP 67 |

order reference

| order reference | connection types |
|-------------------|---------------------|
| FKDK 14G6901 | cable 4 pin, 2 m |
| FKDK 14G6901/S14 | connector M12 4 pin |
| FKDK 14G6901/S35A | connector M8 4 pin |

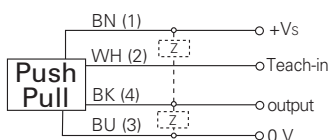
**connection diagram****connectors**

| | | |
|--------------|-------|--------------|
| ESG 32AH0200 | 4 pin | 2 m straight |
| ESW 31AH0200 | 4 pin | 2 m angular |

additional cable connectors and field wireable connectors, see accessories

accessories

| | |
|-----------------------|----------|
| SENSOFIX mounting kit | 10149011 |
| mounting bracket | 10134964 |

for details, see accessories section

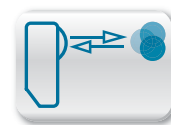

relative receiving signal

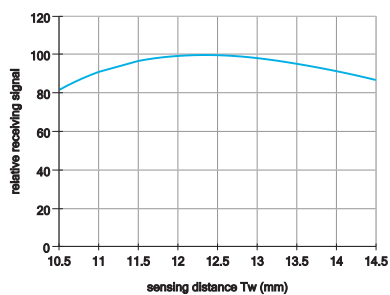

dimension drawings

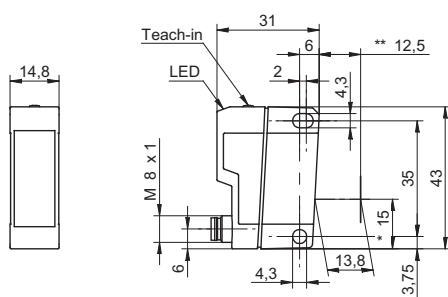

* emitter axis

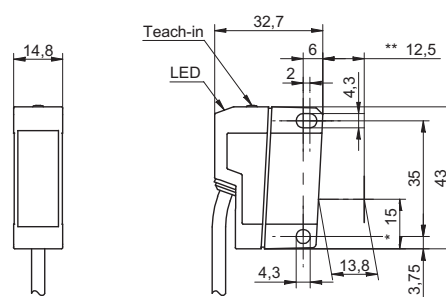

* emitter axis

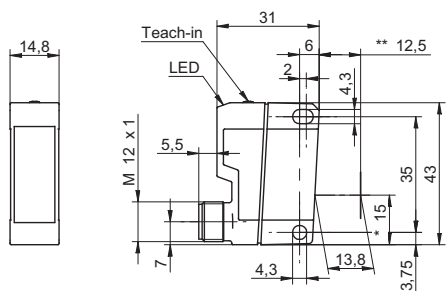

* emitter axis

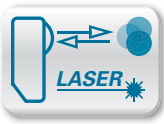

Tw = 3 ... 150 mm

- compact housing
- high repeatability
- very short response time

general data

| | |
|----------------------------|-------------------------|
| type | diffuse contrast sensor |
| version | line beam |
| light source | pulsed red laser diode |
| sensing distance Tw | 3 ... 150 mm |
| optimum operating distance | 35 ... 45 mm |
| repeat accuracy | < 0,2 mm at laser focus |
| power on indication | LED green |
| light indicator | LED yellow |
| sensitivity adjustment | potentiometer, 5 turn |
| laser class | 1 |
| distance to focus | 40 mm |
| wave length | 650 nm |

electrical data

| | |
|------------------------------------|----------------------|
| response time / release time | < 0,05 ms |
| voltage supply range +Vs | 10 ... 30 VDC |
| current consumption max. (no load) | 50 mA |
| current consumption typ. | 40 mA |
| voltage drop Vd | < 1,8 VDC |
| output function | light / dark operate |
| output current | < 100 mA |
| short circuit protection | yes |
| reverse polarity protection | yes |

mechanical data

| | |
|------------------|---------------|
| width / diameter | 10,4 mm |
| height / length | 27 mm |
| depth | 16,3 mm |
| type | rectangular |
| housing material | plastic (ASA) |
| front (optics) | PMMA |

ambient conditions

| | |
|-----------------------|----------------|
| operating temperature | -10 ... +50 °C |
|-----------------------|----------------|



connection diagrams



connectors

| | | |
|--------------|-------|--------------|
| ESG 32AH0200 | 4 pin | 2 m straight |
| ESW 31AH0200 | 4 pin | 2 m angular |

additional cable connectors and field wireable connectors, see accessories

accessories

| | |
|-----------------------------------|----------|
| SENSOFIX mounting kit | 10150326 |
| mounting bracket (cable type) | 10114501 |
| mounting bracket (connector type) | 10133792 |

for details, see accessories section

laser warning



Complies with 21 CFR 1040.10 and 1040.11 except for deviations pursuant to laser notice No. 50, dated June 24, 2007

| order reference | connection types | output circuit | protection class |
|-------------------|--------------------|----------------|------------------|
| OZDK 10N5150 | cable 4 pin, 2 m | NPN | IP 65 |
| OZDK 10N5150/S35A | connector M8 4 pin | NPN | IP 67 |
| OZDK 10P5150 | cable 4 pin, 2 m | PNP | IP 65 |
| OZDK 10P5150/S35A | connector M8 4 pin | PNP | IP 67 |

OZDK 10 Tw = 3 ... 150 mm

Diffuse contrast sensors

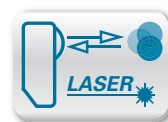

relative receiving signal

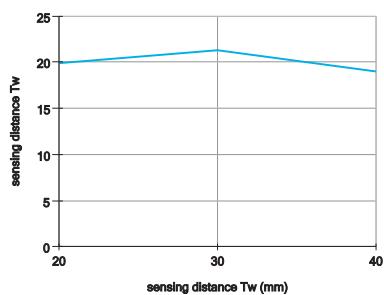

beam characteristic (typically)

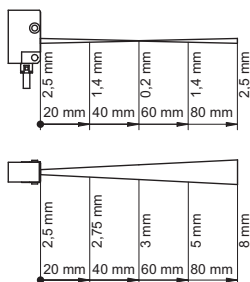

dimension drawings

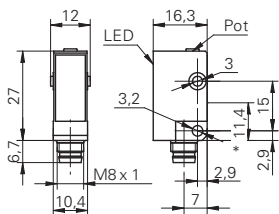

* emitter axis

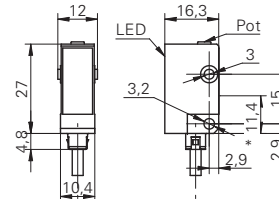

* emitter axis

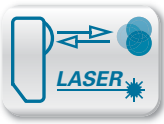

Tw = 3 ... 150 mm

- compact housing
- high repeatability
- very short response time

general data

| | |
|---|-------------------------|
| type | diffuse contrast sensor |
| light source | pulsed red laser diode |
| sensing distance Tw | 3 ... 150 mm |
| optimum operating distance | 20 ... 40 mm |
| detectable remission difference (on grey) | > 8 % |
| repeat accuracy | < 0,2 mm at laser focus |
| power on indication | LED green |
| light indicator | LED yellow |
| sensitivity adjustment | potentiometer, 5 turn |
| laser class | 2 |
| distance to focus | 40 mm |
| wave length | 650 nm |

electrical data

| | |
|------------------------------------|----------------------|
| response time / release time | < 0,05 ms |
| voltage supply range +Vs | 10 ... 30 VDC |
| current consumption max. (no load) | 50 mA |
| current consumption typ. | 40 mA |
| voltage drop Vd | < 1,8 VDC |
| output function | light / dark operate |
| output current | < 100 mA |
| short circuit protection | yes |
| reverse polarity protection | yes |

mechanical data

| | |
|------------------|---------------|
| width / diameter | 10,4 mm |
| height / length | 27 mm |
| depth | 16,3 mm |
| type | rectangular |
| housing material | plastic (ASA) |
| front (optics) | PMMA |

ambient conditions

| | |
|-----------------------|----------------|
| operating temperature | -10 ... +50 °C |
|-----------------------|----------------|



connection diagrams



connectors

| | | |
|--------------|-------|--------------|
| ESG 32AH0200 | 4 pin | 2 m straight |
| ESW 31AH0200 | 4 pin | 2 m angular |

additional cable connectors and field wireable connectors, see accessories

accessories

| | |
|-----------------------------------|----------|
| SENSOFIX mounting kit | 10150326 |
| mounting bracket (cable type) | 10114501 |
| mounting bracket (connector type) | 10133792 |

for details, see accessories section

laser warning

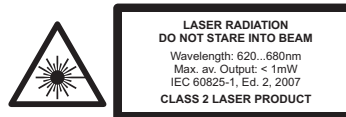

Complies with 21 CFR 1040.10 and 1040.11 except for deviations pursuant to laser notice No. 50, dated June 24, 2007

| order reference | connection types | output circuit | protection class |
|-------------------|--------------------|----------------|------------------|
| OZDK 10N5101 | cable 4 pin, 2 m | NPN | IP 65 |
| OZDK 10N5101/S35A | connector M8 4 pin | NPN | IP 67 |
| OZDK 10P5101 | cable 4 pin, 2 m | PNP | IP 65 |
| OZDK 10P5101/S35A | connector M8 4 pin | PNP | IP 67 |

OZDK 10 Tw = 3 ... 150 mm

Diffuse contrast sensors

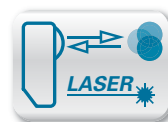

relative receiving signal

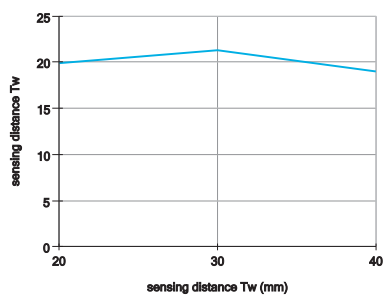

beam characteristic (typically)

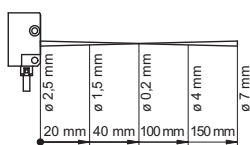

dimension drawings

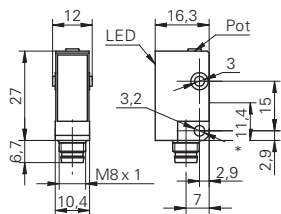

* emitter axis

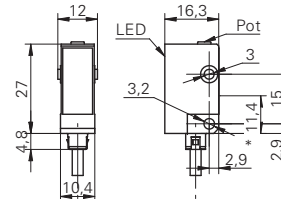

* emitter axis

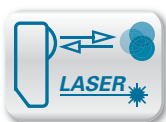

Tw = 20 ... 300 mm

- very short response time
- high repeatability
- sensing distance adjustable via Teach-in

general data

| | |
|-----------------------------------|--------------------------|
| type | diffuse contrast sensor |
| light source | pulsed red laser diode |
| sensing distance Tw | 20 ... 300 mm |
| optimum operating distance | 40 ... 60 mm |
| repeat accuracy | < 0,2 mm at laser focus |
| alignment / soiled lens indicator | flashing light indicator |
| power on indication | LED green |
| light indicator | LED yellow |
| sensitivity adjustment | Teach-in |
| laser class | 2 |
| distance to focus | 115 mm |
| wave length | 650 nm |

electrical data

| | |
|------------------------------------|---------------|
| response time / release time | < 0,15 ms |
| voltage supply range +Vs | 10 ... 30 VDC |
| current consumption max. (no load) | 35 mA |
| current consumption typ. | 25 mA |
| voltage drop Vd | < 2,2 VDC |
| output function | light operate |
| output current | < 100 mA |
| short circuit protection | yes |
| reverse polarity protection | yes |

mechanical data

| | |
|------------------|---------------------|
| width / diameter | 14,8 mm |
| height / length | 43 mm |
| depth | 31 mm |
| type | rectangular |
| housing material | plastic (ASA, MABS) |
| front (optics) | PMMA |

ambient conditions

| | |
|-----------------------|----------------|
| operating temperature | -10 ... +50 °C |
| protection class | IP 67 |

| order reference | connection types | output circuit |
|-------------------|---------------------|----------------|
| OZDK 14N1901 | cable 4 pin, 2 m | NPN |
| OZDK 14N1901/S14 | connector M12 4 pin | NPN |
| OZDK 14N1901/S35A | connector M8 4 pin | NPN |
| OZDK 14P1901 | cable 4 pin, 2 m | PNP |
| OZDK 14P1901/S14 | connector M12 4 pin | PNP |
| OZDK 14P1901/S35A | connector M8 4 pin | PNP |

**connection diagrams****connectors**

| | | |
|--------------|-------|--------------|
| ESG 32AH0200 | 4 pin | 2 m straight |
| ESW 31AH0200 | 4 pin | 2 m angular |

additional cable connectors and field wireable connectors, see accessories

accessories

| | |
|-----------------------|----------|
| SENSOFIX mounting kit | 10149011 |
| mounting bracket | 10134964 |

for details, see accessories section

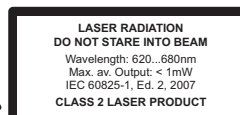
laser warning

Complies with 21 CFR 1040.10 and 1040.11 except for deviations pursuant to laser notice No. 50, dated June 24, 2007

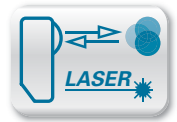

relative receiving signal

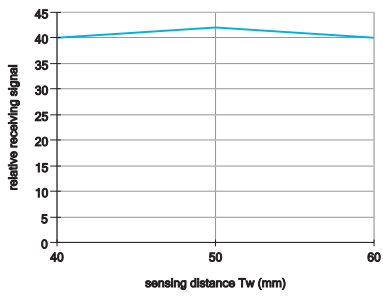

beam characteristic (typically)

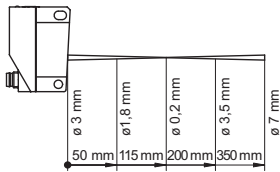

dimension drawing

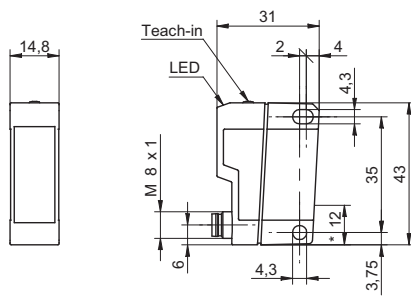

* emitter axis

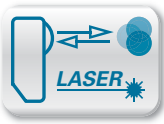

Tw = 0 ... 250 mm

- with analog output
- high repeatability
- very short response time

general data

| | |
|---|-------------------------|
| type | diffuse contrast sensor |
| light source | pulsed red laser diode |
| sensing distance Tw | 0 ... 250 mm |
| optimum operating distance | 40 ... 80 mm |
| detectable remission difference (on grey) | > 8 % |
| repeat accuracy | < 0,1 mm at laser focus |
| output indicator | LED yellow |
| sensitivity adjustment | potentiometer, 14 turn |
| laser class | 1 |
| distance to focus | 80 mm |
| wave length | 650 nm |

electrical data

| | |
|------------------------------------|--------------------------|
| response time / release time | < 0,1 ms |
| voltage supply range +Vs | 12 ... 30 VDC |
| current consumption max. (no load) | 65 mA |
| current consumption typ. | 60 mA |
| voltage drop Vd | < 2 VDC |
| output function | light operate |
| output circuit | PNP / analog 4 ... 20 mA |
| output current | < 200 mA |
| short circuit protection | yes |
| reverse polarity protection | yes |

mechanical data

| | |
|------------------|---------------|
| width / diameter | 15,4 mm |
| height / length | 50 mm |
| depth | 50 mm |
| type | rectangular |
| housing material | die-cast zinc |
| front (optics) | glass |

ambient conditions

| | |
|-----------------------|----------------|
| operating temperature | -10 ... +50 °C |
| protection class | IP 67 |

order reference

OZDM 16P1901
OZDM 16P1901/S14

connection types

cable 4 pin, 2 m
connector M12 4 pin

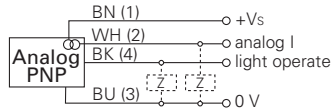
**connection diagram****connectors**

| | | |
|--------------|-------|--------------|
| ESG 34AH0200 | 4 pin | 2 m straight |
| ESW 33AH0200 | 4 pin | 2 m angular |

additional cable connectors and field wireable connectors, see accessories

accessories

| | |
|-----------------------|----------|
| SENSOFIX mounting kit | 10151721 |
| mounting bracket | 10113917 |

for details, see accessories section

laser warning

**CLASS 1 LASER
PRODUCT**

Complies with 21 CFR 1040.10 and 1040.11
except for deviations pursuant to laser
notice No. 50, dated June 24, 2007

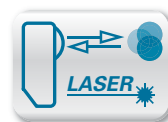

signal progression

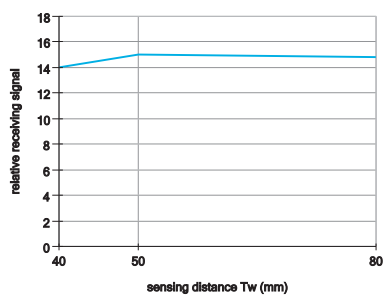

beam characteristic (typically)

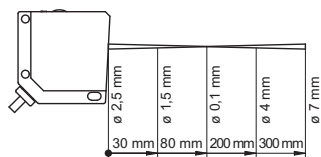

dimension drawings

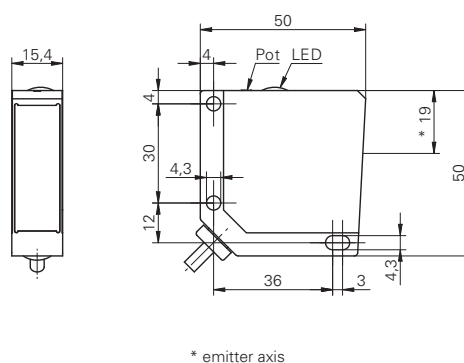
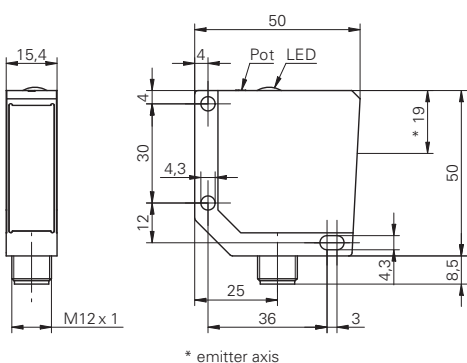

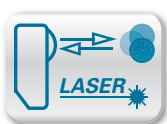

Tw = 0 ... 250 mm

- rugged metal housing
- high repeatability
- very short response time

general data

| | |
|---|-------------------------|
| type | diffuse contrast sensor |
| light source | pulsed red laser diode |
| sensing distance Tw | 0 ... 250 mm |
| optimum operating distance | 40 ... 80 mm |
| detectable remission difference (on grey) | > 8 % |
| repeat accuracy | < 0,1 mm at laser focus |
| output indicator | LED yellow |
| sensitivity adjustment | potentiometer, 14 turn |
| laser class | 1 |
| distance to focus | 80 mm |
| wave length | 650 nm |

electrical data

| | |
|------------------------------------|---------------|
| response time / release time | < 0,05 ms |
| voltage supply range +Vs | 12 ... 30 VDC |
| current consumption max. (no load) | 65 mA |
| current consumption typ. | 60 mA |
| voltage drop Vd | < 2 VDC |
| output current | < 200 mA |
| short circuit protection | yes |
| reverse polarity protection | yes |

mechanical data

| | |
|------------------|---------------|
| width / diameter | 15,4 mm |
| height / length | 50 mm |
| depth | 50 mm |
| type | rectangular |
| housing material | die-cast zinc |
| front (optics) | glass |

ambient conditions

| | |
|-----------------------|----------------|
| operating temperature | -10 ... +50 °C |
| protection class | IP 67 |



connection diagrams

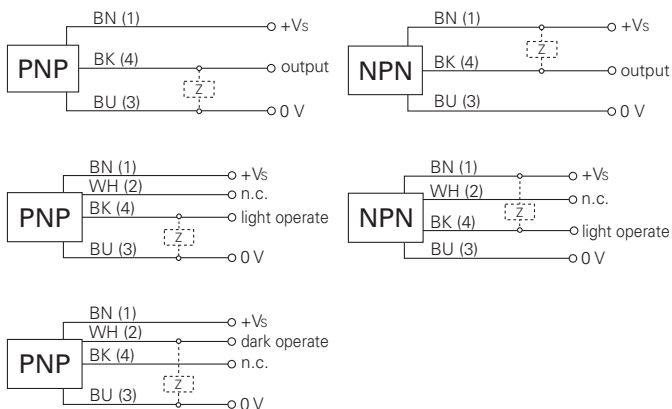

connectors

| | | |
|--------------|-------|--------------|
| ESG 34AH0200 | 4 pin | 2 m straight |
| ESW 33AH0200 | 4 pin | 2 m angular |

additional cable connectors and field wireable connectors, see accessories

accessories

| | |
|-----------------------|----------|
| SENSOFIX mounting kit | 10151721 |
| mounting bracket | 10113917 |

for details, see accessories section

laser warning



Complies with 21 CFR 1040.10 and 1040.11 except for deviations pursuant to laser notice No. 50, dated June 24, 2007

| order reference | connection types | output circuit | output function |
|------------------|---------------------|----------------|-----------------|
| OZDM 16N1001 | cable 3 pin, 2 m | NPN | light operate |
| OZDM 16N1001/S14 | connector M12 4 pin | NPN | light operate |
| OZDM 16P1001 | cable 3 pin, 2 m | PNP | light operate |
| OZDM 16P1001/S14 | connector M12 4 pin | PNP | light operate |
| OZDM 16P3001 | cable 3 pin, 2 m | PNP | dark operate |
| OZDM 16P3001/S14 | connector M12 4 pin | PNP | dark operate |

OZDM 16 Tw = 0 ... 250 mm

Diffuse contrast sensors

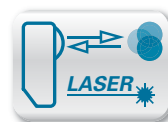

relative receiving signal

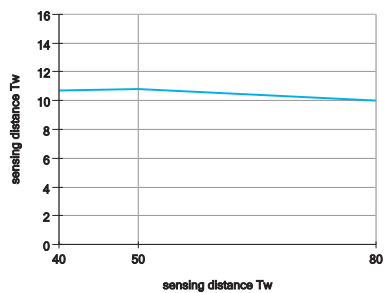

beam characteristic (typically)

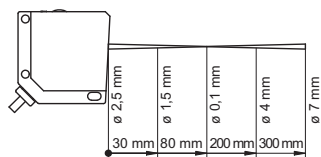

dimension drawings

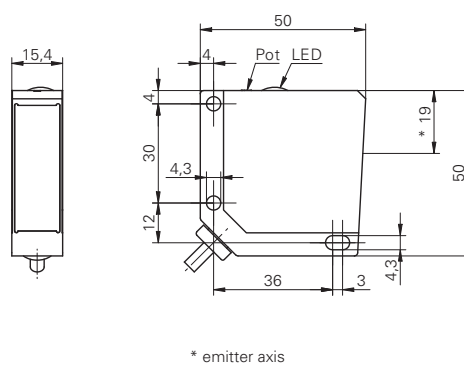
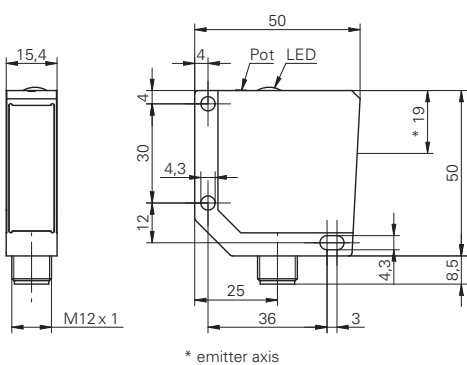



Accessories

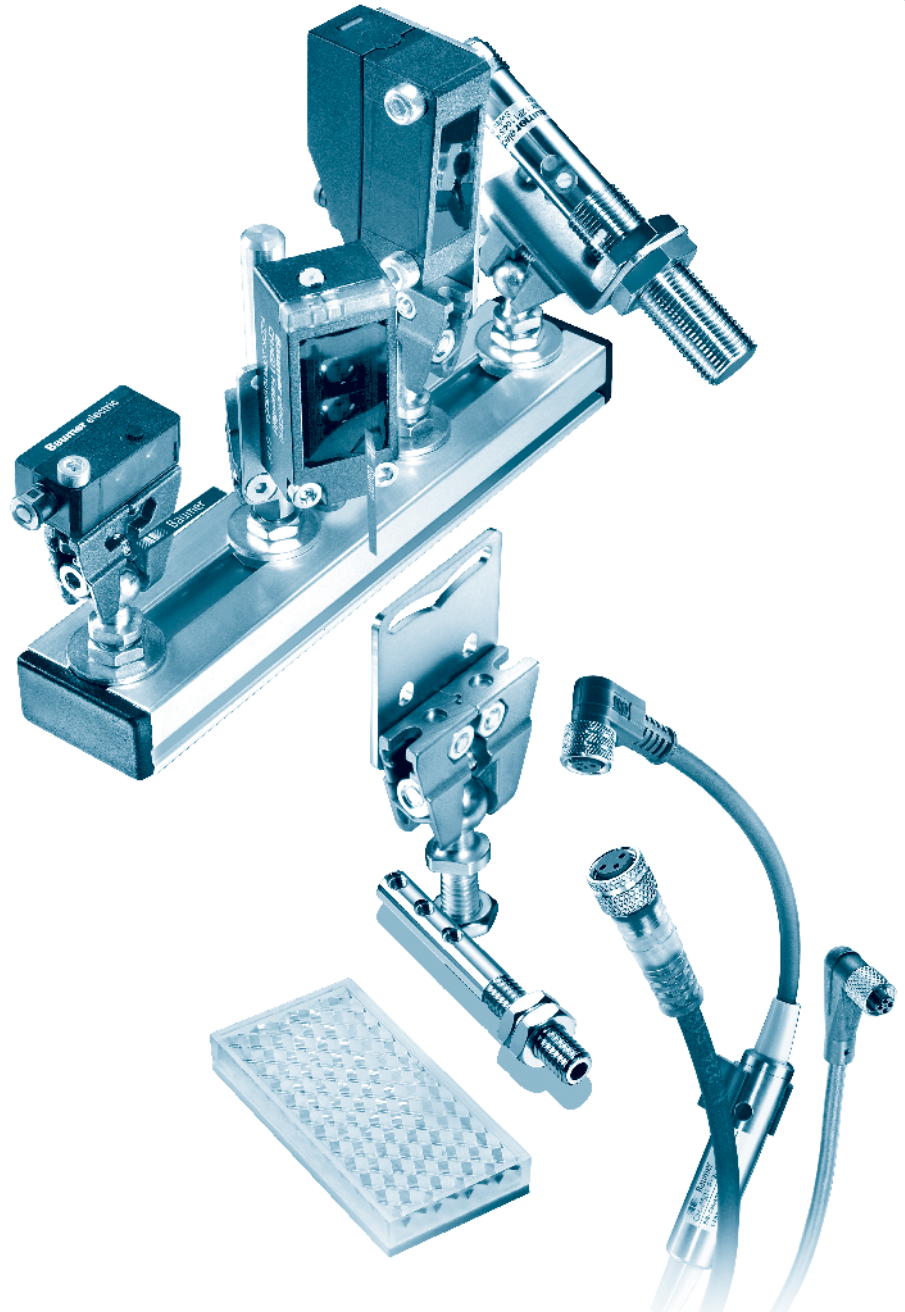

| | |
|----------------------------------|----------|
| Connectors and mating connectors | Page 420 |
| Connectors/Pin assignment | Page 425 |
| Reflectors | Page 426 |
| Divers | Page 431 |
| Mounting | Page 433 |
| Mounting kits Sensofix | Page 437 |
| Hygienic and washdown | Page 439 |
| Fiber optics | Page 441 |

ES 14 - Cable socket M12 angular, not pre-assembled

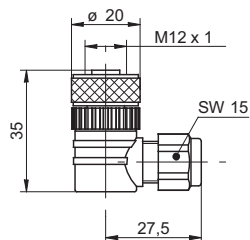

| order reference | |
|-----------------|-------------------------------|
| ES 14 PG7 | Connector M12, 4 pin, angular |
| ES 14C PG7 | Connector M12, 5 pin, angular |

- Connector unshielded
- Connector only, no cable supplied
- 4 and 5 pin versions

ES 18 - Cable socket M12 straight, not pre-assembled

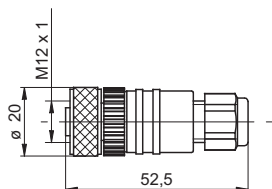

| order reference | |
|-----------------|--------------------------------|
| ES 18 PG7 | Connector M12, 4 pin, straight |
| ES 18C PG7 | Connector M12, 5 pin, straight |

- Connector unshielded
- Connector only, no cable supplied
- 4 and 5 pin versions

ES 21 - Cable socket M8 straight, not pre-assembled

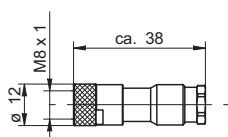

| order reference | |
|-----------------|-------------------------------|
| ES 21 | Connector M8, 3 pin, straight |
| ES 21A | Connector M8, 4 pin, straight |

- Connector unshielded
- Connector only, no cable supplied
- 3 and 4 pin version

ES 22 - Cable socket M8 angular, not pre-assembled

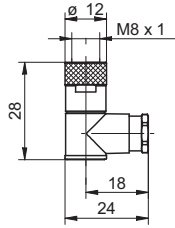

| order reference | |
|-----------------|------------------------------|
| ES 22 | Connector M8, 3 pin, angular |
| ES 22A | Connector M8, 4 pin, angular |

- Connector unshielded
- Connector only, no cable supplied
- 3 and 4 pin versions

ESG 32 - Connector M8 straight

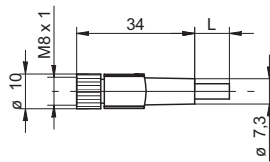

| order reference | |
|-----------------|-------------------------------------|
| ESG 32AH0200 | Connector M8, 4 pin, straight, 2 m |
| ESG 32AH0500 | Connector M8, 4 pin, straight, 5 m |
| ESG 32AH1000 | Connector M8, 4 pin, straight, 10 m |
| ESG 32SH0200 | Connector M8, 3 pin, straight, 2 m |
| ESG 32SH0500 | Connector M8, 3 pin, straight, 5 m |
| ESG 32SH1000 | Connector M8, 3 pin, straight, 10 m |

- Connector unshielded
- 3 and 4 pin versions
- Cable coating PUR
- Halogen-free
- Suitable for flexible cable carriers
- UL listed, number E315836

ESG 32G - Connector M8 straight, shielded

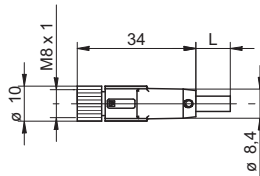

| order reference | |
|-----------------|---|
| ESG 32AH0200G | Connector M8, 4 pin, straight, 2 m, shielded |
| ESG 32AH0500G | Connector M8, 4 pin, straight, 5 m, shielded |
| ESG 32AH1000G | Connector M8, 4 pin, straight, 10 m, shielded |
| ESG 32SH0500G | Connector M8, 3 pin, straight, 5 m, shielded |
| ESG 32SH1000G | Connector M8, 3 pin, straight, 10 m, shielded |

- Connector shielded, screen connected with cap nut
- 3 and 4 pin versions
- Cable coating PUR
- Halogen-free
- Suitable for flexible cable carriers
- UL listed, number E315836

ESW 31 - Connector M8 angular

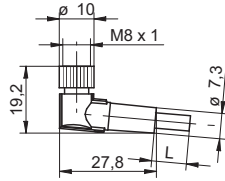

| order reference | |
|-----------------|------------------------------------|
| ESW 31AH0200 | Connector M8, 4 pin, angular, 2 m |
| ESW 31AH0500 | Connector M8, 4 pin, angular, 5 m |
| ESW 31AH1000 | Connector M8, 4 pin, angular, 10 m |
| ESW 31SH0200 | Connector M8, 3 pin, angular, 2 m |
| ESW 31SH0500 | Connector M8, 3 pin, angular, 5 m |
| ESW 31SH1000 | Connector M8, 3 pin, angular, 10 m |

- Connector unshielded
- 3 and 4 pin versions
- Cable coating PUR
- Halogen-free
- Suitable for flexible cable carriers
- UL listed, number E315836

ESW 31G - Connector M8 angular, shielded

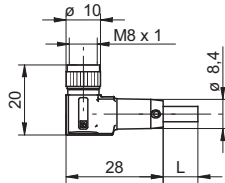

| order reference | |
|-----------------|--|
| ESW 31AH0200G | Connector M8, 4 pin, angular, 2 m, shielded |
| ESW 31AH0500G | Connector M8, 4 pin, angular, 5 m, shielded |
| ESW 31AH1000G | Connector M8, 4 pin, angular, 10 m, shielded |
| ESW 31SH0200G | Connector M8, 3 pin, angular, 2 m, shielded |
| ESW 31SH0500G | Connector M8, 3 pin, angular, 5 m, shielded |

- Connector shielded, screen connected with cap nut
- 3 and 4 pin versions
- Cable coating PUR
- Halogen-free
- Suitable for flexible cable carriers
- UL listed, number E315836

ESG 34 - Connector M12 straight

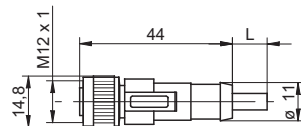

| order reference | |
|-----------------|--------------------------------------|
| ESG 34AH0200 | Connector M12, 4 pin, straight, 2 m |
| ESG 34AH0500 | Connector M12, 4 pin, straight, 5 m |
| ESG 34AH1000 | Connector M12, 4 pin, straight, 10 m |
| ESG 34CH0200 | Connector M12, 5 pin, straight, 2 m |
| ESG 34CH0500 | Connector M12, 5 pin, straight, 5 m |
| ESG 34SH0200 | Connector M12, 3 pin, straight, 2 m |
| ESG 34SH0500 | Connector M12, 3 pin, straight, 5 m |
| ESG 34SH1000 | Connector M12, 3 pin, straight, 10 m |

- Connector unshielded
- 3, 4 and 5 pin versions
- Cable coating PUR
- Halogen-free
- Suitable for flexible cable carriers
- UL listed, number E315836

ESG 34G - Connector M12 straight, shielded

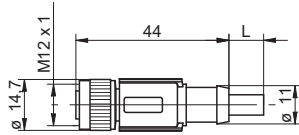

- Connector shielded, screen connected with cap nut
- 4, 5 and 8 pin versions
- Cable coating PUR
- Halogen-free
- Suitable for flexible cable carriers
- UL listed, number E315836

order reference

| | |
|---------------|--|
| ESG 34AH0200G | Connector M12, 4 pin, straight, 2 m, shielded |
| ESG 34AH0500G | Connector M12, 4 pin, straight, 5 m, shielded |
| ESG 34AH1000G | Connector M12, 4 pin, straight, 10 m, shielded |
| ESG 34CH0200G | Connector M12, 5 pin, straight, 2 m, shielded |
| ESG 34CH0500G | Connector M12, 5 pin, straight, 5 m, shielded |
| ESG 34CH1000G | Connector M12, 5 pin, straight, 10 m, shielded |
| ESG 34FH0200G | Connector M12, 8 pin, straight, 2 m, shielded |
| ESG 34FH0500G | Connector M12, 8 pin, straight, 5 m, shielded |
| ESG 34FH1000G | Connector M12, 8 pin, straight, 10 m, shielded |

ESG 34F - Connector M12 straight, PVC/V4A

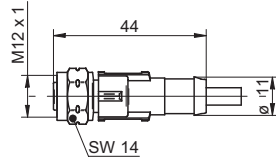

- Connector unshielded
- 4 pin version
- Cable coating PVC
- Cap nut material in stainless steel V4A
- Ecolab certified and FDA conform
- UL listed, number E315836

order reference

| | |
|--------------|---|
| ESG 34AF0200 | Connector M12, 4 pin, straight, 2 m, V4A-PVC |
| ESG 34AF0500 | Connector M12, 4 pin, straight, 5 m, V4A-PVC |
| ESG 34AF1000 | Connector M12, 4 pin, straight, 10 m, V4A-PVC |
| ESG 34AF2500 | Connector M12, 4 pin, straight, 25 m, V4A-PVC |

ESW 33 - Connector M12 angular

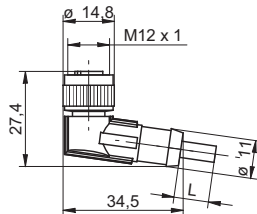

- Connector unshielded
- 3, 4 and 5 pin versions
- Cable coating PUR
- Halogen-free
- Suitable for flexible cable carriers
- UL listed, number E315836

order reference

| | |
|--------------|-------------------------------------|
| ESW 33AH0200 | Connector M12, 4 pin, angular, 2 m |
| ESW 33AH0500 | Connector M12, 4 pin, angular, 5 m |
| ESW 33AH1000 | Connector M12, 4 pin, angular, 10 m |
| ESW 33CH0200 | Connector M12, 5 pin, angular, 2 m |
| ESW 33CH0500 | Connector M12, 5 pin, angular, 5 m |
| ESW 33SH0200 | Connector M12, 3 pin, angular, 2 m |
| ESW 33SH0500 | Connector M12, 3 pin, angular, 5 m |
| ESW 33SH1000 | Connector M12, 3 pin, angular, 10 m |

ESW 33G - Connector M12 angular, shielded

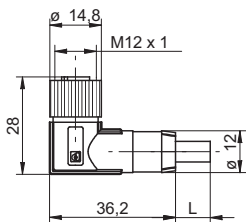

| order reference | |
|-----------------|---|
| ESW 33AH0200G | Connector M12, 4 pin, angular, 2 m, shielded |
| ESW 33AH0500G | Connector M12, 4 pin, angular, 5 m, shielded |
| ESW 33AH1000G | Connector M12, 4 pin, angular, 10 m, shielded |
| ESW 33CH0500G | Connector M12, 5 pin, angular, 5 m, shielded |
| ESW 33FH0200G | Connector M12, 8 pin, angular, 2 m, shielded |
| ESW 33FH0500G | Connector M12, 8 pin, angular, 5 m, shielded |
| ESW 33FH1000G | Connector M12, 8 pin, angular, 10 m, shielded |

- Connector shielded, screen connected with cap nut
- 4, 5 and 8 pin versions
- Cable coating PUR
- Halogen-free
- Suitable for flexible cable carriers
- UL listed, number E315836

ESW 33F - Connector M12 angular, PVC/V4A

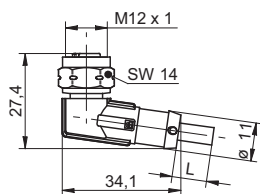

| order reference | |
|-----------------|--|
| ESW 33AF0200 | Connector M12, 4 pin, angular, 2 m, V4A-PVC |
| ESW 33AF0500 | Connector M12, 4 pin, angular, 5 m, V4A-PVC |
| ESW 33AF2500 | Connector M12, 4 pin, angular, 25 m, V4A-PVC |

- Connector unshielded
- 4 pin version
- Cable coating PVC
- Cap nut material in stainless steel V4A
- Ecolab certified and FDA conform
- UL listed, number E315836

3 pin

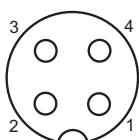

- 1 = BN
- 2 = n.c.
- 3 = BU
- 4 = WH

ESG 34
ESW 33

3 pin

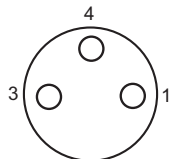

- 1 = BN
- 3 = BU
- 4 = BK

ES 21
ES 22
ESG 32
ESG 32G
ESW 31
ESW 31G

4 pin

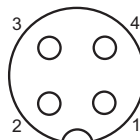

- 1 = BN (+Vs)
- 2 = WH (output)
- 3 = BU (0V)
- 4 = BK (output)

ES 14
ES 18
ESG 34
ESG 34F
ESG 34G
ESW 33
ESW 33F
ESW 33G

4 pin

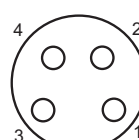

- 1 = BN
- 2 = WH
- 3 = BU
- 4 = BK

ES 21A
ES 22A
ESG 32
ESG 32G
ESW 31
ESW 31G

5 pin

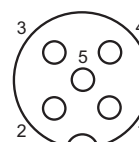

- 1 = BN
- 2 = WH
- 3 = BU
- 4 = BK
- 5 = GY

ES 14C
ES 18C
ESG 34
ESG 34G
ESW 33
ESW 33G

8 pin

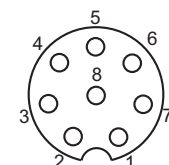

- 1 = WH
- 2 = BN
- 3 = GN
- 4 = YE
- 5 = GY
- 6 = PK
- 7 = BU
- 8 = RD

ESG 34G
ESW 33G

FTAR 013

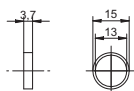

- Fastening method self-adhesive
- Micro structure
- For Retro-reflective sensors

order reference

FTAR 013A000 Reflector round Ø 15 mm

FTAR 014

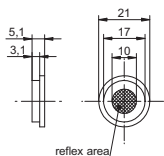

- Fastening method self-adhesive
- For Retro-reflective sensors

order reference

FTAR 014A000 Reflector round Ø 21 mm

FTAR 020

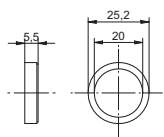
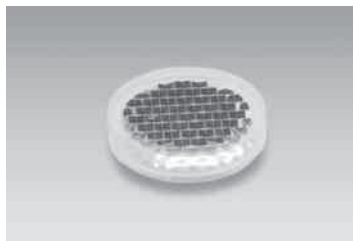

- Fastening method self-adhesive
- Micro structure
- For Retro-reflective sensors

order reference

FTAR 020A000 Reflector round Ø 25,2 mm

FTAR 038

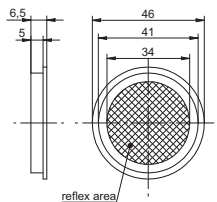

- Fastening method self-adhesive
- For Retro-reflective sensors

order reference

FTAR 038A000 Reflector round Ø 46 mm

FTDR 010A

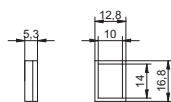

- Fastening method self-adhesive
- For Retro-reflective sensors

order reference

FTDR010A014 Reflector rectangular 16,8 x 12,8 mm

FTDR 010D

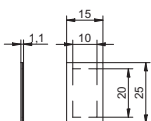

- Fastening method self-adhesive
- For laser light sensors

order reference

FTDR 010D020 Reflector rectangular 15 x 25 mm

FTDR 015

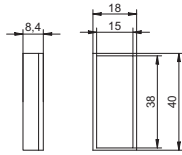
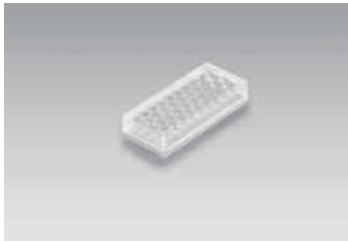

- Fastening method self-adhesive
- For Retro-reflective sensors

order reference
 FTDR015A038 Reflector rectangular 40 x 18 mm

FTDR 017

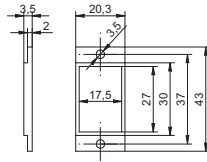
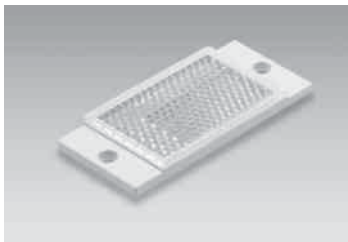

- Fastening method screw mounting
- Micro structure
- For Retro-reflective sensors

order reference
 FTDR017A027 Reflector rectangular 43 x 20,3 mm

FTDR 029

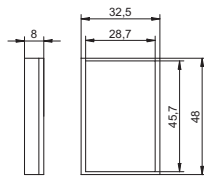

- Fastening method self-adhesive
- For Retro-reflective sensors

order reference
 FTDR 029A046 Reflector rectangular 48 x 32,5 mm

FTDR 047

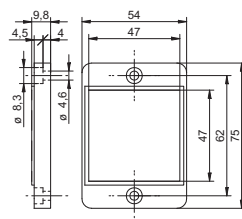

- Fastening method screw mounting
- For Retro-reflective sensors

order reference
 FTDR 047A048 Reflector rectangular 75 x 54 mm

FTDR 051

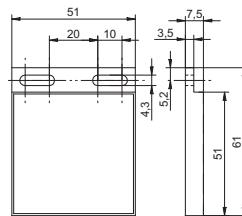
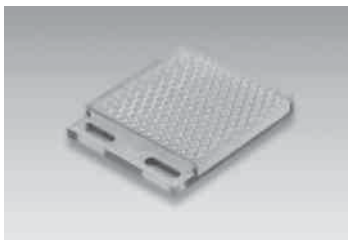

- Detergent resistant reflecteur
- Ecolab approved
- For Retro-reflective sensors

order reference
 FTDR 051E051 Ecolab approved reflecteur

FTDR 050

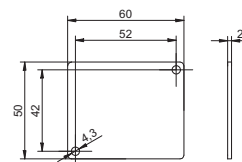

- Stainless steel reflector for SmartReflect in washdown design
- Material: Stainless steel V4A

order reference
 FTDR 050R060 Stainless steel reflector for SmartReflect in washdown design

FTDR 084

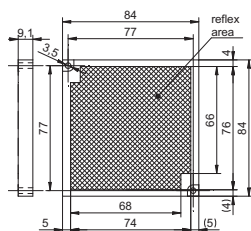
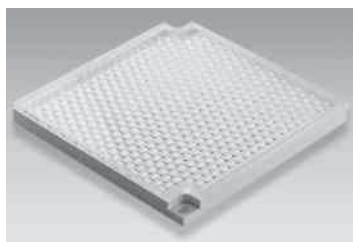

- Fastening method screw mounting
- For Retro-reflective sensors

order reference
 FTDR 084A084 Reflector rectangular 84 x 84 mm

FTDR 017W

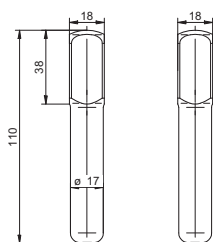

- Stainless steel reflector for SmartReflect in hygiene design
- EHEDG-certified

Accessorie: "mounting for sensors in hygienic design Ø17", order reference HI17-1H

order reference
 FTDR 017W035 Stainless steel reflector for SmartReflect in hygiene design

FTDF 020F



- Fastening method self-adhesive
- For laser light sensors

order reference
 FTDF 020F020 Reflective type rectangular 20 x 20 mm

FTDL 050

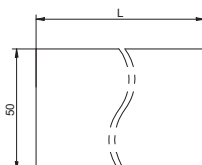
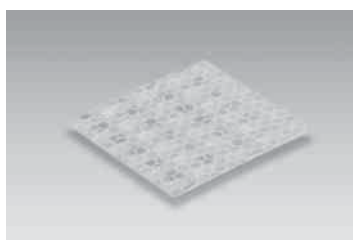

- Fastening method self-adhesive
- For Retro-reflective sensors

order reference
 FTDL 050K000/... m Reflective type by the meter 50 x ... mm

FTDR 005

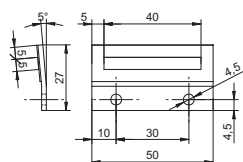

- Fastening method screw mounting
- For pocket-size line sensor *PosCon*

order reference
 FTDR 005I040 Reflector rectangular 50 x 27 mm

FTDR 020

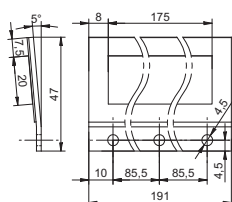
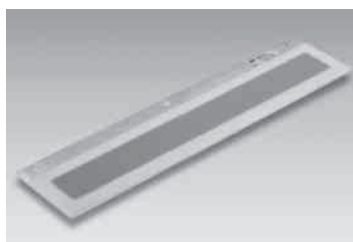

- Fastening method screw mounting
- For pocket-size line sensor *PosCon*

order reference
 FTDR 020I175 Reflector rectangular 191 x 47 mm

FTDR 035

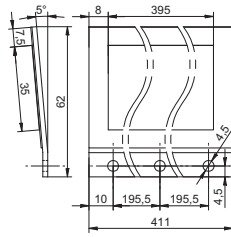

- Fastening method screw mounting
- For pocket-size line sensor *PosCon*

order reference

FTDR 035I395 Reflector rectangular 411 x 62 mm

FTDF 005

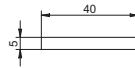

- Fastening method self-adhesive
- For pocket-size line sensor *PosCon*

order reference

FTDF 005I040 Reflective type rectangular 40 x 5 mm

FTDF 020

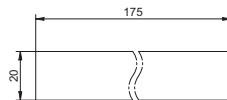

- Fastening method self-adhesive
- For pocket-size line sensor *PosCon*

order reference

FTDF 020I175 Reflective type rectangular 175 x 20 mm

FTDF 035I

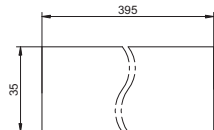

- Fastening method self-adhesive
- For pocket-size line sensor *PosCon*

order reference

FTDF 035I395 Reflective type rectangular 335 x 35 mm

FTDL

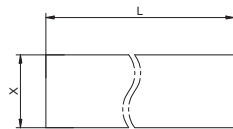
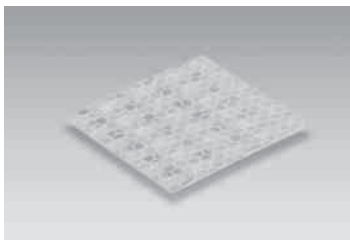

- Fastening method self-adhesive, for pocke-size line sensor *PosCon*

order reference

| | |
|--------------------|---|
| FTDL 005I000/... m | Reflective type by the meter 5 mm (x) wide |
| FTDL 020I000/... m | Reflective type by the meter 20 mm (x) wide |
| FTDL 035I000/... m | Reflective type by the meter 35 mm (x) wide |
| FTDL 050I000/... m | Reflective type by the meter 50 mm (x) wide |
| FTDL 610I000/... m | Reflective type by the meter 50 mm (x) wide |

FTDF 012

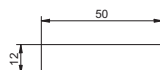

- Fastening method self-adhesive
- For pocket-size line sensor *ParCon*

order reference

FTDF 012M050 Reflective type rectangular 50 x 12 mm

FTDF 035

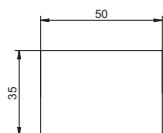
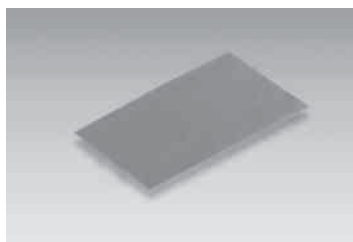

- Fastening method self-adhesive
- For pocket-size line sensor *ParCon*

order reference

FTDF 035M050 Reflective type rectangular 50 x 34 mm

FTDF 050

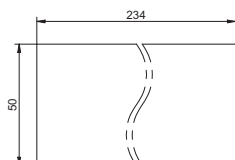

- Fastening method self-adhesive
- For pocket-size line sensor *ParCon*

order reference

FTDF 050M234 Reflective type rectangular 50 x 234 mm

FTDR 008/01

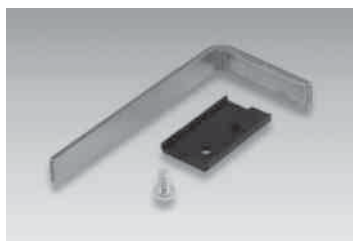

- Bracket with reflector film
- For pocket-size line sensor *ParCon*

order reference

FTDR 008M030/01 Reflector bracket high

FTDR 008/21

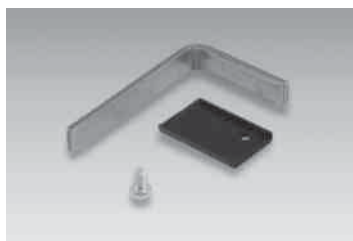

- Bracket with reflector film
- For pocket-size line sensor *ParCon*

order reference

FTDR 008M030/21 Reflector bracket lateral

Slot aperture stickers series 14

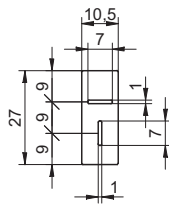

- Material: Polyester foil
- Contents: 2 pieces
- self-adhesive

For use with FSDK 14 / FEDK 14

order reference

10144075 Slot aperture stickers series 14

Protector cap for OxDM 20

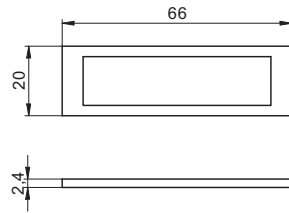

- Material: PMMA
- Self-adhesive

order reference

10156878 Protector cap OxDM 20

Glass cover for sensors series 18

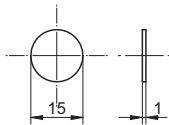

- Material: glass

For use with cap nut series 18

order reference

10103068 Glass cover series 18

Glass cover for sensors series 30

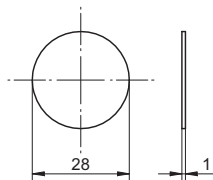

- Material: glass

For use with cap nut series 30

order reference

10103226 Glass cover series 30

Doubling lens for sensors serie 18

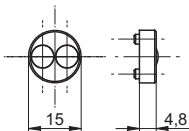

- Material: PBTP / glass
- For double the sensing distance FZAM 18

For use with FZAM 18

order reference

10107250 Doubling lens series 18 FZAM 18

Doubling lens for sensors serie 30

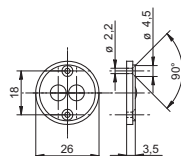

- Material: PC / glass
- For double the sensing distance FZAM 30

For use with FZAM 30

order reference

10107408 Doubling lens series 30 FZAM 30

Cap nut for photoelectric sensors series 18

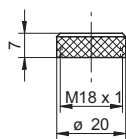

- Material: Nickel-plated brass

For use with FZAM 18 (with glass cover)

order reference

10103067 Cap nut glass cover for sensors series 18

Cap nut for photoelectric sensors series 18

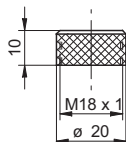

- Material: Nickel-plated brass

For use with FZAM 18 (with doubling lens)

order reference

10115913 Cap nut glass cover and doubling lens for sensors series 18

Cap nut for photoelectric sensors series 30

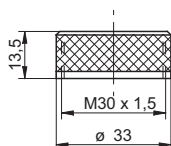

- Material: Nickel-plated brass

For use with FZAM 30 (with glass cover)

order reference

10102801 Cap nut glass cover for sensors series 30

Mounting bracket for sensors series 10 (U design)

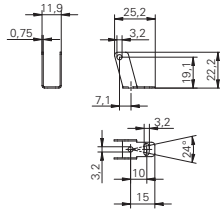

- Material: Steel
- For use with UxDK 10, FxDK 10, OxDK 10 (only cabel versions)

order reference
10114501 Mounting bracket series 10 (U design)

Mounting bracket for sensors series 12

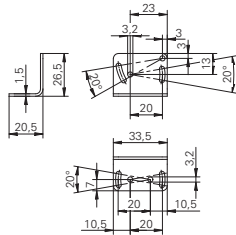

- Material: Steel
- For use with FxDM 12, OxDM 12

order reference
10113873 Mounting bracket series 12 (L design)

Mounting bracket for sensors series 13

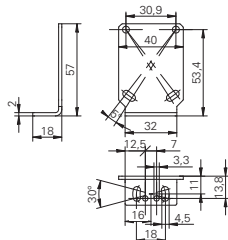

- Material: Steel
- For use with OxDM 13

order reference
10161695 Mounting bracket for sensors series 13 (L design)

Mounting bracket for sensors series 14

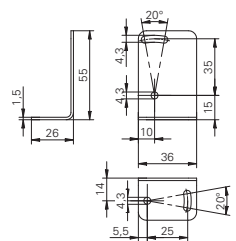

- Material: Steel
- For use with FxDK 14, OxDK 14

order reference
10134964 Mounting bracket series 14 (L design)

Mounting bracket for washdown sensors series 14

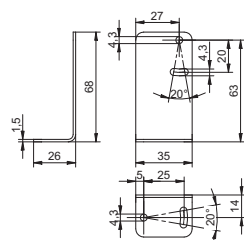

- Material: Stainless Steel
- For use with FxDR 14

order reference
11046278 Mounting bracket series 14 washdown

Mounting bracket for sensors series 15

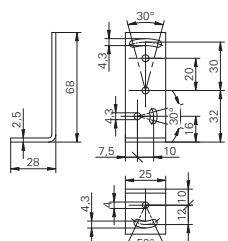

- Material: Steel
- For use with FxDM 15

order reference
10103415 Mounting bracket series 15 (L design)

Mounting bracket for sensors series 16

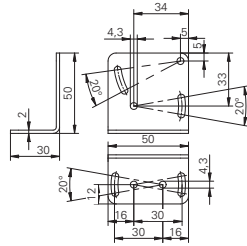

- Material: Steel
- For use with FxDM 16, OxDM 16

order reference
10113917 Mounting bracket series 16 (L design)

Feinjustagebefestigung Serie 16

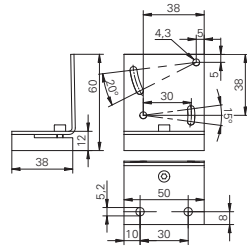

- Material: Steel
- Simplifies the alignment of the laser sensors series OSDM 16 / OEDM 16

order reference
10119373 Mounting bracket for fine adjustment series 16

Lens cleaning air nozzle bracket

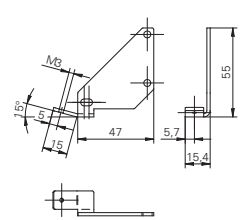

- Material: Steel
- For use with FxDM 16, OxDM 16

order reference
10116407 Lens cleaning air nozzle bracket

Mounting bracket for sensor OxDM 20

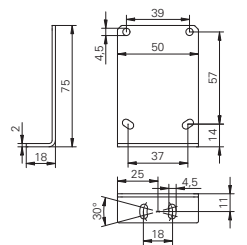

- Material: Steel
- For use with OADM 20, OADM 250

order reference
11010227 Mounting bracket OxDM 20

Mounting bracket for Logipal/PosCon

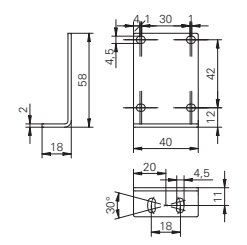

- Material: Steel
- For use with ZADM 023, FKDM 22

order reference
10126220 Mounting bracket series 22 L design

Mounting bracket for sensors series 26

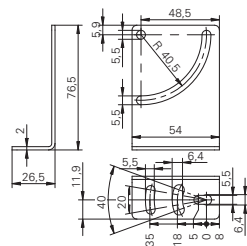
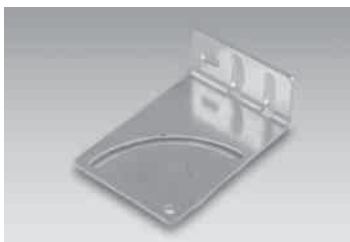

- Material: Steel
- For use with FxDK 26

order reference
10112477 Mounting bracket series 26 (L design)

Mounting bracket for Verisens

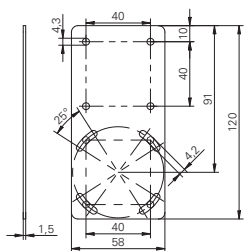

- Material: Steel

order reference
10159905 Mounting bracket for Verisens

Mounting bracket for Verisens (L)

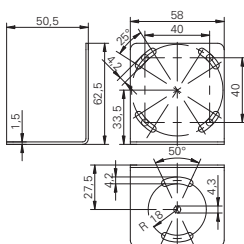
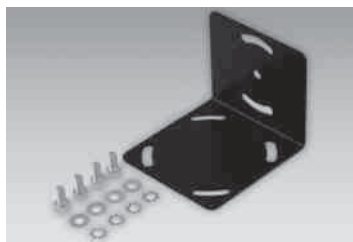

- Material: Steel

order reference
10159906 Mounting bracket for Verisens L design

Sensofix-Base module

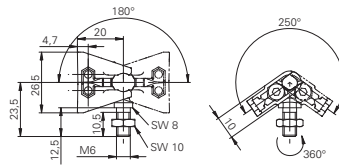

- Clamps made of stainless steel
- Ball pivots made of galvanized steel

order reference

10149010 Sensofix-Base module

Sensofix-Mounting kit for sensors series 08 round

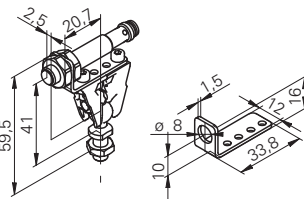
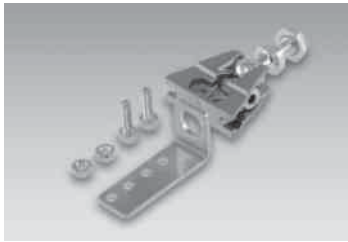

- Clamps made of stainless steel
- Ball pivots made of galvanized steel
- Mounting panel made of stainless steel

For use with all sensors in M8 housing

order reference

10151719 Sensofix series 08

Sensofix-Mounting kit for sensors series 12

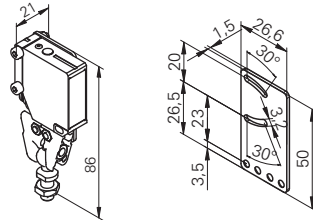

- Clamps made of stainless steel
- Ball pivots made of galvanized steel
- Mounting panel made of stainless steel

For use with FxDM 12, OxDM 12

order reference

10150328 Sensofix series 12

Sensofix-Mounting kit for sensors series 12 round

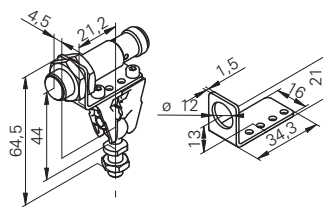

- Clamps made of stainless steel
- Ball pivots made of galvanized steel
- Mounting panel made of stainless steel

For use with all sensors in M12 housing

order reference

10151720 Sensofix series 12 round

Sensofix-Mounting kit for sensors series 13

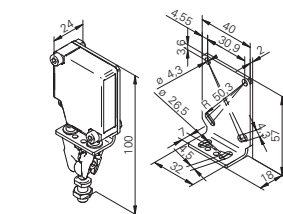

- Clamps made of stainless steel
- Ball pivots made of galvanized steel
- Mounting panel made of stainless steel

For use with OADM 13

order reference

10161829 Sensofix series 13

Sensofix-Mounting kit for sensors series 14

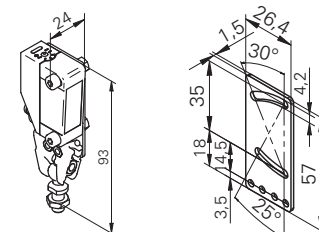

- Clamps made of stainless steel
- Ball pivots made of galvanized steel
- Mounting panel made of stainless steel

For use with FxDK 14, OxDK 14

order reference

10149011 Sensofix series 14

Sensofix-Mounting kit for washdown sensors series 14

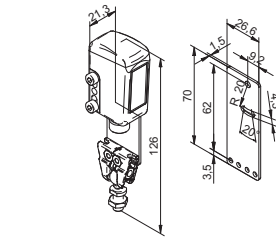

- Clamps made of stainless steel
- Ball pivots made of galvanized steel
- Mounting panel made of stainless steel

For use with FxDR 14

order reference

11046279 Sensofix series 14 washdown

Sensofix-Mounting kit for sensors series 16

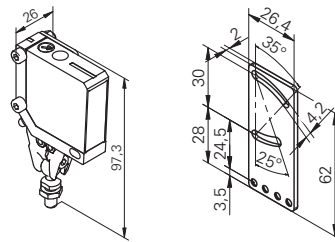

- Mounting panel made of stainless steel
- Clamps made of stainless steel
- Ball pivots made of galvanized steel

For use with FxDM 16, OxDM 16

order reference

10151721 Sensofix series 16

Sensofix-Mounting kit for sensors series 18 round

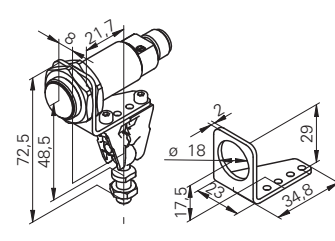

- Clamps made of stainless steel
- Ball pivots made of galvanized steel
- Mounting panel made of stainless steel

For use with all sensors in M18 housing

order reference

10151658 Sensofix series 18

Sensofix-Mounting kit for sensors series 10/20

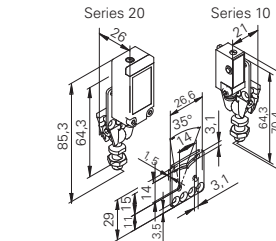

- Clamps made of stainless steel
- Ball pivots made of galvanized steel
- Mounting panel made of stainless steel

For use with photoelectric and ultrasonic sensors series 10, series 20

order reference

10150326 Sensofix series 10 / series 20

ESG 34F - Connector M12 straight, PVC/V4A

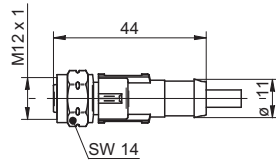

| order reference | |
|-----------------|---|
| ESG 34AF0200 | Connector M12, 4 pin, straight, 2 m, V4A-PVC |
| ESG 34AF0500 | Connector M12, 4 pin, straight, 5 m, V4A-PVC |
| ESG 34AF1000 | Connector M12, 4 pin, straight, 10 m, V4A-PVC |
| ESG 34AF2500 | Connector M12, 4 pin, straight, 25 m, V4A-PVC |

- Connector unshielded
- 4 pin version
- Cable coating PVC
- Cap nut material in stainless steel V4A
- Ecolab certified and FDA conform
- UL listed, number E315836

ESW 33F - Connector M12 angular, PVC/V4A

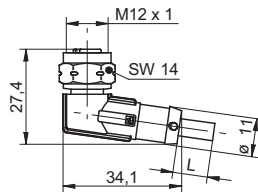

| order reference | |
|-----------------|--|
| ESW 33AF0200 | Connector M12, 4 pin, angular, 2 m, V4A-PVC |
| ESW 33AF0500 | Connector M12, 4 pin, angular, 5 m, V4A-PVC |
| ESW 33AF2500 | Connector M12, 4 pin, angular, 25 m, V4A-PVC |

- Connector unshielded
- 4 pin version
- Cable coating PVC
- Cap nut material in stainless steel V4A
- Ecolab certified and FDA conform
- UL listed, number E315836

Mounting HI17-1H for sensors in hygienic design Ø 17 mm

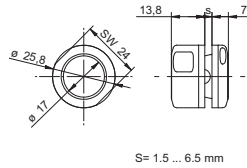

- Material: Stainless steel V4A
- EHEDG-certified

For use with inductive sensors 17 mm and photoelectric sensors in hygienic design

order reference
HI17-1H Mounting for sensors in hygienic design Ø 17 mm

Mounting bracket for washdown sensors series 14

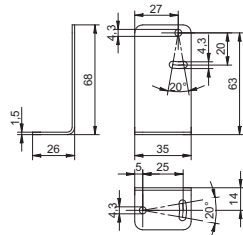

- Material: Stainless Steel
- For use with FxDR 14

order reference
11046278 Mounting bracket series 14 washdown

Sensofix-Mounting kit for washdown sensors series 14

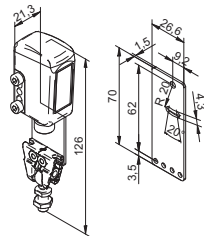

- Clamps made of stainless steel
 - Ball pivots made of galvanized steel
 - Mounting panel made of stainless steel
- For use with FxDR 14

order reference
11046279 Sensofix series 14 washdown

FTDR 051

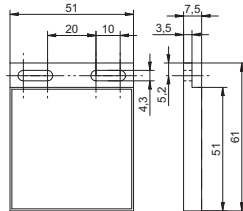
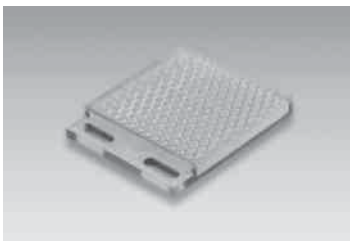

- Detergent resistant reflecteur
- Ecolab approved
- For Retro-reflective sensors

order reference
FTDR 051E051 Ecolab approved reflecteur

FTDR 050

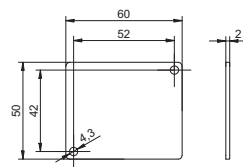

- Stainless steel reflector for SmartReflect in washdown design
- Material: Stainless steel V4A

order reference
FTDR 050R060 Stainless steel reflector for SmartReflect in washdown design

FTDR 017W

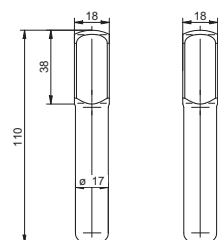

- Stainless steel reflector for SmartReflect in hygiene design
- EHEDG-certified

Accessorie: "mounting for sensors in hygienic design Ø17", order reference HI17-1H

order reference
FTDR 017W035 Stainless steel reflector for SmartReflect in hygiene design

Hygienic and washdown

Accessories

Doubling lens M2,6

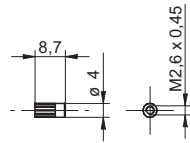

- Increases the actual range S_b by a factor of 6
- Contents: 2 pieces

For fiber optic: FSE 200C1Y00 / FSE 200C2Y00, FSA 200C1Y00, FSG 200C1Y00, FSE 200E1Y00

order reference

10134541 Doubling lens increases the actual range (paires)

Doubling lens M2,6 (side view version)

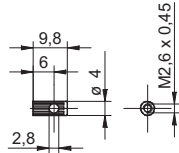

- Side view version
- Increases the actual range S_b by a factor of 6
- Contents: 2 pieces

For fiber optic: FSE 200C1Y00 / FSE 200C2Y00, FSA 200C1Y00, FSG 200C1Y00, FSE 200E1Y00

order reference

10134540 Doubling lens increases the actual range (paires)

Doubling lens M3

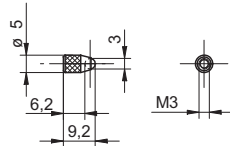

- Material: Ms / glass
- Increases the actual range S_b by a factor of 6
- Contents: 2 pieces

For fiber optic: FSE 200C1004

order reference

10119910 Doubling lens M3 increases the actual range (paires)

Doubling lens M4

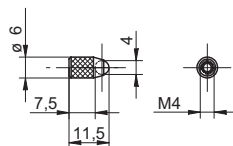

- Material: Ms / glass
- Increases the actual range S_b by a factor of 6
- Contents: 2 pieces

For fiber optic: FSE 200C1004

order reference

10119909 Doubling lens M4 increases the actual range (paires)

Focusing lens M3 Ø 0,1 mm

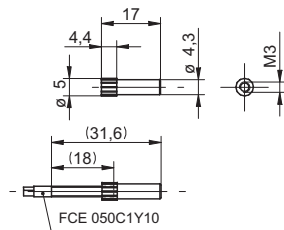

- Light spot \varnothing 0,1 mm at a distance of 4,6 mm

For fiber optic: FCE 050C1Y10 (empfohlen), FCE 200D1Y00, FCE 200D1Y01, FCE 200E1Y00

order reference

10134544 Focusing lens M3 Ø 0,1 mm

Focusing lens M3 Ø 0,4 mm

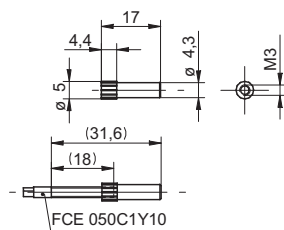

- Light spot \varnothing 0,4 mm at a distance of 7 mm

For fiber optic: FCE 050C1Y10 (empfohlen), FCE 200D1Y00, FCE 200D1Y01, FCE 200E1Y00

order reference

10134543 Focusing lens M3 Ø 0,4 mm

Focusing lens M3 Ø 2 mm

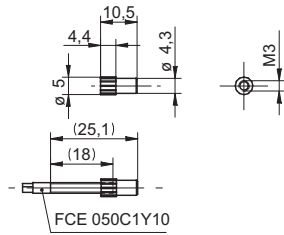

- Light spot Ø 2 mm at a distance of 19 mm

For fiber optic: FCE 050C1Y10 (empfohlen), FCE 200D1Y00, FCE 200D1Y01, FCE 200E1Y00

order reference

10134542 Focusing lens M3 Ø 2 mm (Paires)

Mounting bracket 1,1 mm

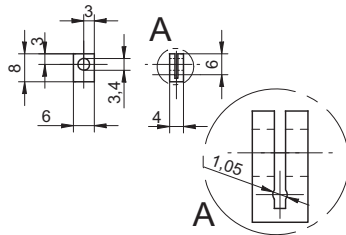

- Material: Aluminum

For fiber optic through beam type with 1,1 mm sheath diameters

order reference

10119912 Mounting bracket Ø 1,1 mm

Mounting bracket 2,2 mm

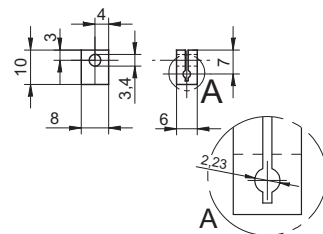

- Material: Aluminum

For fiber optic through beam type with 2,2 mm sheath diameters

order reference

10119911 Mounting bracket Ø 2,2 mm

Fiber optic mounting bracket for sensing head M3

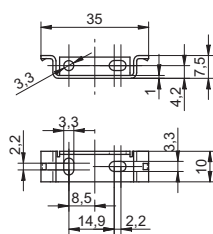

order reference

10134532 Fiber optic mounting bracket for sensing head M3

Mounting bracket for fiber optic sensors series 12

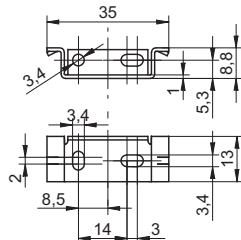

- Material: Steel
- Delivered with every plastic fiber optic sensor series 12

For use with FVDK 12

order reference

10145702 Mounting bracket for fiber optic sensors series 12

Mounting bracket for fiber optic sensors series 22

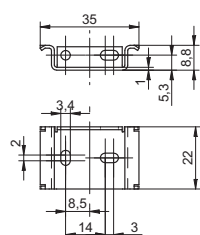

- Material: Steel
- Delivered with every plastic fiber optic sensor series 22

For use with FVDK 22

order reference

10125534 Mounting bracket for fiber optic sensors series 22

Mounting bracket for fiber optic sensors series 60

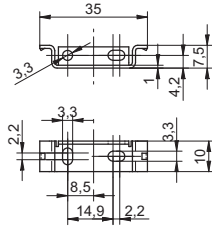

- Material: Steel
- Must be ordered separately for series 66 and series 67 sensors

For use with FVDK 66, FVDK 67

order reference

| | |
|----------|--|
| 10159806 | Mounting bracket for fiber optic sensors series 60, 67, 69, 80 |
|----------|--|

Reduction tube

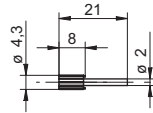

- Set of 2
- Delivered with every 1 mm diameter plastic fiber optic

order reference

| | |
|----------|----------------|
| 10140260 | Reduction tube |
|----------|----------------|

Fiber optic cable extension



- Reduction in range due to fiber optic extension: 2 m = approx. 25%
- Reduction in range due to fiber optic extension: 5 m = approx. 60%

order reference

| | |
|----------|--|
| 10145523 | Fiber optic cable extension 5 m hochflexibel |
| 10156738 | Fiber optic cable extension 2 m |
| 10158142 | Fiber optic cable extension 5 m |

Cutting tool



- Delivered with every plastic fiber optic

order reference

| | |
|----------|---------------------------------------|
| 10114652 | Cutting tool for plastic fiber optics |
|----------|---------------------------------------|

Adapter for photoelectric sensors series 30

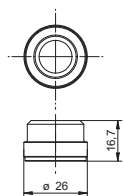

- Material: POM
- For use with fiber optic amplifier FZAM 30

order reference

| | |
|----------|--|
| 10102757 | Adapter series 30 |
| 10106042 | Adapter series 30 (abgewinkelte Lichtleiter) |

Adjusting plate for glass fiber optic sensors 18 (replace)

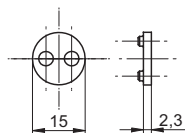

- Material: PETP
- For re-orders when lost
- Enclosed with every fiber optic type A

order reference

| | |
|----------|---------------------------|
| 10101958 | Adjusting plate series 18 |
|----------|---------------------------|

Cap nut for glass fiber optic sensors 15 (replace)

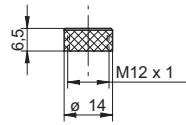

- Material: Nickel-plated brass
- For re-orders when lost
- Enclosed with every glass fiber optic of type B

For use with FVDM 15

order reference

10103230 Cap nut (Ersatz) for fiber optics series 15

Cap nut for glass fiber optic sensors 18 (replace)

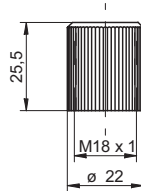

- Material: POM
- For re-orders when lost
- Enclosed with every glass fiber optic of type A

For use with FZAM 18

order reference

10101480 Cap nut (Ersatz) for fiber optics series 18

Glossary

P65

PNP

Teach-in

Analog

NPN



A

Active zone

The zone in which an object can be detected in front of the sensor. With diffuse sensors, this is approximately equivalent to the zone within the maximum sensing distance where the emitted beam and the reception angle intersect. With retro-reflective sensors, this is the zone from the emitted beam exit plane to the reflector and from there back to the receiver entrance plane. With through beam sensors, this is the zone from the emitted beam exit plane to the receiver entrance plane.

Actual range Sb

Like the nominal range S_n , but including an excess gain of 50% excess gain, i.e. the maximum distance at which reliable operation of the sensor is possible.

Adjustment aid

See «Output indicator»

Alarm output

Output function which indicates an inadequate signal level. The alarm output usually has a «dynamic» function which indicates whether the excess gain of 150% of the switching threshold was exceeded or not during the last light switching operation. It is also usually available as a «static» function: in this case, the alarm output indicates whether the current value of the signal is within the «critical range» between 100% and 150% of the switching threshold.

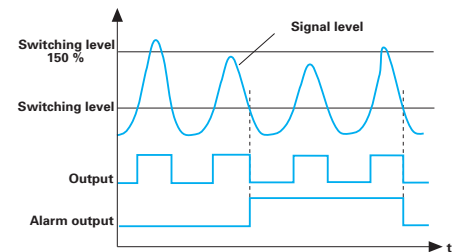

Ambient light immunity

Maximum permissible light intensity of the ambient light measured with a non-pulsed light source to IEC60947-5-2 and directed together with the receiver at a white reference paper which clearly covers the received beam. The light intensity is measured on the reference paper. In almost all sensor ranges, direct exposure of the white object to sunlight has no effect on the measurement. However, direct exposure of the received beam to sunlight almost certainly causes measuring errors.

Analog output

In contrast to the binary output with two possible output states, the analog output allows one continuous value such as a voltage or current to be emitted, resulting in a higher resolution of the measured values (see «Resolution»). Usually available as a voltage output 0 ... 10 V and current output 0 ... 20 mA or 4 ... 20 mA. The analog value can also be transmitted via a digital interface like RS 485.

B

Background suppression

Diffuse sensors usually operate by the triangulation principle. Thanks to this accurate distance measurement, a background may be located close behind the adjusted switching point without interfering with the measurement. The background is «suppressed».

Beam alignment, squint

Due to the addition of the production tolerances of the optical and mechanical components which cannot be compensated by adjustment during manufacture, a squint between the emitter and receiver beams of up to several degrees can occur. From a light distance of more than approx. 40 cm, retro-reflective sensors must usually be aligned. (Exception: OAx/OBx range is factory-adjusted.)

Beam-interrupting

Sensor class in which the presence of an object is detected by interruption of the light beam between an emitter (and possibly a reflector) and an associated receiver.

Binary output

Output which can assume two states, i.e. a switching output



Black-white (gray-white) offset

For diffuse sensors with foreground and background suppression, there is a reduction in the sensing distance on gray or black reference paper in comparison with white reference paper (foreground suppression: increased sensing distance). This is also known as the black-white and gray-white offset. The sensing distance diagram shows the reduction in the sensing distance to gray or black as a function of the adjusted sensing distance.

Blind region

Because the emitter and receiver axes are usually offset to each other, it is possible at very close distances to the object that no light emitted by the emitted beam is within the detected angle of the receiver. In this situation, the sensor is dark-switched, or «blind».

CE conformity

Designates compliance of the products with European Union directives. The CE marking of the products is conditional on metrological proof of their electromagnetic compatibility (EMC) according to IEC 61000-4-x standards. Please also note the information on the safety concept.

Closing delay

Output function which extends the dark-switched state of a binary sensor by a specific time. This causes a delay in the switching of a light-switching output and the dark-switching output switches later.

Color sensor LOGIPAL

A color sensor determines the magnitude of deviation of the color components between a taught-in color and the color reflected by the object. The switching output indicates whether at least one color component is outside the specified tolerance bands.

Color-based

Sensor class which detects a specific composition of the reflected light spectrum, meaning colors or gray scales (=contrasts). The distance and received light intensity are secondary.

Complementary output

Depending on the wiring the output can be used as a light-switching or dark-switching output. Both output versions are available simultaneously.

Correction factor

The material and the surface texture of the object affect the switching distance of a diffuse sensor with intensity difference. To determine the corrected switching distance, the following values must therefore be applied to the relative receiving signal (KFs) and as an approximation to the distance (KFd).

| Material | KFs | KFd |
|-----------------------|------|------|
| Kodak test card | 100% | 100% |
| Light, planed wood | 80% | 90% |
| Rough wood | 20% | 45% |
| Drawn aluminum | 25% | 50% |
| Cardboard, matt black | 7% | 26% |

Current consumption

Because photoelectric sensors usually operate with pulsed light, their operating current is not constant, but assumes a saw-tooth shape due to the internal smoothing of the current. An average value and a maximum value can be specified from this. Usually this is the maximum value.



| | |
|-------------------------------------|---|
| D Degree of remission | The degree of remission designates the diffuse proportion of the reflected light, i.e. without the reflective proportion. |
| Diffuse sensor | Diffuse sensors detect the presence of an object by illuminating it with emitted light, which is then reflected by the object to the receiver in a diffused form (remitted). |
| Direction of approach | With triangulation sensors, the approach of an object edge in the direction from the emitter lens to the receiver lens or the reverse can lead to incorrect results. The directions of approach from the front or the side cause no errors. |
| Distance-based | Sensor class in which the distance to the object is primarily assessed as the measured value. The intensity of the received signal, colors or gray scales are secondary. |
| ECOLAB approved | The sensors are resistant to many common cleaning agents. |
| EHEDG (Hygienic Design) | Sensors and mounting accessories meet the design criteria for hygienic applications. These sensors can be used in close proximity to foodstuff and facilitate the certification of the machine. |
| E EMC | All sensors undergo type testing with regard to their electromagnetic compatibility (EMC) according to the standards IEC61000-4-2, -3, -4. |
| Error correction | Photoelectric sensors usually operate by measuring pulsed light reflected by the object to the receiver. Because a measurement of this kind can be interfered with by various effects from the surroundings, e.g. rapid changes in the ambient light (switching fluorescent lighting on and off, welding sparks etc.), not all received light pulses appear in their correct magnitude, which could lead to switching errors. Fault correction evaluates the received pulses and only changes the switching state when a significant majority of pulses received within a time window indicate the need to change the switching state. |
| Excess gain | Because signal losses can occur in applications with optical sensors due to soiling of the optics and ageing of the light source, an excess gain must be allowed in the design of the application by presuming a shorter distance to the object than that indicated by the switching point. For reliable operation, an excess gain of at least 150% of the switching threshold is required. This distance correction can either be read off from the excess gain diagram or by exploiting the point at which the output indicator stops flashing. There are corresponding correction factors for diffuse sensors with intensity difference. |
| E External teach-in input | See «Teach-in» |
| FDA compliant | Consistent use of food compliant materials only. |
| Fiber optic sensor | An intensity-based sensor in which the emitter and receiver optics are replaced by an optical fiber connection. |



Focusing

Particularly for sensors operating by the triangulation principle, it is ideal when the size of the light spot is as small as possible. However, according to the laws of optics, it is only possible to bundle the light rays at one point of the light path, the so-called point of focus. For this reason, light sources are focused at a specific distance. This distance is optimum for the detection of very small objects.

Infrared light

Light in a long-wave range which is invisible to the human eye. In comparison with red light LEDs, IR LEDs can supply a higher radiated power. Unsuitable for use with plastic optical fibers, but suitable for glass optical fibers.

Intensity-based

Sensor class in which the light intensity impinging on the receiver is processed as a measured value (which is only an indirect measure of the distance to the object). The distance, colors or gray scales (= contrast) are secondary.

Inverted output

Depending on the wiring the output can be used as a light-switching or dark-switching output. Both output variants exist at the same time.

IO-Link

This is a communication standard for point-to-point connections between a master (connecting module) and a slave (sensor/actor). Non-screened standard sensor cables can be used as the transmission medium. Process data (analog/binary) and service data (parameters/diagnostics) can be transmitted by serial communication. IO-Link compatible sensors can be connected to existing I/O modules (without using serial communication). The advantage of IO-Link is the reduction in project planning and installation costs by a uniform interface and convenient parameter adjustment and management.

Laser diode

Light source featuring an exit zone of the light that is very small and can therefore be focused by downstream optics to form a very small measuring point (light spot). Another feature is that the light intensity is regulated by a monitor function and therefore remains practically unchanged during the service life of the laser diode.

Laser protection class

Lasers are subdivided into different protection classes according to their danger to the human eye:

- 1: Harmless
 - 1M: Harmless as long as not further bundled by optical measures
 - 2: Laser radiation exists only in the visible spectral range (400 ... 700 nm). Harmless for short periods of irradiation (max. 0.25s, as normally given by the natural protective reflex of the eyelid)
 - 2M: Like 2 as long as not further bundled by optical measures
-

Light/dark operation

Light operation: the output switches when the receiver receives light.
Dark operation: the output switches when the receiver receives no light.

Linearity deviation

Deviation from a proportional linear function (straight line). This is specified as an absolute value in mm or as a relative value as a percentage of the far limit of the measuring range.



Linking capability of outputs

Parallel connection of the outputs (OR function)

Sensors with identical output stages (NPN or PNP) can be connected in parallel if they are connected to the same power supply unit. The number of sensors which can be connected in parallel depends on the respective load current and the currents flowing through the internal pull-up and pull-down resistors (typically 3 mA). The sum of all load currents plus the sum of all internal currents must not exceed the specified maximum switching current of a single sensor.

Series connection of sensors (AND function)

Relay outputs may be connected in series. For sensors with electronic outputs, it is not permissible to switch on the supply of one sensor via the output of a preceding sensor and implement an AND function in this way. Because a sensor represents a high capacitive load, this would activate the short circuit protection.

M
Measuring range

The sensor supplies a valid measurement result within this range. The measuring range and the limits of the measuring range are adjustable in some sensors.

Minimum pulse length

Output function which forces a minimum length, e.g. 4 ms, for the two output states of a binary sensor, so that even a slow controller can detect such a state without difficulty. In contrast to release/response delay, an output state longer than the minimum impulse length is not extended.

Mounting distance

Distance between sensors (in diffuse sensors between the emitted light spots on the object) to prevent optical interference. Sensors with measures to reduce optical interference are not affected by this, but if the number of 3 is exceeded, the specified mounting distance for the next sensor but one is applicable.

Mounting instructions (MAL)

Some sensors are supplied with mounting instructions (MAL) which contain detailed notes on the connection and operation of the sensor

N
Nominal range S_n

The guaranteed maximum switching distance of retro-reflective sensors under ideal conditions (at +25° C, not soiled, sensors adjusted to each other).

NPN output

Binary open collector switching output with NPN transistor switching to 0 V. Consequently the load current flows from the switching output through the load resistance to +Vs. A suppressor diode is integrated and also an internal load resistor of approx. 10 kOhm ... 50 kOhm for measurement purposes.

O
Off delay

Output function which extends the light-switched state of a binary sensor by a specific time. As a result, the light-switched output drops out later and the dark-switched output is switched after a delay.

On delay

Output function which extends the dark-switched state of a binary sensor by a specific time. As a result the light-switching output switches after a delay and the dark-switching output will drop out later.

Optical fiber

Cable made of glass or plastic fibers which conveys the light of a photoelectric sensor and enables the detection of an object at a constrained point due to its small size.

Optical interference

Without countermeasures, pulsed light sources which illuminate the same point on an object can overlap, which can cause switching errors. Sensors which are insensitive to optical interference use methods by which the pulses can evade each other and minimize situations in which switching errors are possible. These methods allow operation of up to 3 sensors in the same operating range, i.e. each sensor may «see» 2 interfering neighbors. The method becomes more reliable the better the neighboring sensors can be «seen», enabling the evasion algorithms to be suitably adjusted.



Output current

Maximum permissible current load at the outputs. Because the short-circuit protection secures all outputs together in sensors with several outputs and therefore monitors the sum of all output currents, it must be observed that the output current specification refers to this sum.

Output indicator

Visual display on the sensor, usually a yellow LED which indicates the status of the sensor receiver. LED off: receiving signal < switching threshold, LED flashing: receiving signal between 100% ... 150% of the switching threshold, LED steady on: receiving signal > 150% of the switching threshold.

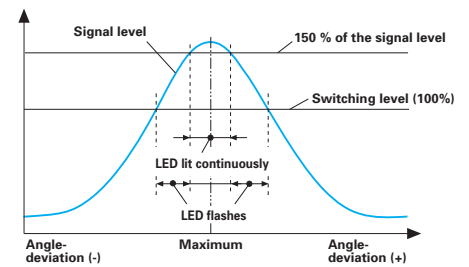

Overvoltage protection

Protection against brief voltage surges in accordance with the standard IEC 61000-4

D ParCon/PosCon line sensor

The line sensor is able to detect edges, widths and positions of objects without additional illumination. The measured value is issued with high accuracy as an analog value or via a serial interface.

PNP output

Binary open collector switching output with PNP transistor switching to +Vs. Consequently the load current flows from the switching output through the load resistance to 0 V. A suppressor diode is integrated and also an internal load resistor of approx. 10 kOhm ... 50 kOhm for measurement purposes.

Point source LED

Form of LED in which, in contrast to conventional LEDs, the light exit is not diffuse and distributed around the entire chip, but exits from the front in a circular and therefore clearly defined shape. A very small light spot can be created in this way (ideal for diffuse sensors with background suppression), similar to a laser, but at the expense of the total light intensity.

Polarization filter

Polarization filters only allow light to pass which is polarized in a specific plane. Retro-reflective sensors with polarization filters have polarization planes at the emitter and receiver twisted towards one another by 90°, so they only detect light which is reflected by a retro-reflector and depolarized in this way. For this reason, the light beam itself is always reliably interrupted by reflective objects (which leave the polarization plane unchanged).

proTect[⊕]

Unique impermeability concept – it guarantees that the sensors comply with protection class IP 68/IP 69K standards even after many temperature cycles and therefore have a long service life and high reliability.

Protection class (to IEC 60529)

IP 65: Protection against the penetration of dust and full protection against electrical contact. Protection against a water jet from any direction.
IP 67: Protection against the penetration of dust and full protection against electrical contact. Protection against water when the housing is immersed in water under specific pressure and time conditions.

Pulsed light

The sensitivity of a photoelectric sensor to ambient light can substantially be reduced by using pulsed light. On the one hand, the emitter LEDs can emit a higher peak power in pulsed operation, on the other, this makes differential measurement possible during which the difference in the received light with the light source switched on or off can be evaluated and non-pulsed light can be effectively compensated.



Push-pull output

Compared to the open collector output variants PNP (= load virtually 0V) and NPN (= load virtually +Vs), the push-pull output enables random switching of the load within the limits of the supply voltage. However, compared to the above named open collector output variants, it is not admissible to connect outputs in parallel.

R
Range sensor

Diffuse sensor with a switching output where two switching points can be set. This makes it possible to detect the presence of an object within a specified distance range.

Red light

Standard light color in the visible range, also suitable for use with plastic optical fibers. Advantage: due to its visibility, this improves the adjustment and monitoring of the application.

Reflection foil

See «(Retro-) reflector»

Relative receiving signal

The relative receiving signal is specified in diffuse sensors operating by the intensity difference principle. This signal represents the signal level received from a white object as a function of the distance. With the aid of this diagram, it is possible to determine the sensing distance for an object which is not white. The correction factor of the respective material is required for this purpose.

Release delay

Output function which extends the light-switched state of a binary sensor by a specific time. The light-switched output thereby opens later and the dark-switched output is switched after a delay.

Release time

The minimum time required for an object to have left the scanning range to cause a change in the output state. This change in state is immediate, unless a signal processing time is also specified by which this change in state is further delayed. Compliance with this release time is conditional on the switching threshold falling by max. 50%. If it is necessary for the sensor to take measures to reduce interference with other sensors, this time may be extended by up to 50 μ s.

Reproducibility (Repeat accuracy)

Max. deviation between two measurements under identical conditions (object position, soiling, temperature, duty cycle)

Residual ripple

Maximum proportion of alternating current which may be superimposed on the DC voltage supply with the momentary values remaining within the specified voltage supply range. Specified as a percentage of the mean value of +Vs.

Resolution

The smallest possible change in the measured value to cause a discernible change in the output signal.

Response time

The minimum time required for an object to be within the sensing distance to cause a change in the output state. This change in state is immediate, unless a signal processing time is also specified by which this change in state is further delayed. Compliance with this response time is conditional on an excess gain of at least 50% (the output indicator does not flash). If it is necessary for the sensor to take measures to reduce interference with other sensors, this time may be extended by up to 50 μ s.

(Retro-) reflector

Reflector that casts light back in the direction of incidence and as a result, in contrast to a mirror, requires no exact alignment. They are available in the form of a triple reflector or reflective film.

Reverse polarity protection

Protection against reverse polarity is generally ensured between any connections of the sensor unless otherwise specified (e.g. only supply connections).



S

Safety concept

The safety concept defines the technical, instructional and legal measures which ensure the user (machine manufacturer, owner, user) a high degree of safety when handling our components. The safety concept also serves as the basis for the CE marking of our products and can be obtained in German, English or French.

Sensing distance T_b

The sensing distance T_b ranges between the adjusted sensing distance and the blind region. The blind region defines the range immediately in front of the sensor where an object cannot be reliably detected. The sensing distance is therefore the distance where an object (Kodak white) is reliably detected.

Sensing distance T_w

The sensing distance T_w is the maximum achievable distance of a diffuse sensor measured at +25° C on white paper (Kodak Card No. 1 527 795) size 200 x 200 mm. At a maximum sensing distance of under 400 mm, the reference paper size is 100 x 100 mm. The excess gain necessary for reliable operation under ideal conditions (50%) is already included. Sensors with adjusting aids indicate this point by a continuously lit reception indicator.

Sensitivity adjustment

Sensors operating with intensity difference or as retro-reflective sensors may have adjustable sensitivity. The sensitivity can then be adjusted to the application using a potentiometer or by teach-in.

Sensor standard

The sensor standard IEC60947-5-2 forms the basis for all type tests on photoelectric sensors.

Shape-based

Sensor class which detects specific features of shape, e.g. edges, the height of newspaper copies, etc. The distance, received light intensity, colors or gray scales are secondary.

Short circuit protection

In optical sensors, short circuit protection is clocked (switches the output off for approx. 20 ms), self-resetting (attempts to switch the output again after the shut-off time has elapsed) and start-delayed (to handle capacitive loads of up to 50 nF occurring with longer cables).

Signal processing time

Delay between the detection of the future output state and its transmission to the output caused by signal processing. This has no effect on the maximum measurement frequency!

Smallest object

If the optical prerequisites for the detection of small objects are fulfilled, i.e. a sufficient signal difference exists, the following generally applies to the detection of moving objects with diffuse sensors: time in the scanning range > response time.
For retro-reflective sensors: time in the scanning range > release time.
The time in the scanning range t_e can be calculated by:
 $t_e = \text{distance in the scanning range} / \text{object speed}$

SmartReflect light barriers

Light barriers without reflectors. See section on SmartReflect light barriers.

Soiled lens indicator

See «Output indicator»

Start pulse suppression

Start pulse suppression suppresses undefined states during the starting phase by disabling all outputs during the first 20 ms after the voltage supply was switched on.



Switching hysteresis

Switching hysteresis is employed to prevent the normal fluctuations of the measured value close to the switching points of binary outputs from producing uncertain switching states (oscillating) at the output. A higher switching threshold to switch on the sensor is adjusted than to switch it off, resulting in a difference between the distances for switching on and off.

T Teach-in

Electronic teaching of an operating parameter (e.g. sensitivity adjustment) by pressing a button or via an external teach-in input. The «static teach-in» function is available as a standard feature. During teach-in the on position and off position are taught in and the sensor calculates the optimum switching point from this. The on position is always used as a normally open function and the off position always as a normally closed function. There is also a «dynamic teach-in» function, during which the maximum and minimum values of the results measured over a desired time are analyzed and an optimum switching threshold for this situation is automatically adjusted afterwards.

Teach-input external

See «Teach-in».

Temperature drift

In photoelectric sensors, the emitter light sources (apart from laser diodes), receiver elements and amplifiers are subject to certain thermal effects. This dependency of the measured values on the temperature is specified by the designation «temperature drift».

Test input

Some sensors provide a means of switching off the emitter for a function test by activating an input. If the sensor was previously switched to light, the output of the sensor must consequentially change to the dark switching state

Triangulation principle

Measuring principle used in diffuse sensors with background suppression and in distance-measuring sensors. The emitter, the object and the receiver form a triangular arrangement. The receiver is designed to enable measurement of the angle between the beams from the emitter to the object and from the object to the receiver. This angle depends on the distance to the object, which is determined by the position at which the received beam strikes the receiver element.

U UL test mark

The UL mark on a product indicates that samples of the complete product were tested by UL according to nationally acknowledged safety standards, that they are free from unacceptable, foreseeable risks such as fire, electric shocks and similar hazards and that the product was manufactured under UL supervision. Most products from Baumer electric are UL-listed. The file with the listed products can be viewed at [HYPERLINK "http://www.ul.com/database"](http://www.ul.com/database).

V Voltage supply range

The voltage supply must be within a specified voltage supply range at all times to ensure the correct function of the sensor.

Quick reference list

- FPDK 20P5101/S35A
- FEAM 08N1002/S35L
- FEDM 08P3001
- OADR 20I6480/S14F
- FPDM 12P3401
- FPDK 26R7103/S27
- FHDK10N1101
- FSE 050B2002
- ZADM 023H300.0002
- FZA 18A1001
- FSF 100A4003
- OADM 20S4571/S14F
- FUE 200D1Y00
- OZDM 16P3001/S14
- FEDK 26R7103
- IPS 70/100
- OHDM 20P6990/S14C
- FPDK 14N5101/S35A
- OHDM 16P5101/S14
- OZDM 16P1001
- OADM 13S7480/S35A
- ZADM 034I240.0021
- IPS 20/100
- VXS 1203M16RR
- FUE 050A2003
- FVDK 22P6101
- FHDK 10P3101/KS35
- FZDK 14N5101

| order reference | page | order reference | page | order reference | page |
|-----------------|----------|-----------------------|------|-----------------------|------|
| E | | ESW 33SH0500 | 423 | FFAM 17PTD1002/L | 191 |
| ES 14 PG7 | 420 | ESW 33SH1000 | 423 | FFDK 16P50Y0 | 193 |
| ES 14C PG7 | 420 | F | | FFDK 16P50Y5 | 193 |
| ES 18 PG7 | 420 | FADH 14I4470/IO | 28 | FFE 200D6Y00 | 326 |
| ES 18C PG7 | 420 | FADH 14I4470/KS34A/IO | 28 | FGLM 050P8001/S35L | 299 |
| ES 21 | 420 | FADH 14U4470/IO | 30 | FGLM 080P8001/S35L | 300 |
| ES 21A | 420 | FADH 14U4470/KS34A/IO | 30 | FGLM 120P8001/S35L | 301 |
| ES 22 | 421 | FADK 14I4470/IO | 32 | FGUM 020P8001/S35L | 290 |
| ES 22A | 421 | FADK 14I4470/S14/IO | 32 | FGUM 030P6901/S35A | 287 |
| ESG 32AH0200 | 421, 425 | FADK 14I4470/S35A/IO | 32 | FGUM 030P8001/S35L | 291 |
| ESG 32AH0200G | 421 | FADK 14U4470/IO | 34 | FGUM 050P6901/S35A | 288 |
| ESG 32AH0500 | 421, 425 | FADK 14U4470/S14/IO | 34 | FGUM 050P8001/S35L | 292 |
| ESG 32AH0500G | 421 | FADK 14U4470/S35A/IO | 34 | FGUM 080P6901/S35A | 289 |
| ESG 32AH1000 | 421, 425 | FADR 14I4470/S14/IO | 36 | FGUM 080P8001/S35L | 293 |
| ESG 32AH1000G | 421 | FADR 14U4470/S14/IO | 38 | FGUM 120P8001/S35L | 294 |
| ESG 32SH0200 | 421, 425 | FCE 050C1Y10 | 325 | FHCK 07N6901/KS35A | 96 |
| ESG 32SH0500 | 421, 425 | FCE 200C1Y00 | 325 | FHCK 07N6901 | 96 |
| ESG 32SH0500G | 421 | FCE 200C1Y01 | 325 | FHCK 07P6901/KS35A | 96 |
| ESG 32SH1000 | 421, 425 | FCE 200D1Y00 | 325 | FHCK 07P6901 | 96 |
| ESG 32SH1000G | 421 | FCE 200D1Y01 | 325 | FHDH 14G6901/IO | 124 |
| ESG 34AF0200 | 423, 439 | FCE 200E1Y00 | 325 | FHDH 14G6901/KS34A/IO | 124 |
| ESG 34AF0500 | 423, 439 | FEAM 08P1002/S35L | 262 | FHDH 14G6901/KS34A | 124 |
| ESG 34AF1000 | 423, 439 | FEAM 08P1002 | 262 | FHDH 14G6901 | 124 |
| ESG 34AF2500 | 423, 439 | FEAM 08P3002/S35L | 262 | FHDK 04G6101/KS35A | 94 |
| ESG 34AH0200 | 422 | FEAM 08P3002 | 262 | FHDK 04G6101 | 94 |
| ESG 34AH0200G | 423 | FEAM 18N3150/S14 | 278 | FHDK 04G6102/KS35A | 94 |
| ESG 34AH0500 | 422 | FEAM 18N3150 | 278 | FHDK 04G6102 | 94 |
| ESG 34AH0500G | 423 | FEAM 18P3150/S14 | 278 | FHDK 04G6111/KS35A | 94 |
| ESG 34AH1000 | 422 | FEAM 18P3150 | 278 | FHDK 04G6111 | 94 |
| ESG 34AH1000G | 423 | FECK 07N6901/KS35A | 254 | FHDK 04G6112/KS35A | 94 |
| ESG 34CH0200 | 422 | FECK 07N6901 | 254 | FHDK 04G6112 | 94 |
| ESG 34CH0200G | 423 | FECK 07P6901/KS35A | 254 | FHDK 07N6901/KS35A | 98 |
| ESG 34CH0500 | 422 | FECK 07P6901 | 254 | FHDK 07N6901 | 98 |
| ESG 34CH0500G | 423 | FEDK 07N6901/KS35A | 256 | FHDK 07P6901/KS35A | 98 |
| ESG 34CH1000G | 423 | FEDK 07N6901 | 256 | FHDK 07P6901 | 98 |
| ESG 34FH0200G | 423 | FEDK 07P6901/KS35A | 256 | FHDK 10G5120/S35A | 100 |
| ESG 34FH0500G | 423 | FEDK 07P6901 | 256 | FHDK 10G5120 | 100 |
| ESG 34FH1000G | 423 | FEDK 10N5101/S35A | 264 | FHDK 10G5121/S35A | 100 |
| ESG 34SH0200 | 422 | FEDK 10N5101 | 264 | FHDK 10G5121 | 100 |
| ESG 34SH0500 | 422 | FEDK 10P1101/KS35 | 264 | FHDK 10G5122/S35A | 100 |
| ESG 34SH1000 | 422 | FEDK 10P3101/KS35 | 264 | FHDK 10G5122 | 100 |
| ESW 31AH0200 | 422 | FEDK 10P5101/S35A | 264 | FHDK 10N1101/KS35 | 102 |
| ESW 31AH0200G | 422 | FEDK 10P5101 | 264 | FHDK 10N5101/S35A | 102 |
| ESW 31AH0500 | 422 | FEDK 14N5101/S35A | 270 | FHDK 10N5101 | 102 |
| ESW 31AH0500G | 422 | FEDK 14P5101/S35A | 270 | FHDK 10N5110/S35A | 104 |
| ESW 31AH1000 | 422 | FEDK 20N5101/S35A | 280 | FHDK 10N5110 | 104 |
| ESW 31AH1000G | 422 | FEDK 20P5101/S35A | 280 | FHDK 10N5150/S35A | 106 |
| ESW 31SH0200 | 422 | FEDM 08P1001/S35L | 258 | FHDK 10N5150 | 106 |
| ESW 31SH0200G | 422 | FEDM 08P1001 | 258 | FHDK 10N5160/S35A | 108 |
| ESW 31SH0500 | 422 | FEDM 08P1002/S35L | 260 | FHDK 10P1101/KS35 | 102 |
| ESW 31SH0500G | 422 | FEDM 08P1002 | 260 | FHDK 10P5101/S35A | 102 |
| ESW 31SH1000 | 422 | FEDM 08P3001/S35L | 258 | FHDK 10P5101 | 102 |
| ESW 33AF0200 | 424, 439 | FEDM 08P3001 | 258 | FHDK 10P5110/S35A | 104 |
| ESW 33AF0500 | 424, 439 | FEDM 08P3002/S35L | 260 | FHDK 10P5110 | 104 |
| ESW 33AF2500 | 424, 439 | FEDM 08P3002 | 260 | FHDK 10P5150/S35A | 106 |
| ESW 33AH0200 | 423 | FEDM 08P3002 | 260 | FHDK 10P5150 | 106 |
| ESW 33AH0200G | 424 | FEDM 12P5101/S35A | 268 | FHDK 10P5160/S35A | 108 |
| ESW 33AH0500 | 423 | FEDM 12P5101 | 268 | FHDK 10P5160/S35A | 108 |
| ESW 33AH0500G | 424 | FEDM 16P5101/S14 | 274 | FHDK 14N5101/S14 | 120 |
| ESW 33AH1000 | 423 | FEDM 16P5101 | 274 | FHDK 14N5101/S35A | 120 |
| ESW 33AH1000G | 424 | FEDM 16P5105/S14 | 274 | FHDK 14N5101 | 120 |
| ESW 33CH0200 | 423 | FEDM 16P5105 | 274 | FHDK 14N5104/S14 | 120 |
| ESW 33CH0500 | 423 | FFAK 16NTD1001/L | 190 | FHDK 14N5104/S35A | 120 |
| ESW 33CH0500G | 424 | FFAK 16PTD1001/L | 190 | FHDK 14N5104 | 120 |
| ESW 33FH0200G | 424 | FFAK 17NTD1001/L | 188 | FHDK 14N6901/S14 | 122 |
| ESW 33FH0500G | 424 | FFAK 17NTD1002/L | 189 | FHDK 14N6901/S35A | 122 |
| ESW 33FH1000G | 424 | FFAK 17PTD1001/L | 188 | FHDK 14N6901 | 122 |
| ESW 33SH0200 | 423 | FFAK 17PTD1002/L | 189 | FHDK 14P5101/S14 | 120 |
| | | FFAM 16PTD1002/L | 192 | FHDK 14P5101/S35A | 120 |
| | | | | FHDK 14P5101 | 120 |

| order reference | page | order reference | page | order reference | page |
|-----------------------|------|----------------------|----------|--------------------|------|
| FHDK 14P5104/S14 | 120 | FNDK 14G6902/S35A/IO | 206 | FPDR 14P5101/S14 | 234 |
| FHDK 14P5104/S35A | 120 | FNDK 14G6903/S14/IO | 206 | FPE 200C1Y00 | 330 |
| FHDK 14P5104 | 120 | FNDK 14G6903/S35A/IO | 206 | FPE 200C4Y00 | 330 |
| FHDK 14P6901/S14 | 122 | FNDK 14G6904/S14/IO | 206 | FPE 200D1Y00 | 330 |
| FHDK 14P6901/S35A | 122 | FNDK 14G6904/S35A/IO | 206 | FRDK 14N6901/S14 | 230 |
| FHDK 14P6901 | 122 | FNDR 14G6901/S14/IO | 210 | FRDK 14N6901/S35A | 230 |
| FHDK 20N6901/S35A | 136 | FNDR 14G6901/S14 | 210 | FRDK 14N6901 | 230 |
| FHDK 20P6901/S35A | 136 | FNDR 14G6902/S14/IO | 210 | FRDK 14P6901/S14 | 230 |
| FHDM 12N5001/S35A | 114 | FNDR 14G6902/S14 | 210 | FRDK 14P6901/S35A | 230 |
| FHDM 12N5001 | 114 | FNDR 14G6903/S14/IO | 210 | FRDK 14P6901 | 230 |
| FHDM 12P5001/S35A | 114 | FNDR 14G6903/S14 | 210 | FSA 200C1Y00 | 331 |
| FHDM 12P5001 | 114 | FOC 500C6Y00 | 195, 327 | FSAM 08D9002/S35 | 262 |
| FHDM 16N5001/S14 | 130 | FODK 23P90Y0/0500 | 194 | FSAM 08D9002 | 262 |
| FHDM 16N5001 | 130 | FODK 23P90Y0 | 194 | FSAM 18D9651/S14 | 278 |
| FHDM 16N5004/S14 | 130 | FODK 23P90Y5 | 194 | FSAM 18D9651 | 278 |
| FHDM 16N5004 | 130 | FPAM 18N3151/S14 | 246 | FSB 200C1Y00 | 331 |
| FHDM 16P5001/S14 | 130 | FPAM 18N3151 | 246 | FSC 200C2Y00 | 331 |
| FHDM 16P5001 | 130 | FPAM 18P3151/S14 | 246 | FSC 200C4Y00 | 331 |
| FHDM 16P5004/S14 | 130 | FPAM 18P3151 | 246 | FSCK 07D9601/KS35A | 254 |
| FHDM 16P5004 | 130 | FPCK 07N6901/KS35A | 218 | FSCK 07D9601 | 254 |
| FHDR 14G6901/S14/IO | 126 | FPCK 07N6901 | 218 | FSDK 07D9601/KS35A | 256 |
| FHDR 14G6901/S14 | 126 | FPCK 07P6901/KS35A | 218 | FSDK 07D9601 | 256 |
| FKDK 14G6901/S14 | 406 | FPCK 07P6901 | 218 | FSDK 10D9001/KS35 | 264 |
| FKDK 14G6901/S35A | 406 | FPDH 14N5101/KS34A | 232 | FSDK 10D9601/S35A | 264 |
| FKDK 14G6901 | 406 | FPDH 14N5101 | 232 | FSDK 10D9601 | 264 |
| FKDM 22N1901/S14F | 400 | FPDH 14P5101/KS34A | 232 | FSDK 14D9601/S35A | 270 |
| FKDM 22N1902/S14F | 401 | FPDH 14P5101 | 232 | FSDK 20D9601/S35A | 280 |
| FKDM 22N1911/S14F | 402 | FPDK 07N6901/KS35A | 220 | FSDM 08D9001/S35 | 258 |
| FKDM 22P1901/S14F | 400 | FPDK 07N6901 | 220 | FSDM 08D9001 | 258 |
| FKDM 22P1902/S14F | 401 | FPDK 07P6901/KS35A | 220 | FSDM 08D9002/S35 | 260 |
| FKDM 22P1911/S14F | 402 | FPDK 07P6901 | 220 | FSDM 08D9002 | 260 |
| FKDM 22P3901/S14F | 400 | FPDK 10N5130/S35A | 222 | FSDM 12D9601/S35A | 268 |
| FKDM 22P3902/S14F | 401 | FPDK 10N5130 | 222 | FSDM 12D9601 | 268 |
| FKE 200D1Y00 | 326 | FPDK 10N5135/S35A | 222 | FSDM 16D9601/S14 | 274 |
| FLC 200D2Y00 | 331 | FPDK 10N5135 | 222 | FSDM 16D9601 | 274 |
| FLDK 110C1003/S42 | 388 | FPDK 10P5130/S35A | 222 | FSE 025B1001 | 347 |
| FLDK 110G1003/S14 | 388 | FPDK 10P5130 | 222 | FSE 025B1003 | 348 |
| FLDK 110G1003/S42 | 388 | FPDK 10P5135/S35A | 222 | FSE 025B1007 | 347 |
| FLDK 110G1005/S14 | 388 | FPDK 10P5135 | 222 | FSE 025B2001 | 347 |
| FLDK 110G1006/S14 | 392 | FPDK 14N5101/S14 | 228 | FSE 025B2002 | 347 |
| FLDK 110G1010/S14 | 394 | FPDK 14N5101/S35A | 228 | FSE 025B2003 | 348 |
| FLDK 110G1903/S42 | 390 | FPDK 14N5101 | 228 | FSE 025B2006 | 347 |
| FLDM 170C1011/S42 | 386 | FPDK 14N5111/S14 | 228 | FSE 025B4003 | 347 |
| FLDM 170C1030/S42 | 384 | FPDK 14N5111/S35A | 228 | FSE 025B4004 | 348 |
| FLDM 170G1011/S42 | 386 | FPDK 14N5111 | 228 | FSE 025B4006 | 347 |
| FLDM 170G1030/S42 | 384 | FPDK 14P5101/S14 | 228 | FSE 050A1001 | 342 |
| FLE 200C1Y00 | 324 | FPDK 14P5101/S35A | 228 | FSE 050A1003 | 343 |
| FLE 200D1Y00 | 324 | FPDK 14P5101 | 228 | FSE 050A1006 | 342 |
| FNCK 07N6910/KS35A | 202 | FPDK 14P5111/S14 | 228 | FSE 050A2001 | 342 |
| FNCK 07N6910 | 202 | FPDK 14P5111/S35A | 228 | FSE 050A2002 | 342 |
| FNCK 07P6910/KS35A | 202 | FPDK 14P5111 | 228 | FSE 050A2003 | 343 |
| FNCK 07P6910 | 202 | FPDK 20N5101/S35A | 248 | FSE 050A2006 | 342 |
| FNDH 14G6901/IO | 208 | FPDK 20P5101/S35A | 248 | FSE 050A3020 | 343 |
| FNDH 14G6901/KS34A/IO | 208 | FPDM 12N3401/S35A | 224 | FSE 050A4003 | 342 |
| FNDH 14G6901/KS34A | 208 | FPDM 12N3401 | 224 | FSE 050A4004 | 343 |
| FNDH 14G6901 | 208 | FPDM 12N5101/S35A | 224 | FSE 050A4006 | 342 |
| FNDH 14G6902/IO | 208 | FPDM 12N5101 | 224 | FSE 050B1001 | 347 |
| FNDH 14G6902/KS34A/IO | 208 | FPDM 12P3401/S35A | 224 | FSE 050B1003 | 348 |
| FNDH 14G6902/KS34A | 208 | FPDM 12P3401 | 224 | FSE 050B1007 | 347 |
| FNDH 14G6902 | 208 | FPDM 12P5101/S35A | 224 | FSE 050B2001 | 347 |
| FNDH 14G6903/IO | 208 | FPDM 12P5101 | 224 | FSE 050B2002 | 347 |
| FNDH 14G6903/KS34A/IO | 208 | FPDM 16N5101/S14 | 240 | FSE 050B2003 | 348 |
| FNDH 14G6903/KS34A | 208 | FPDM 16N5101 | 240 | FSE 050B2006 | 347 |
| FNDH 14G6903 | 208 | FPDM 16P3921/S14 | 242 | FSE 050B4003 | 347 |
| FNDK 07N6910/KS35A | 204 | FPDM 16P5101/S14 | 240 | FSE 050B4004 | 348 |
| FNDK 07N6910 | 204 | FPDM 16P5101 | 240 | FSE 050B4006 | 347 |
| FNDK 07P6910/KS35A | 204 | FPDM 16P5105/S14 | 240 | FSE 100A1001 | 342 |
| FNDK 07P6910 | 204 | FPDM 16P5105 | 240 | FSE 100A1003 | 343 |
| FNDK 14G6902/S14/IO | 206 | FPDR 14N5101/S14 | 234 | FSE 100A1006 | 342 |

| order reference | page | order reference | page | order reference | page |
|-----------------|------|--------------------|----------|-----------------|------|
| FSE 100A2001 | 342 | FSF 100A2004 | 342 | FUE 050A2008 | 341 |
| FSE 100A2002 | 342 | FSF 100A2005 | 342 | FUE 050A2011 | 341 |
| FSE 100A2003 | 343 | FSF 100A3020 | 343 | FUE 050A3001 | 341 |
| FSE 100A2006 | 342 | FSF 100A3021 | 343 | FUE 050A4003 | 341 |
| FSE 100A3020 | 343 | FSF 100A3022 | 343 | FUE 050A4004 | 340 |
| FSE 100A4003 | 342 | FSF 100A4002 | 342 | FUE 050A4005 | 340 |
| FSE 100A4004 | 343 | FSF 100A4003 | 342 | FUE 050B1001 | 346 |
| FSE 100A4006 | 342 | FSF 100A4004 | 343 | FUE 050B1002 | 345 |
| FSE 100F6Y01 | 330 | FSG 200C1Y00 | 331 | FUE 050B1003 | 345 |
| FSE 200C1002 | 328 | FSL 500C6Y00 | 195, 331 | FUE 050B1008 | 346 |
| FSE 200C1004 | 328 | FTAR 013A000 | 426 | FUE 050B1011 | 346 |
| FSE 200C1013 | 330 | FTAR 014A000 | 426 | FUE 050B2001 | 346 |
| FSE 200C1Y00 | 328 | FTAR 020A000 | 426 | FUE 050B2002 | 345 |
| FSE 200C2002 | 328 | FTAR 038A000 | 426 | FUE 050B2003 | 345 |
| FSE 200C2004 | 328 | FTDF 005I040 | 429 | FUE 050B2004 | 345 |
| FSE 200C2Y00 | 328 | FTDF 012M050 | 429 | FUE 050B2008 | 346 |
| FSE 200C4001 | 329 | FTDF 020F020 | 428 | FUE 050B2011 | 346 |
| FSE 200C4002 | 329 | FTDF 020I175 | 429 | FUE 050B3001 | 346 |
| FSE 200C6Y00 | 330 | FTDF 035I395 | 429 | FUE 050B4003 | 345 |
| FSE 200C6Y01 | 330 | FTDF 035M050 | 430 | FUE 050B4004 | 346 |
| FSE 200C6Y02 | 330 | FTDF 050M234 | 430 | FUE 050B4005 | 345 |
| FSE 200C6Y15 | 330 | FTDL 005I000/... m | 429 | FUE 050C2Y10 | 326 |
| FSE 200D1Y50 | 329 | FTDL 020I000/... m | 429 | FUE 100A1001 | 341 |
| FSE 200D2Y00 | 329 | FTDL 035I000/... m | 429 | FUE 100A1002 | 340 |
| FSE 200D2Y50 | 329 | FTDL 050I000/... m | 429 | FUE 100A1003 | 340 |
| FSE 200D4Y00 | 329 | FTDL 050K000/... m | 428 | FUE 100A1008 | 341 |
| FSE 200E1Y00 | 328 | FTDL 610I000/... m | 429 | FUE 100A1011 | 341 |
| FSE 200E2Y00 | 329 | FTDR 005I040 | 428 | FUE 100A2001 | 341 |
| FSE 200F1Y00 | 329 | FTDR 008M030/01 | 430 | FUE 100A2002 | 340 |
| FSE 200F4Y00 | 329 | FTDR 008M030/21 | 430 | FUE 100A2003 | 340 |
| FSE 200F6Y00 | 330 | FTDR 010A014 | 426 | FUE 100A2004 | 340 |
| FSF 025B1001 | 348 | FTDR 010D020 | 426 | FUE 100A2008 | 341 |
| FSF 025B1005 | 347 | FTDR 015A038 | 427 | FUE 100A2011 | 341 |
| FSF 025B1007 | 347 | FTDR 017A027 | 427 | FUE 100A3001 | 341 |
| FSF 025B2001 | 348 | FTDR 017W035 | 428, 440 | FUE 100A4003 | 341 |
| FSF 025B2002 | 347 | FTDR 020I175 | 428 | FUE 100A4004 | 340 |
| FSF 025B2005 | 347 | FTDR 029A046 | 427 | FUE 100A4005 | 340 |
| FSF 025B2006 | 347 | FTDR 035I395 | 429 | FUE 100E2Y00 | 326 |
| FSF 025B4002 | 347 | FTDR 047A048 | 427 | FUE 200C1003 | 324 |
| FSF 025B4003 | 347 | FTDR 050R060 | 427, 440 | FUE 200C1004 | 324 |
| FSF 025B4004 | 348 | FTDR 051E051 | 427, 440 | FUE 200C1012 | 325 |
| FSF 050A1001 | 343 | FTDR 084A084 | 428 | FUE 200C2003 | 324 |
| FSF 050A1002 | 342 | FUA 200C1Y00 | 326 | FUE 200C2004 | 324 |
| FSF 050A1005 | 342 | FUB 200C1Y00 | 326 | FUE 200C2Y00 | 326 |
| FSF 050A2001 | 343 | FUC 200C2Y00 | 327 | FUE 200C4Y00 | 325 |
| FSF 050A2002 | 342 | FUE 025B1001 | 346 | FUE 200C6Y00 | 326 |
| FSF 050A2004 | 342 | FUE 025B1002 | 345 | FUE 200D1Y00 | 324 |
| FSF 050A2005 | 342 | FUE 025B1003 | 345 | FUE 200D2Y00 | 324 |
| FSF 050A3020 | 343 | FUE 025B1008 | 346 | FUE 200E1Y00 | 324 |
| FSF 050A3021 | 343 | FUE 025B1011 | 346 | FUE 200F1Y00 | 325 |
| FSF 050A3022 | 343 | FUE 025B2001 | 346 | FUF 025B1001 | 346 |
| FSF 050A4002 | 342 | FUE 025B2002 | 345 | FUF 025B1002 | 346 |
| FSF 050A4003 | 342 | FUE 025B2003 | 345 | FUF 025B1003 | 345 |
| FSF 050A4004 | 343 | FUE 025B2004 | 345 | FUF 025B1005 | 345 |
| FSF 050B1001 | 348 | FUE 025B2008 | 346 | FUF 025B1011 | 346 |
| FSF 050B1005 | 347 | FUE 025B2011 | 346 | FUF 025B2001 | 346 |
| FSF 050B1007 | 347 | FUE 025B3001 | 346 | FUF 025B2002 | 346 |
| FSF 050B2001 | 348 | FUE 025B4003 | 345 | FUF 025B2003 | 345 |
| FSF 050B2002 | 347 | FUE 025B4004 | 346 | FUF 025B2004 | 345 |
| FSF 050B2005 | 347 | FUE 025B4005 | 345 | FUF 025B2005 | 345 |
| FSF 050B2006 | 347 | FUE 050A1001 | 341 | FUF 025B2011 | 346 |
| FSF 050B4002 | 347 | FUE 050A1002 | 340 | FUF 025B3001 | 346 |
| FSF 050B4003 | 347 | FUE 050A1003 | 340 | FUF 025B4002 | 346 |
| FSF 050B4004 | 348 | FUE 050A1008 | 341 | FUF 025B4006 | 345 |
| FSF 100A1001 | 343 | FUE 050A1011 | 341 | FUF 025B4008 | 345 |
| FSF 100A1002 | 342 | FUE 050A2001 | 341 | FUF 050A1001 | 341 |
| FSF 100A1005 | 342 | FUE 050A2002 | 340 | FUF 050A1003 | 341 |
| FSF 100A2001 | 343 | FUE 050A2003 | 340 | FUF 050A1005 | 340 |
| FSF 100A2002 | 342 | FUE 050A2004 | 340 | FUF 050A1007 | 340 |

Quick reference list

Photoelectric sensors

| order reference | page | order reference | page | order reference | page |
|-------------------|----------|--------------------|----------|--------------------|------|
| FUF 050A1011 | 341 | FVDK 10P67Y0 | 316 | FZCK 07P6901/KS35A | 148 |
| FUF 050A2001 | 341 | FVDK 10P67Y2/S35A | 318 | FZCK 07P6901 | 148 |
| FUF 050A2003 | 341 | FVDK 10P67YM | 317 | FZDK 07N6901/KS35A | 150 |
| FUF 050A2004 | 340 | FVDK 10P67YR | 316 | FZDK 07N6901 | 150 |
| FUF 050A2005 | 340 | FVDK 10P67YS | 317 | FZDK 07P6901/KS35A | 150 |
| FUF 050A2007 | 340 | FVDK 10P81Y0/KS35A | 313 | FZDK 07P6901 | 150 |
| FUF 050A2011 | 341 | FVDK 10P81Y0 | 313 | FZDK 10N1101/KS35 | 156 |
| FUF 050A3001 | 341 | FVDK 10P82Y0/KS35A | 313 | FZDK 10N5101/S35A | 156 |
| FUF 050A4002 | 341 | FVDK 10P82Y0 | 313 | FZDK 10N5101 | 156 |
| FUF 050A4004 | 340 | FVDK 10P83Y0/KS35A | 313 | FZDK 10P1101/KS35 | 156 |
| FUF 050A4005 | 340 | FVDK 10P83Y0 | 313 | FZDK 10P5101/S35A | 156 |
| FUF 050B1001 | 346 | FVDK 12N6101/S35A | 319 | FZDK 10P5101 | 156 |
| FUF 050B1002 | 346 | FVDK 12N6401/S35A | 319 | FZDK 14N5101/S35A | 164 |
| FUF 050B1003 | 345 | FVDK 12P6101/S35A | 319 | FZDK 14N5101 | 164 |
| FUF 050B1005 | 345 | FVDK 12P6101 | 319 | FZDK 14P5101/S14 | 164 |
| FUF 050B1011 | 346 | FVDK 12P6401/S35A | 319 | FZDK 14P5101/S35A | 164 |
| FUF 050B2001 | 346 | FVDK 12P6401 | 319 | FZDK 14P5101 | 164 |
| FUF 050B2002 | 346 | FVDK 12P6410/S35A | 320 | FZDK 20N5101/S35A | 180 |
| FUF 050B2003 | 345 | FVDK 12P6501/S35A | 319 | FZDK 20P5101/S35A | 180 |
| FUF 050B2004 | 345 | FVDK 22P6101/S14C | 321 | FZDM 08P1001/S35L | 152 |
| FUF 050B2005 | 345 | FVDK 22P6101 | 321 | FZDM 08P1001 | 152 |
| FUF 050B2011 | 346 | FVDK 22P6401/S14C | 321 | FZDM 08P1002/S35L | 152 |
| FUF 050B3001 | 346 | FVDK 22P6401 | 321 | FZDM 08P1002 | 152 |
| FUF 050B4002 | 346 | FVDK 22P6420 | 321 | FZDM 08P3001/S35L | 152 |
| FUF 050B4006 | 345 | FVDK 22P6501/S14C | 321 | FZDM 08P3001 | 152 |
| FUF 050B4008 | 345 | FVDM 15N5103/S14 | 344 | FZDM 08P3002/S35L | 152 |
| FUF 100A1001 | 341 | FVDM 15N5103 | 344 | FZDM 08P3002 | 152 |
| FUF 100A1003 | 341 | FVDM 15P5103/S14 | 344 | FZDM 16N5101/S14 | 168 |
| FUF 100A1005 | 340 | FVDM 15P5103 | 344 | FZDM 16N5101 | 168 |
| FUF 100A1007 | 340 | FVDM 15P5130/S14 | 344 | FZDM 16P5101/S14 | 168 |
| FUF 100A1011 | 341 | FVDM 15P5130 | 344 | FZDM 16P5101 | 168 |
| FUF 100A2001 | 341 | FWDK 10U84Y0 | 322 | | |
| FUF 100A2003 | 341 | FWE 200C1Y00 | 328 | H | |
| FUF 100A2004 | 340 | FWE 200C2Y00 | 328 | HI17-1H | 440 |
| FUF 100A2005 | 340 | FZAM 08P1001/S35L | 154 | | |
| FUF 100A2007 | 340 | FZAM 08P1001 | 154 | O | |
| FUF 100A2011 | 341 | FZAM 08P1002/S35L | 154 | OADK 25I7480/S14C | 72 |
| FUF 100A3001 | 341 | FZAM 08P1002 | 154 | OADK 25U7480/S14C | 72 |
| FUF 100A4002 | 341 | FZAM 08P3001/S35L | 154 | OADM 12I6430/S35A | 40 |
| FUF 100A4004 | 340 | FZAM 08P3001 | 154 | OADM 12I6460/S35A | 40 |
| FUF 100A4005 | 340 | FZAM 08P3002/S35L | 154 | OADM 12U6430/S35A | 40 |
| FUF 010A2002 | 340 | FZAM 08P3002 | 154 | OADM 12U6460/S35A | 40 |
| FUF 010B2001 | 345 | FZAM 12N1104/S14 | 162 | OADM 12U6460/S35A | 40 |
| FUF 010B2002 | 345 | FZAM 12N1104 | 162 | OADM 13I6475/S35A | 42 |
| FUL 200D2Y00 | 195, 327 | FZAM 12N3104/S14 | 162 | OADM 13I6575/S35A | 42 |
| FVDK 10N5101/S35A | 312 | FZAM 12N3104 | 162 | OADM 13I7480/S35A | 42 |
| FVDK 10N5101 | 312 | FZAM 12P1104/S14 | 162 | OADM 13I7580/S35A | 42 |
| FVDK 10N66Y0/S35A | 314 | FZAM 12P1104 | 162 | OADM 13I7730/S35A | 50 |
| FVDK 10N66Y0 | 314 | FZAM 12P3104/S14 | 162 | OADM 13I7745/S35A | 50 |
| FVDK 10N66YM | 315 | FZAM 12P3104 | 162 | OADM 13I7760/S35A | 50 |
| FVDK 10N66YR | 314 | FZAM 18N1150/S14 | 178, 337 | OADM 13S6475/S35A | 48 |
| FVDK 10N66YS | 315 | FZAM 18N1150 | 178, 337 | OADM 13S6575/S35A | 48 |
| FVDK 10N67Y0/S35A | 316 | FZAM 18N1155 | 176, 336 | OADM 13S7480/S35A | 48 |
| FVDK 10N67Y0 | 316 | FZAM 18N6460/S14 | 174, 338 | OADM 13S7580/S35A | 48 |
| FVDK 10N67Y2 | 318 | FZAM 18N6460 | 174, 338 | OADM 13T6475/S35A | 46 |
| FVDK 10N67YM | 317 | FZAM 18P1150/S14 | 178, 337 | OADM 13T6575/S35A | 46 |
| FVDK 10N67YR | 316 | FZAM 18P1150 | 178, 337 | OADM 13T7480/S35A | 46 |
| FVDK 10N67YS | 317 | FZAM 18P1155 | 176, 336 | OADM 13T7580/S35A | 46 |
| FVDK 10N81Y0 | 313 | FZAM 18P6460/S14 | 174, 338 | OADM 13U6475/S35A | 44 |
| FVDK 10N82Y0 | 313 | FZAM 18P6460 | 174, 338 | OADM 13U6575/S35A | 44 |
| FVDK 10N83Y0 | 313 | FZAM 30N5001 | 339 | OADM 13U7480/S35A | 44 |
| FVDK 10P5101/S35A | 312 | FZAM 30N5002 | 182 | OADM 13U7580/S35A | 44 |
| FVDK 10P5101 | 312 | FZAM 30N5004 | 339 | OADM 13U7730/S35A | 52 |
| FVDK 10P66Y0/S35A | 314 | FZAM 30P5001 | 339 | OADM 13U7745/S35A | 52 |
| FVDK 10P66Y0 | 314 | FZAM 30P5002 | 182 | OADM 13U7760/S35A | 52 |
| FVDK 10P66YM | 315 | FZAM 30P5003 | 182 | OADM 20I2441/S14C | 54 |
| FVDK 10P66YR | 314 | FZAM 30P5004 | 339 | OADM 20I2460/S14C | 54 |
| FVDK 10P66YS | 315 | FZCK 07N6901/KS35A | 148 | OADM 20I2472/S14C | 56 |
| FVDK 10P67Y0/S35A | 316 | FZCK 07N6901 | 148 | OADM 20I2480/S14C | 56 |
| | | | | OADM 20I6441/S14F | 58 |

| order reference | page |
|--------------------|------|
| OADM 20I6460/S14F | 58 |
| OADM 20I6472/S14F | 58 |
| OADM 20I6480/S14F | 60 |
| OADM 20I6481/S14F | 60 |
| OADM 20I6541/S14F | 58 |
| OADM 20I6560/S14F | 58 |
| OADM 20I6572/S14F | 58 |
| OADM 20I6580/S14F | 60 |
| OADM 20I6581/S14F | 60 |
| OADM 20I6591 | 66 |
| OADM 20I6592 | 66 |
| OADM 20I6593 | 66 |
| OADM 20S4440/S14F | 62 |
| OADM 20S4460/S14F | 62 |
| OADM 20S4470/S14F | 62 |
| OADM 20S4471/S14F | 64 |
| OADM 20S4481/S14F | 64 |
| OADM 20S4540/S14F | 62 |
| OADM 20S4560/S14F | 62 |
| OADM 20S4570/S14F | 62 |
| OADM 20S4571/S14F | 64 |
| OADM 20S4581/S14F | 64 |
| OADM 20U2441/S14C | 54 |
| OADM 20U2460/S14C | 54 |
| OADM 20U2472/S14C | 56 |
| OADM 20U2480/S14C | 56 |
| OADM 21I6480/S14F | 70 |
| OADM 21I6481/S14F | 70 |
| OADM 21I6580/S14F | 70 |
| OADM 21I6581/S14F | 70 |
| OADM 250I1101/S14C | 74 |
| OADM 250U1101/S14C | 74 |
| OADM 260I1101/S14C | 76 |
| OADR 20I6465/S14F | 68 |
| OADR 20I6475/S14F | 68 |
| OADR 20I6485/S14F | 68 |
| OADR 20I6565/S14F | 68 |
| OADR 20I6575/S14F | 68 |
| OADR 20I6585/S14F | 68 |
| OBDM 12N6910/S35A | 83 |
| OBDM 12N6920/S35A | 84 |
| OBDM 12N6930/S35A | 85 |
| OBDM 12N6940/S35A | 86 |
| OBDM 12N6950/S35A | 87 |
| OBDM 12P6910/S35A | 83 |
| OBDM 12P6920/S35A | 84 |
| OBDM 12P6930/S35A | 85 |
| OBDM 12P6940/S35A | 86 |
| OBDM 12P6950/S35A | 87 |
| OEDK 10N5105/S35A | 266 |
| OEDK 10N5105 | 266 |
| OEDK 10P5105/S35A | 266 |
| OEDK 10P5105 | 266 |
| OEDK 14P5101/S35A | 272 |
| OEDM 16P3401/S14 | 276 |
| OEDM 16P3401 | 276 |
| OEDM 16P5101/S14 | 276 |
| OEDM 16P5101 | 276 |
| OGUM 030P8001/S35L | 295 |
| OGUM 050P8001/S35L | 296 |
| OGUM 080P8001/S35L | 297 |
| OGUM 120P8001/S35L | 298 |
| OHDK 10N5101/S35A | 110 |
| OHDK 10N5101 | 110 |
| OHDK 10N5150/S35A | 112 |
| OHDK 10P5101/S35A | 110 |
| OHDK 10P5101 | 110 |
| OHDK 10P5150/S35A | 112 |
| OHDK 14N5101/S14 | 128 |

| order reference | page |
|-------------------|----------|
| OHDK 14N5101/S35A | 128 |
| OHDK 14N5101 | 128 |
| OHDK 14P5101/S14 | 128 |
| OHDK 14P5101/S35A | 128 |
| OHDK 14P5101 | 128 |
| OHDK 25G6911/S14 | 142 |
| OHDK 25G6912/S14C | 142 |
| OHDK 25G6921/S14 | 140 |
| OHDM 12N6901/S35A | 116 |
| OHDM 12P6901/S35A | 116 |
| OHDM 13N6901/S35A | 118 |
| OHDM 13N6951/S35A | 118 |
| OHDM 13P6901/S35A | 118 |
| OHDM 13P6951/S35A | 118 |
| OHDM 16N5001/S14 | 132 |
| OHDM 16N5001 | 132 |
| OHDM 16N5651 | 134 |
| OHDM 16P5001/S14 | 132 |
| OHDM 16P5001 | 132 |
| OHDM 16P5002/S14 | 132 |
| OHDM 16P5012/S14 | 132 |
| OHDM 16P5012 | 132 |
| OHDM 16P5651 | 134 |
| OHDM 20P6990/S14C | 138 |
| ONDK 25G6911/S14 | 212 |
| OPDK 14P1902/S14 | 238 |
| OPDK 14P1902/S35A | 238 |
| OPDK 14P1902 | 238 |
| OPDK 14P1903/S14 | 238 |
| OPDK 14P1903/S35A | 238 |
| OPDK 14P1903 | 238 |
| OPDK 14P3902/S14 | 238 |
| OPDK 14P3902/S35A | 238 |
| OPDK 14P3902 | 238 |
| OPDK 14P3903/S14 | 238 |
| OPDK 14P3903/S35A | 238 |
| OPDK 14P3903 | 238 |
| OPDK 14P5901/S14 | 236 |
| OPDK 14P5901/S35A | 236 |
| OPDK 14P5901 | 236 |
| OPDM 12N5101/S35A | 226 |
| OPDM 12P5101/S35A | 226 |
| OPDM 12P5101 | 226 |
| OPDM 12P5102/S35A | 226 |
| OPDM 12P5103/S35A | 226 |
| OPDM 12P5104/S35A | 226 |
| OPDM 16P5102/S14 | 244 |
| OPDM 16P5102 | 244 |
| OPDM 16P5103/S14 | 244 |
| OSDK 10D9005/S35A | 266 |
| OSDK 10D9005 | 266 |
| OSDK 14D9001/S35A | 272 |
| OSDM 16D9601/S14 | 276 |
| OSDM 16D9601 | 276 |
| OZDK 10N5101/S35A | 158, 410 |
| OZDK 10N5101 | 158, 410 |
| OZDK 10N5150/S35A | 160, 408 |
| OZDK 10N5150 | 160, 408 |
| OZDK 10P5101/S35A | 158, 410 |
| OZDK 10P5101 | 158, 410 |
| OZDK 10P5150/S35A | 160, 408 |
| OZDK 10P5150 | 160, 408 |
| OZDK 14N1901/S14 | 166, 412 |
| OZDK 14N1901/S35A | 166, 412 |
| OZDK 14N1901 | 166, 412 |
| OZDK 14P1901/S14 | 166, 412 |
| OZDK 14P1901/S35A | 166, 412 |
| OZDK 14P1901 | 166, 412 |
| OZDM 16N1001/S14 | 170, 416 |

| order reference | page |
|-------------------|----------|
| OZDM 16N1001 | 170, 416 |
| OZDM 16P1001/S14 | 170, 416 |
| OZDM 16P1001 | 170, 416 |
| OZDM 16P1901/S14 | 172, 414 |
| OZDM 16P1901 | 172, 414 |
| OZDM 16P3001/S14 | 170, 416 |
| OZDM 16P3001 | 170, 416 |
| V | |
| VS CS100M03I10EP | 356 |
| VS CS100M03I16EP | 356 |
| VS CS100M03W10EP | 356 |
| VS CS100M03W16EP | 356 |
| VS ID100M03W10RP | 354 |
| VS ID100M03W16RP | 354 |
| VS ID110M03I10EP | 355 |
| VS ID110M03W10EP | 355 |
| VS XC100M03X00EP | 360 |
| VS XC100M12X00EP | 360 |
| VS XC100M20X00EP | 360 |
| VS XC200M03X00EP | 362 |
| VS XC200M12X00EP | 362 |
| VS XC200M20X00EP | 362 |
| VS XF100M03W10EP | 358 |
| VS XF100M03W16EP | 358 |
| VS XF200M03I10P | 359 |
| VS XF200M03W10P | 359 |
| VS XF200M03W16P | 359 |
| Z | |
| ZADM 023H151.0001 | 374 |
| ZADM 023H151.0002 | 374 |
| ZADM 023H151.0011 | 374 |
| ZADM 023H151.0012 | 374 |
| ZADM 023H300.0001 | 374 |
| ZADM 023H300.0002 | 374 |
| ZADM 023H300.0011 | 374 |
| ZADM 023H300.0012 | 374 |
| ZADM 023H351.0001 | 374 |
| ZADM 023H351.0002 | 374 |
| ZADM 023H351.0011 | 374 |
| ZADM 023H351.0012 | 374 |
| ZADM 023H871.0001 | 376 |
| ZADM 023H871.0002 | 376 |
| ZADM 023H871.0011 | 376 |
| ZADM 023H871.0012 | 376 |
| ZADM 034I220.0021 | 370 |
| ZADM 034I220.0022 | 370 |
| ZADM 034I240.0001 | 368 |
| ZADM 034I240.0021 | 368 |
| ZADM 034P240.6901 | 372 |
| ZADM 034P240.6921 | 372 |

Worldwide presence.

We strive to be close to our customers all around the world. We listen to them, and then after understanding their needs, we provide the best solution. Worldwide customer service for us starts with on-the-spot personal discussions and qualified consultation. Our application engineers speak your language and strive from the start, through an interactive problem analysis, to offer comprehensive and user-compatible solutions. The worldwide Baumer sales organizations guarantee a high level of readiness to deliver.



Africa

Algeria
Cameroon
Côte d'Ivoire
Egypt
Morocco
Reunion
South Africa

America

Brazil
Canada
Colombia
Mexico
United States
Venezuela

Asia

Bahrain
China
India
Indonesia
Israel
Japan
Kuwait
Malaysia
Oman
Philippines
Qatar
Saudi Arabia
Singapore
South Korea
Taiwan
Thailand
UAE

Europe

Austria
Belgium
Bulgaria
Croatia
Czech Republic
Denmark
Finland
France
Germany
Greece
Hungary
Italy
Malta
Martinique
Netherlands
Norway
Poland
Portugal
Romania
Russia
Serbia
Slovakia
Slovenia
Spain
Sweden
Switzerland
Turkey
United Kingdom

Oceania

Australia
New Zealand



For more information
about our worldwide
locations go to:
www.baumer.com/worldwide

Our entire portfolio

Baumer has the perfect solution for every application.

Presence detection

- Inductive sensors
- Photoelectric sensors
- Ultrasonic sensors
- Capacitive sensors
- Magnetic sensors
- Precision mechanical switches

Distance measurement

- Inductive sensors
- Photoelectric sensors
- Ultrasonic sensors
- Linear encoders without bearings
- Cable-pull encoders

Angle measurement / Rotary encoders

- Absolute encoders
- Incremental encoders
- HeavyDuty encoders
- Bearingless encoders
- Format alignment
- Inclination sensors

Identification / Image processing

- Industrial Cameras
- Vision Sensors

Process instrumentation

- Level measurement
- Temperature measurement
- Pressure measurement
- Conductivity measurement
- Force/strain sensors
- Counters and process displays



Baumer Group
International Sales
P.O. Box · Hummelstrasse 17 · CH-8501 Frauenfeld
Phone +41 (0)52 728 1122 · Fax +41 (0)52 728 1144
sales@baumer.com · www.baumer.com

Represented by: